

The American rifle

Townsend Whelen

THE AMERICAN RIFLE

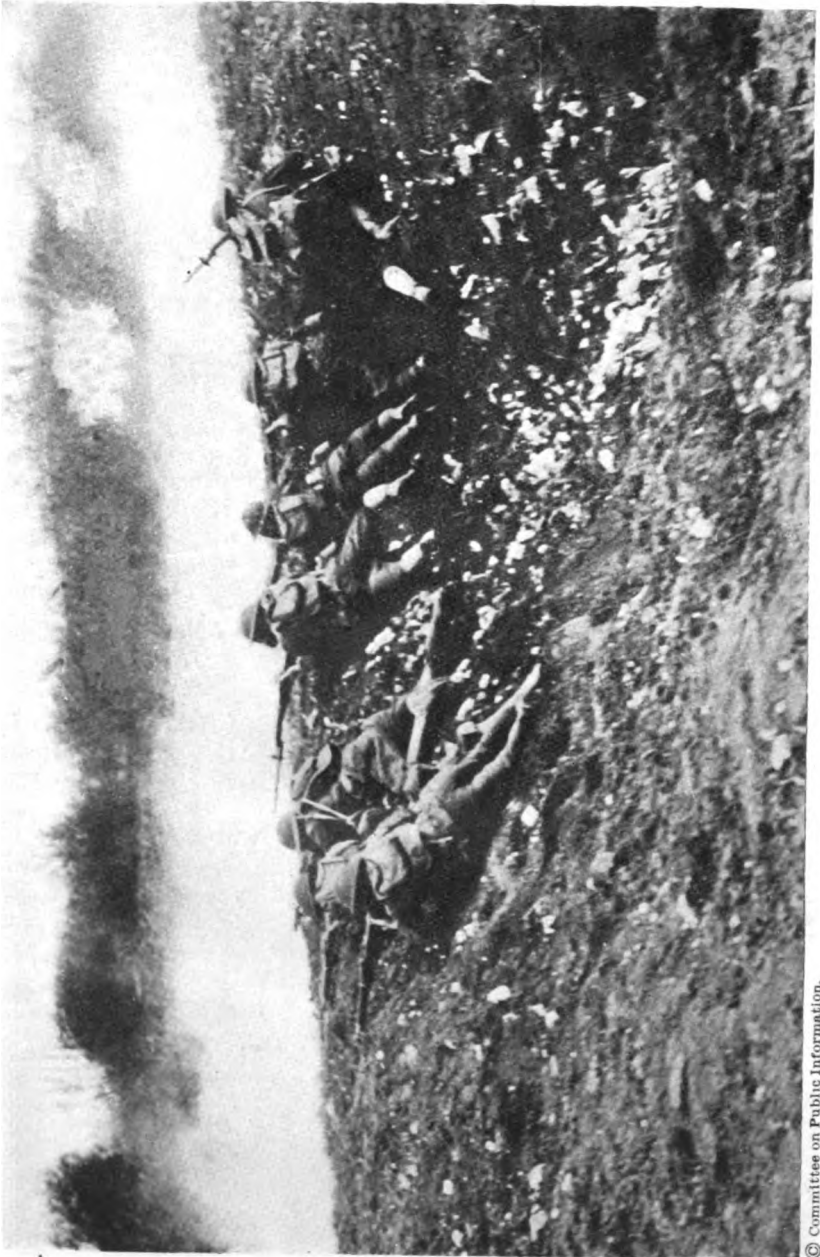

AMERICAN RIFLEMEN, 1918

© Committee on Public Information.

THE AMERICAN RIFLE

*A TREATISE, A TEXT BOOK, AND A BOOK
OF PRACTICAL INSTRUCTION IN
THE USE OF THE RIFLE*

1106E

BY
MAJOR TOWNSEND WHELEN
ORDNANCE OFFICER, 79TH DIVISION, N. A.
(CAPTAIN, 29TH U. S. INFANTRY)



NEW YORK
THE CENTURY CO.
1918

27

Copyright, 1918, by
THE CENTURY Co.

Published, October, 1918



I DEDICATE THIS WORK TO
THE MEMORY OF

FRANKLIN W. MANN,

who has contributed more to the science of rifle
shooting during the past decade than any
other person, an exact experimenter,
a truthful rifleman, and a friend;

AND TO

ROBERT AINSLIE KANE,

a rifleman, a nobleman, and, more than either, a
man. Both died, their lifework uncompleted.
I, their friend, have tried to carry it on.

INTRODUCTION

This work represents the study and labor of the twenty-five best years of my life. I have written it because I believe that there is great need for such a book, a book which will help to make us again what we were a century ago before commercialism and life in cities robbed our young men of most of their primitive virtues—a Nation of Riflemen. A nation skilled in the use of the rifle need never fear for their liberties, nor for those hidden dangers which accompany an effete civilization. Ever since the days when our frontiersmen won their way, and settled our country with rifle and axe the former has been the symbol of real manhood, and so it must always be. Rifle shooting for sport or war has always been associated with the red blooded men, and rifle competitions have never had the faintest trace of professionalism attached.

In many years of careful work and study I have gained a knowledge of our national arm which it does not seem right that I should keep to myself, especially at a time when my country needs a most thorough dissemination of knowledge on the subject. I have had to write the book before I wanted to, and under great pressure, at the start of my country's participation in the Great War. By profession a soldier I must needs hurry it to completion before it is perhaps too late. I therefore ask for its consideration by the reader.

This is not a military book. It is rather a book for the great mass of American manhood in whom the love for adventure, the primitive desire for treading the waste places, and the love of country have not been entirely sapped. But the soldier will find in it much dealing with the principal weapon of the Infantrymen which has not heretofore been available.

The book is mine in the main. The experiments detailed were mostly conducted by myself unaided, although I have incorporated the results of a number of experiments and much research work undertaken by Dr. Franklin W. Mann, as set forth in his book "The Bullet's Flight." I alone am responsible for the opinions expressed herein, and I believe that I have told the truth.

I desire to acknowledge the assistance that I have received from the following of my friends:

Franklin W. Mann.	Walter G. Hudson.	Paul B. Jenkins.
Robert A. Kane.	Kellog K. V. Casey.	T. G. Samworth.
Harry M. Pope.	Adolph O. Neidner.	J. R. Mattern.

Many times this little coterie of riflemen have assisted me, encouraged me, and helped to put me on the right track.

I have tried to arrange the sequence of the chapters in such a manner that a careful reading of the book in the order presented will permit of a full understanding of the text, often a difficult matter in a technical work. Some of the matter presented herewith has appeared under my signature in various magazines devoted to rifles and rifle shooting, but the larger part of it is new matter, not found elsewhere. At the same time it has been necessary to include much matter which is common knowledge among experienced riflemen and ballisticians, and great precautions have been taken to see that this matter has been presented truthfully, and without exaggeration. I have received considerable assistance from the various arms and ammunition companies in the mechanical preparation of the work, but no monetary consideration whatever, and the reader can regard the work as absolutely free from commercialism.

TOWNSEND WHELEN.

Headquarters, 79th Division.
Office of the Ordnance Officer,
Camp Meade, Md.

CONTENTS

PART I

HISTORICAL, INTRODUCTORY, CONSTRUCTION AND BALLISTICS

CHAPTER	PAGE
I THE HISTORY OF THE RIFLE IN AMERICA	3
II THE A. B. C. OF RIFLE BALLISTICS	15
III THE NOMENCLATURE AND CLASSIFICATION OF AMERICAN RIFLES	20
IV THE AMERICAN RIFLES	23
V BARRELS	129
VI STOCKS, FOREARMS, BALANCE, AND WEIGHT	136
VII THE SIGHTS	146
VIII SIGHT ADJUSTMENT	170
IX TELESCOPE SIGHTS	179
X BULLETS	197
XI CARTRIDGES	208
XII MODERN RIFLE POWDERS	284
XIII RELOADING AMMUNITION	338
XIV TRAJECTORY	360
XV KILLING POWER	364
XVI ELEVATION	374
XVII ACCURACY	382
XVIII ACCURACY LIFE AND MOBILUBRICANT	403
XIX ZERO ELEVATION, BARREL FLIP, AND RESTING THE RIFLE	411
XX THE POPE MUZZLE LOADING SYSTEM	418
XXI TARGET MEASUREMENT	428
XXII ADJUSTMENTS AND REPAIRS	432

PART II

PRACTICAL RIFLE SHOOTING

XXIII THE A. B. C. OF MARKSMANSHIP	455
XXIV AIMING	458
XXV HOLDING AND THE FIRING POSITIONS	466

CONTENTS

CHAPTER	PAGE
XXVI TRIGGER PULL	486
XXVII CALLING THE SHOT	490
XXVIII SIGHT ADJUSTMENT	492
XXIX POSITION AND AIMING DRILLS	501
XXX GALLERY SHOOTING	505
XXXI EQUIPMENT FOR OUTDOOR RANGE SHOOTING	514
XXXII ELEVATION	520
XXXIII ZERO	526
XXXIV WINDAGE AND WINDS	528
XXXV THE SCORE BOOK	536
XXXVI MILITARY RIFLE SHOOTING	543
XXXVII TEAM SHOOTING	552
XXXVIII REST SHOOTING AND TESTING	559
XXXIX RANGE PRACTICE FOR THE SPORTSMAN	574
XL SHOOTING AT MOVING OBJECTS	584
XLI THE RIFLE IN THE WILDERNESS	588
XLII THE CLEANING AND CARE OF THE RIFLE	598
XLIII RIFLE-RANGE CONSTRUCTION	614
XLIV THE NATIONAL RIFLE ASSOCIATION OF AMERICA	625
INDEX	633

PART I
HISTORICAL, INTRODUCTORY, CONSTRUCTION, AND BALLISTICS

THE AMERICAN RIFLE

CHAPTER I

THE HISTORY OF THE RIFLE IN AMERICA

THE date of the invention of the rifle is not known with any certainty. Modern rifles and ammunition are the outcome of centuries of evolution. There are extant some early German cross-bows, the missiles from which were delivered through guiding tubes having spiral slots or grooves cut upon their interior surfaces. It is usually claimed by writers on this subject that a date between 1470 and 1500 marks the introduction of rifling into the bore of shoulder arms in order to make the bullet fly true to a greater distance than was possible with the smooth bore. Gaspard Kollner of Vienna became celebrated for rifled guns as early as 1500.

The rifle was introduced into America by the Germans from the Rhine countries, and the Palatine Swiss, who began settling in Pennsylvania in 1683. Some of these settlers were artisans and gun-makers. The rifles which they first introduced were short, heavy, and had a bore of about an inch. The recoil was terrific, and they were very slow to load. The bare lead ball was driven down the bore by the blows of a mallet, and an iron ramrod. After the first shot the bore became so fouled that it often required fifteen minutes to load again. The settlers soon found that the shooting conditions in their new land were far different from those pertaining in Europe. In Europe the rifle had been used only for war, and for sport in settled communities where no particular hardship resulted from a lost or bad shot. But in America the first settlers lived in an immense wilderness, and had to depend upon their weapons for much of their food, and often for their lives. Their weapon had to be accurate, and it was very desirable, owing to the difficulties of supply, that it should not waste any of the powder charge; hence a long barrel was necessary. Ammunition sufficient for long periods often had to be carried on the person, and this led to the small-bore weapon.

THE AMERICAN RIFLE

Speed of fire was often essential, and some settler evolved the greased patch. Also, in order to make the report of the rifle as light as possible in order that it might not reach the ears of distant Indians, a heavy barrel was found very desirable. Gradually, as the gunsmiths and pioneers consulted together and experimented, these changes were brought about, and the first type of American rifle was evolved. This first American rifle reached its development about 1739. It was a flint-lock, long, slender, and very heavy. Its round lead bullet was

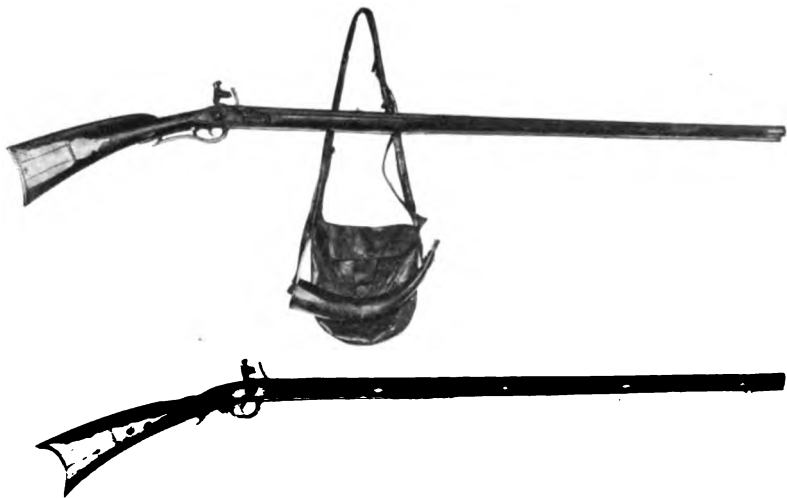

Fig. 1

Early American flint lock rifles.

Upper. One of the earliest American rifles. Made by Matthew Roesser, Lancaster, Pa., 1739. Half octagon barrel, weight 8 pounds, caliber .40.

Lower. Rifle made by James Woods about 1810. Caliber .45, weight 9 pounds. Rifle is still in perfect condition, and gives accurate targets. Used by the present owner for hunting in 1917.

from half an ounce to a full ounce in weight. On the right side of the stock of the rifle was a little brass patch box, in which there was kept a number of circular patches of greased linen or leather. The powder was kept in a powder horn, usually a steer horn hollowed out thin, and often elaborately and artistically engraved and carved. The powder was poured from this horn, sometimes into a measure, and sometimes into the palm of the hand, and the amount gauged. It was then emptied into the muzzle of the rifle, and a greased patch centered over the muzzle. A bullet was placed over this patch and shoved into the bore with the thumb, the rifle being held perpendicularly

all the while, the butt resting on the ground. Then the light hickory ramrod was drawn from the thimbles under the barrel, the concave head was placed on the bullet, and the lubricated ball slid down the bore until it rested on the powder charge. Then the ramrod was flung or "wanged" down the bore a couple of times, thus flattening the ball somewhat, and upsetting it so that it filled the bore to the bottom of the rifling, thus shutting off the escape of gas around it. The ramrod was returned to its thimbles, a few grains of powder carefully placed in the pan of the lock, and the rifle was ready to fire. A skillful rifleman could perform this operation of loading in about 30 seconds. It is told of some of the early pioneers that they were so skillful that they were able to load their rifles on a run. While the rifle is not an American invention, as many have supposed, yet it is believed that the Pennsylvania Dutch should be given the credit of first developing it into an efficient weapon for sport and war.

It is interesting to note just what these old rifles were capable of. One of these rifles made by Rosser of Lancaster, Pa., in 1739 and at present in the possession of Mr. John Dillon of Philadelphia, was tested by the Remington-U. M. C. Co. at their factory several years ago with the following results:

Rosser flint lock rifle, made in Lancaster, Pa., 1739.	Round ball, .32 inch diameter, weight 49 grains, powder charge 22 grains of black powder.
Average velocity over 53 feet.....	1,305 feet per second
Muzzle velocity	1,483 feet per second
Muzzle energy	239 ft. lbs.
Velocity at 100 yards	850 feet per second
Energy at 100 yards	79 ft. lbs.
Velocity at 200 yards	617 feet per second
Energy at 200 yards	41 ft. lbs.

These rifles were not reliable at ranges over 150 yards, and were seldom used over 100 yards. Their best range was about 60 yards, and in their time a majority of rifle matches seem to have been held at that range. At that range a good shot with a good rifle could keep all his shots inside a circle about an inch and a half in diameter. In other words, they were about as accurate as our ordinary rifles of today, up to 100 yards, but are far surpassed by our best rifles, while as to power we can best class them as being about on a par with our .25 Stevens rim-fire cartridge at short ranges.

For a long time the Pennsylvania Germans were the only rifle-makers in America. History points to Lancaster, Pennsylvania, as

being the birth-place of the rifle on these shores. The frontiersmen of Maryland, Virginia, and New York soon caught on to the superior qualities of the new weapon, and were not slow to adopt it. In 1750 it was in very general use all along the Allegheny border. In our wars we first heard of its use in the attack on the French stronghold of Louisburg, on Cape Breton Island, which was at that time the key to the French possessions in America. The Pennsylvania riflemen advanced against the fortress in trenches by sapping, and when near to the walls the precision of their rifles made it impossible

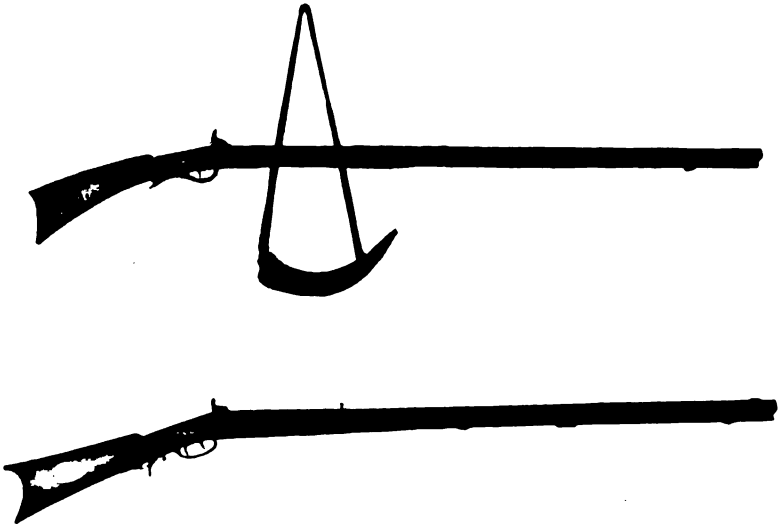

Fig. 2

Early American percussion lock rifles.

Upper. Originally a flint lock made about 1780, and later converted into a percussion lock. Forty caliber, weight 8½ pounds. Probably made in Reading, Pa.

Lower. A more modern American rifle made by James Goulcher, Philadelphia, Pa., about 1865. Caliber .43, weight 11 pounds.

for the Frenchmen to serve their cannon. The rifle was practically unknown in New England until the frontiersmen of Pennsylvania and Virginia arrived at the siege of Boston in the Revolution. The first troops levied by the Continental Congress were six companies of riflemen from Pennsylvania, two from Maryland, and two from Virginia, which joined the main army at Cambridge in August, 1776. These companies consisted of three officers and seventy-seven enlisted men each, and were recruited entirely from frontiersmen. They were armed with rifles, which each man provided himself, and were glad

in buckskin. At the very start they distinguished themselves on the march to Cambridge by covering this distance, 550 miles, in 22 days without the loss of a single man. During the Revolution, the Congress entered into contract with several riflemakers in the South to furnish a small number of these arms for our troops, but as a rule the rifles in use in the Revolution were the private property of the men carrying them. It was not until 1819 that the United States took up the manufacture of a rifle for the army. It is thought, but not known positively, that some of these rifles were made at the Springfield Armory. This model 1819 rifle was a flint lock, muzzle loader of .54 caliber, shooting a round ball, 32 to the pound, and a charge of 100 grains of black powder. Its weight was 9.203 pounds, and its length without bayonet was 51.31 inches.

Shortly after the close of the Revolution, a Scottish clergyman named Alexander J. Forsyth invented the percussion-cap system of igniting the powder charge. This noteworthy improvement took quite a while to reach our shores, and it was in fact not until 1842 that the percussion lock and cap came into general use in this country, although quite a number of privately made arms were constructed with this lock several years before this date. The English army adopted percussion ignition for their Brunswick rifle in 1835. About this time the exploration and settling of the West started, and gradually there were developed two distinctly American types of muzzle-loading, percussion-cap rifles. One of these was the well-known Kentucky rifle, an extremely long rifle of small bore. The Eastern rifleman demanded a small-bore arm in order that he might be able to carry a large supply of ammunition on his journeys, which were usually made on foot, carrying everything on the back. Thus the Kentucky rifle was sometimes known as a "pea rifle," because it fired a ball about the size of a pea, about .32 to .38 caliber. Usually these rifles when new were about .32 caliber, but as the bore became worn and rusty the owner would take it to the maker and have it rebored, and a new bullet mould made, and so the older the rifle the larger the bore. The barrel varied in length from about 36 inches to 48 inches, and was very heavy, making the total weight of the rifle from 12 to 15 pounds. It had a small stock, rifle butt-plate, and double set triggers. The forestock usually extended up to the muzzle, and contained the ramrod. The butt-plate, patch box, and trimmings were usually of brass, and often elaborately engraved.

But this rifle did not suit the Western hunter, trapper, and explorer.

The bore was not sufficiently large for effective work on the larger Western game, such as elk, buffalo, and grizzly bear. It lacked killing power and it also lacked range. Moreover, the long barrel was very unwieldy on horseback. Economy in the weight of ammunition was not such a factor, as the Westerner usually had pack ponies for his transportation. So there was gradually evolved a Western type of rifle, reaching its perfection in the rifles made by the Hawken Brothers of St. Louis just before the Civil War. These weapons were of larger caliber, from .40 to .60 inch, and in later years fired a conical instead of a round ball. The barrel was much shorter, usually about 30 inches. The stock was much heavier, to stand the rougher service, and the forearm often extended only half-way up the barrel. The other features of the Kentucky rifle were however retained.

Improvements in rifles came rapidly during the first half of the nineteenth century, practically all being directed towards a breech system of loading. In fact in 1808, only a year after the invention of the percussion cap, patent rights were granted to a French gunmaker for a paper cartridge to the base of which a paper fulminate cap was attached. The cartridge was inserted from the breech, and the firing of the charge was brought about by piercing the cap with a needle which was impelled forward by a spring. Most of the early attempts to produce a breech-loading gun, however, resulted in developing a great and grave distrust for any and all systems of loading from the breech end, and it was not until our Civil War was well under way that we witnessed the production of a really effective and safe breech loader. The first breech-loading rifle to be adopted by the army of any nation was the well-known "Needle gun," which was invented about 1839 by Dreyse, a German, and was at first intended as a sporting arm. The first model suffered badly from some of the same defects that had caused all its predecessors to be rejected, namely the escape of gas and flame at the breech end, but the Prussians became interested in it in 1842, and after many experiments and improvements adopted it in 1848. Meanwhile our own inventors had been active, and about 1855 saw the invention and development of the first Sharps breech-loading rifle. This arm had a vertically sliding breech block, somewhat like that on the present Winchester single-shot rifle. The cartridge was made of a paper cylinder, carrying the conical bullet at the forward end and the powder charge in rear. The breech block was dropped down and the cartridge inserted from the rear. When the breech block was pulled up into place again it shaved the paper off

the rear end of the cartridge, thus exposing the powder to the face of the breech block. The breech block carried a nipple and a flash hole through it. After the breech was closed, a percussion cap was placed on the nipple and the rifle was ready to fire. This Sharps rifle was issued to a few British regiments for experimental purposes in 1857, and shortly after the start of our Civil War its issue in carbine form was begun to the Union Cavalry. It also became very popular as a sporting arm, particularly in the West. The paper cartridge, however, was quickly supplanted by the brass shell, to which the Sharps and many other rifles were quickly adapted. During the Civil War repeating rifles also began to be in evidence, one of the first of these being the Spencer, which was patented in 1860. This rifle had a lever formed of the trigger guard like the Sharps, but the breech block rotated downward and back on a hinge. The magazine was in the butt stock. A number of these were used in the Civil War, and also sent into the West at the close of the war. The Spencer was quickly followed in 1866 by the Henry rifle, which is the predecessor of our present Winchester repeater. The success of the Henry rifle was very rapid, and it quickly drove most of the other rifles off the market, many of the old Spencer rifles getting into the hands of the plains Indians. One rifle to retain its popularity for a long time, however, was the old Sharps single shot, now adapted to a metallic cartridge and considerably improved. One reason for this was the powerful cartridge which it carried, all the first of the repeating rifles being made for short cartridges of small power, and not well adapted to the larger Western game or for long range. The Sharps was the rifle that killed off the buffalo; one model of the Sharps in fact being called the "buffalo gun." This was .45 or .50 caliber, with a very heavy octagon barrel, and outside hammer. The first of the Sharps rifles had outside hammers very similar to the old muzzle-loading hammer, but towards the end of its career the Sharps Rifle Company made a single-shot, hammerless rifle, the firing pin and mainspring being contained in the sliding breech-block. This excellent rifle found its way into the hands of a few Westerners, and also became a popular, long-range, target weapon. It carried probably the most powerful black-powder cartridge ever designed in America, a .45 caliber, the long, straight, brass shell containing as much as 120 grains of black powder, and the paper-patched bullet weighing 550 grains.

The Henry repeating rifle, which was so popular in those days (1870), used a .44 caliber, rim-fire cartridge, containing 28 grains

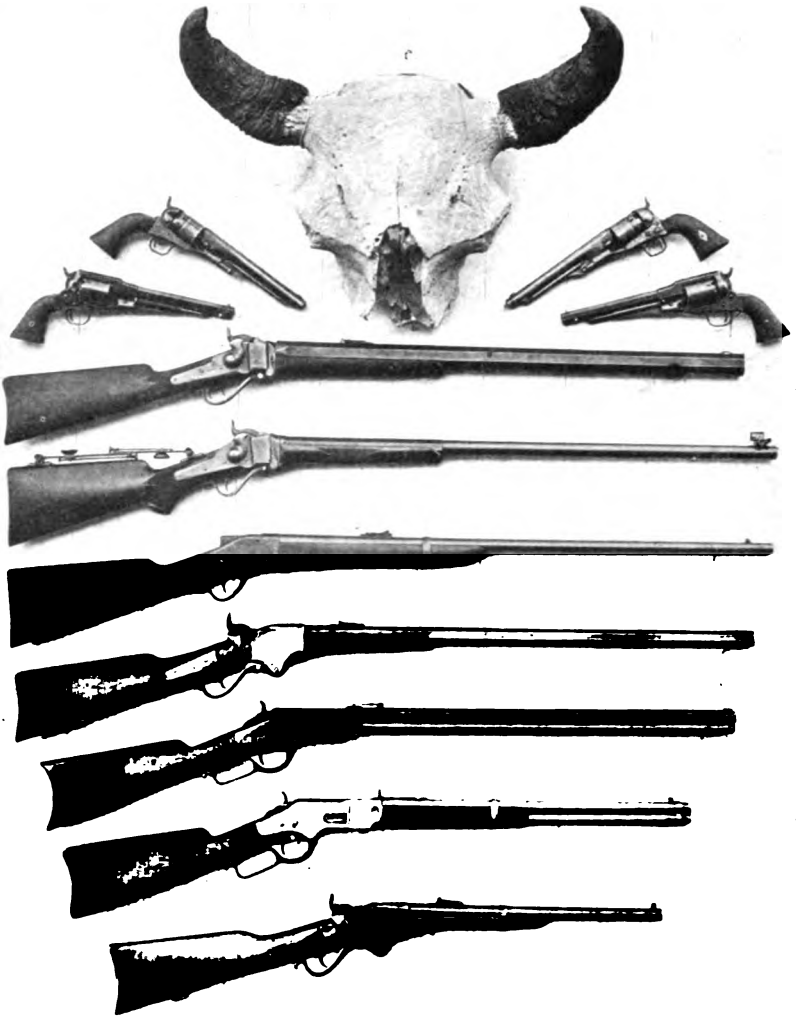

Fig. 3

Arms of our late frontier. In order from top to bottom:

1. Sharp's buffalo rifle, caliber .45-120-550. Weight 17 pounds.
2. Sharp's rifle, Creedmoor Model for long range target shooting.
3. Sharp's-Borchart hammerless rifle, semi-military model.
4. Spencer rifle, caliber .56-44 rim fire.
5. Henry repeating rifle, caliber .44 rim fire, from which the Winchester rifle was developed.
6. Winchester carbine, Model 1866, caliber .44 rim fire. The first Winchester rifle made.
7. Spencer carbine, caliber .56 rim fire.

of powder and 200 grains of lead. In 1866 the Winchester Repeating Arms Company was organized, this company purchasing the Henry Arms Company and the Spencer Rifle Company, and continuing the manufacture of the Henry rifle until quite recent times. In 1873 the Winchester Company placed on the market the Winchester Model 1873 rifle, probably the most famous rifle produced in America, and the rifle which has made the name "Winchester" famous throughout the world. This rifle was very similar to the Henry rifle, in fact it was made under the Henry patent, but it was very much better made, so much so that it was a thoroughly reliable arm. Until its advent repeaters were not considered weapons that could be relied upon under all circumstances, and many hunters, trappers, and explorers still stuck to their old single shots. But the Winchester Model 1873 practically drove all the single shots to the wall. It was first adapted to the cartridge known as the .44 W. C. F., or .44-40; a center-fire cartridge containing 40 grains of black powder, and a flat-nosed, conical bullet of 200 grains. While this cartridge was quite a little more powerful than any charge which had hitherto been adapted to a repeating rifle, it was not considered powerful enough by sportsmen for Western game, and this led to the manufacture of the Winchester Model 1876, or "Centennial Model," adapted to much more powerful cartridges, namely the .45-75-350 W. C. F.; .45-60-300 W. C. F.; and .40-60-210 W. C. F. About the same time the Model 1873 was adapted to three other cartridges; the .38-40-180; the .32-20-115, and the .22 long rim fire. The Centennial model had practically the same breech action as the Model 1873.

We must now turn to the development of the military rifle immediately following the Civil War. The first breech-loading rifle manufactured at the Springfield Armory was that known as the Model 1866. This had the famous old "Springfield" action with hinged breech-block. It used a .50-caliber, center-fire, brass cartridge, containing 70 grains of black powder and a 450-grain, grooved, lubricated, conical bullet. In 1873 this rifle was improved a little, and the caliber reduced to .45-70-405. Later the weight of the bullet was increased to 500 grains; the .405 grain bullet, however, being retained for use in the carbine of this model. In all, ten models of the single-shot Springfield rifle have been manufactured at the Springfield Armory, each being a slight improvement over its immediate predecessor. The last one was the Model 1888, containing the rod bayonet. The .45-caliber Springfield was a most reliable and effective weapon. Its

breech action could be operated so quickly that, until the advent of smokeless powder, our army saw no need of adopting a repeating rifle. With the .500-grain bullet this rifle was quite accurate up to 800 yards, but the angle of fall at 1000 yards was too great for good target work at that range. My first experience at military target shooting was with this arm, and my old score books show scores up to 48 at 500 yards and 43 at 600 yards.

Almost all important improvements and inventions in firearms have been made primarily for military purposes, and have then been adapted to sporting arms. Having developed the repeating rifle, army officers found that the rapidity of fire of which these rifles were capable could not be fully used on the battlefield owing to the great cloud of smoke which soon arose, obscuring the hostile target. Hence there came a demand for a powder which would burn without so much smoke. Another reason for desiring such a powder was that with black powder a force at once disclosed its exact location as soon as it opened fire. The development of smokeless powder, like the development of the rifle, is more in the nature of a gradual evolution and improvement than the invention of a single man. Serious experiment with smokeless powders dates from 1846, when Schonbein reported that he had discovered a cotton powder which he thought might be used for guns, which would burn without smoke and which left very little residue behind it. A year later Dr. Hartig discovered that it was possible to dissolve guncotton in acetic ether, and it would then, without altering its chemical state, become a clear stiff jelly when the excess of ether had evaporated. If the ether was allowed to evaporate slowly and entirely, a white residue remained behind which had the same property as the original guncotton, but exploded much more slowly than guncotton. Here, then, we have the first indication that the rate of combustion of guncotton could be controlled. In 1864, Captain Schultz, a German, invented a smokeless powder, which was originally made from disks of wood, boiled in soda and steamed for many hours, and then nitrated. This was the original Schultz shotgun powder, which, in an improved form, is still on the market, but is not suitable for use in rifles. The first man to make a smokeless nitro powder suitable for use in rifles was Frederick Volkmann, who patented a powder in 1871 which he called "Collodin," which would stand immersion in water, and with which the speed of combustion could be controlled by the degree to which the solution of the grains in ether alcohol was allowed to proceed. About this time it became apparent also that a flat tra-

jectory was very desirable from a military point of view, and that this could be obtained only from a very small bore, long bullet, and large charge of powder. The initiative in this respect came from Switzerland. Major Rubin of the Swiss Ordnance Department in 1883 invented the rifle which bears his name and also designed the cartridge adapted to it. This cartridge had a bullet measuring only .295 inch, and a very large charge of powder. In the meantime a British committee had been appointed to select a new rifle for the army. They went very carefully into the matter and adopted a cartridge of .303 caliber, having a bullet with a cupro-nickel jacket and a lead core. The powder charge was a compressed cylinder of black powder weighing 70 grains. The velocity of the cartridge was a little over 1800 feet per second, or about 400 feet more than it had been possible to obtain from the large caliber rifles. The cartridge was not a success as the development was really in advance of the black powder used. However, even before it could be condemned a remedy was found in the new smokeless powder. The black powder in this small bore gave so much fouling that accuracy was practically impossible, but the smokeless powder gave almost no fouling and permitted the velocity to be increased to a little over 2000 feet per second. All the other European nations quickly saw the advantage of this new arm and were not slow to change their armament. The United States was among the last to do so. In 1892 the Ordnance Department adopted a foreign rifle, the Krag-Jorgensen, for the regular army, and the manufacture of it was commenced at the Springfield Armory. It used a cartridge having a bullet measuring .308 inch and weighing 220 grains. The bullet was jacketed with cupro-nickel, and had a lead core. The powder charge was about 40 grains of a smokeless powder, giving a velocity of about 2000 feet per second. The issue of this rifle was restricted entirely to the regular army. In 1898 a number of minor improvements were made, and the Krag-Jorgensen rifles seen at the present day are almost all of them what is officially called the United States magazine rifle, Model 1898.

The first high-power sporting rifle to be placed on the American market was the Winchester single-shot rifle, adapted to the .30-40 U. S. cartridge (the cartridge used in the Model 1898 rifle). It appeared on the market in April, 1894. In March, 1896, the Winchester repeating rifle, Model 1895, also handling this cartridge, was advertised for sale, and we now pass from the realm of history into the consideration of modern American rifles.

In this little sketch of the development of the rifle in America I have been forced to omit reference to many excellent and celebrated arms which have now passed into history, such for instance as the Ballard, the flying-lock Remington, and many others. To refer to and describe them all would require a whole volume, and I have there-



Fig. 4

Ballard rifle, a favorite of twenty years ago, and still preferred by Schuetzen riflemen for 200-yard target shooting

fore preferred to give only a short and truthful sketch which would show briefly the part that the United States has had in the development of the rifle.

CHAPTER II

THE A B C OF RIFLE BALLISTICS

A RIFLE is a gun intended to be carried by one man and fired from the shoulder. It differs from the shotgun or smooth bore in that the surface of the bore is cut with a number of *grooves*. These grooves are given a spiral direction in the bore, and this has the effect of rotating a bullet forced through the bore by the explosion or expansion of the powder gases. This rotation of the bullet continues after it has left the barrel, the bullet revolving on its longer axis as it travels through the air. Thus the bullet, during its flight, goes to sleep like a well-spun, boy's top, and this causes it to fly accurately, and point to the front, for a much longer distance than would be the case were it shot from a smooth-bore gun.

The bore of American rifles varies in diameter from .22-inch to .50-inch, and in designating the size of the bore of a certain rifle its diameter is usually given in hundredths or thousandths of an inch, and this measurement is called *caliber*. Thus we have a .22-caliber rifle, a .30-caliber rifle, a .405-caliber rifle, and a .50-caliber rifle, and so on. It is usual to designate as the caliber of a certain rifle the diameter of the smooth bore through the barrel before it is cut with the grooves or rifling. The grooves of a rifle vary from .002-inch to .006-inch in depth, and are usually from four to eight in number. The raised portion of the original surface of the bore between the grooves is called the *lands*. Thus a .30-caliber rifle is first bored out to a smooth, even bore, .30-inch in diameter. The barrel is then placed in a rifling machine and the grooves are cut in it. In the .30 caliber these grooves are usually .004-inch deep, so that this makes the inside diameter of the barrel from the bottom of one groove to the bottom of the opposite groove .308-inch. In England the diameter of the rifle's bore is usually given in thousandths of an inch instead of hundredths, thus what we would call a .45-caliber rifle they would term a .450-bore rifle. On the continent of Europe still another nomenclature is in use; that is, the diameter in millimeters instead of

inches, and thus we have foreign rifles of 6.5 mm., 7 mm., 7.65 mm., 8 mm., 9 mm., 9.3 mm., 10 mm., and so on.

The number of grooves in the bore of a rifle varies between four and eight. The twist of the rifling throughout the barrel varies between one complete turn and $6\frac{1}{2}$ inches of the barrel's length, and one turn in 60 inches. The longer the bullet in proportion to its diameter, and the slower the velocity with which it travels, the quicker must be the twist to spin the bullet so as to keep it point to the front, or to maintain its *gyrostatic stability*.

The breech end of the bore is enlarged and shaped so as to form a *chamber* in which the cartridge fits when the rifle is loaded and ready to fire.

The breech is sealed or blocked to the rear by the *breech block* or *bolt*, which supports the head of the cartridge, and sustains the force of the explosion. The block or bolt is pierced in the center to contain the *firing pin*. The firing pin, pulled back, compresses the *mainspring*, and is held in this position by means of the *sear*. When the sear is depressed by the pulling of the *trigger*, the firing pin is released, and carried forward by the mainspring, and its end juts out through the hole in the face of the block or bolt, striking the primer a blow, indenting it, and firing the cartridge.

The cartridge consists of *bullet*, *shell* or *case*, *powder*, and *primer*. The bullet is conical in shape (spherical bullets are now obsolete) and is made of either a lead and tin alloy, or of a lead and tin alloy with a jacket of cupro-nickel or copper. Its diameter is the same as the groove diameter of the bore, or very slightly smaller. The bullet is seated in the forward portion or *neck* of the shell. The shell is made of brass, and contains the powder. On the center of its base is a *primer pocket*, in which is seated the primer. The primer is a brass or copper cap, containing the fulminate and an anvil. When the firing pin strikes the primer, the fulminate is compressed or crushed between the cap and anvil. This causes a spark or flash to pass through the flash hole in the primer pocket into the interior of the shell where the powder is contained. The powder is ignited, and burning, produces a quick, powerful, and elastic gas, which forces the bullet ahead of it and out through the bore. Rifles vary in the velocity with which the bullet leaves the muzzle (*muzzle velocity* or *initial velocity*, abbreviated M. V.) from 900 to 3400 feet per second.

If the bullet, after leaving the muzzle, were subjected to no other forces than the explosion of the powder, it would continue to move

forward with unchanged velocity in prolongation of the axis of the bore, passing over equal spaces in equal times. But the air displaced by the bullet offers a resistance which reduces the velocity of the bullet, causing the space over which it passes in equal times continually to diminish. Thus if, neglecting the resistance of the air, a bullet would reach at the end of one second a point A, this resistance would cause it to reach only some point A', and at the end of two, three, and four seconds, only to reach points B', C', and D', instead of B, C, and D. (See Fig. 5.) The diminished velocity at any point is called the *remaining velocity* at that point, and is measured by the space in feet which the bullet would pass over in the next second if the velocity suffered no change.

On leaving the muzzle the bullet is also subjected to the force of

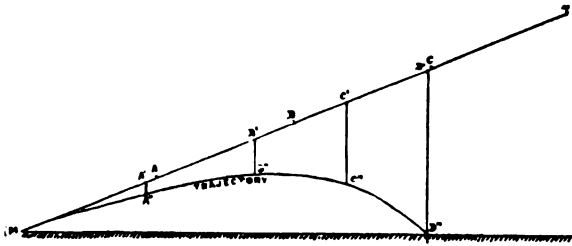

Fig. 5

gravity, which causes it to fall about 16 feet in the first second of flight, 48 feet in the second, or 64 feet in two seconds, 80 feet in the third, of 144 feet in three seconds, etc.; the fall in any second being about 32 feet more than in the next preceding. The fall due to gravity is not influenced by the velocity of the bullet, being the same as if the bullet were dropped from a state of rest. Thus the bullet, at the end of one second, instead of being at A', will be at A'', 16 feet below A'. At the end of two seconds it will be at B'', at the end of three seconds at C'', etc. The resistance of the air reduces the velocity of the bullet's fall, but this effect is not important at moderate ranges.

The curved path followed by the bullet in its flight through the air under the combined action of these forces is called its "*trajectory*," and is represented by the curved line in Fig. 5. When we speak of the trajectory of the bullet we mean its path through the air from the muzzle of the rifle to the point where it hits the target.

In order to be prepared to discuss and compare the trajectories of various rifles, the reader should be familiar with certain terms used

in conjunction with the trajectory. Thus, the *angle of departure* is that between the ground and the tangent to the trajectory where it leaves the muzzle of the rifle. The *line of sight* is a straight line passing from the pupil of the markman's eye through the rear and front sights, to the point on the target where the rifle is aimed. The *angle of elevation* is that between the line of sight and the tangent to the trajectory where it leaves the muzzle of the rifle. The *ordinate* of any point in the trajectory is its vertical distance above the line of sight. In giving ordinates it is customary to give them for every 100 yards of range, measured on the line of sight. The trajectory reaches its greatest height, or highest ordinate, in one-half the time of flight; hence, since the velocity continually decreases, this is more than one-half the range distant from the muzzle of the rifle. The *range* is the distance, measured on the line of sight, from the muzzle of the rifle to the target. The *angle of fall* is that between the ground and the tangent to the trajectory where it meets the ground.

The point where the bullet strikes the target is called the *point of impact*. A number of shots striking a target are called a *group*. The center of the group is called the *center of impact*. If a rifle be fired for a series of shots with a constant point of aim and a constant sight adjustment, the diameter of the circle which will include all of the shots gives the *measure of accuracy* of that rifle and ammunition. An accurate rifle and ammunition produce a small group. A rifle is said to be accurate when, at a given range, its dispersion does not exceed three minutes of angle; that is, when the circle which will include all the shots has not a greater diameter than 3 inches at 100 yards, 6 inches at 200 yards, 9 inches at 300 yards, 15 inches at 500 yards, 30 inches at 1000 yards, etc.

The *energy* of a bullet is its ability to perform work, that is its ability to strike a blow, or to overcome the resistance of the air. It is measured in foot pounds, and decreases as the range increases and the velocity diminishes. Thus we have *muzzle energy* and *remaining energy*. The energy increases with the weight of the bullet and with its velocity. The amount of energy remaining at any range not only depends primarily upon these features, but also on the ability of the bullet to maintain its velocity, that is to overcome the resistance of the air. A long, heavy bullet (i.e., one with great sectional density) maintains its velocity better than a short, light one. A bullet with a long, fine point maintains velocity better than a blunt-pointed bullet.

The *recoil* or *kick* is the movement of the rifle to the rear at the

instant it is fired. It depends upon the weight of the rifle, the weight of the bullet, the initial velocity, the caliber of the rifle, and the rapidity of burning of the powder. The ability of the shoulder to stand recoil limits the power and caliber of the rifle to be fired from the shoulder.

CHAPTER III

THE NOMENCLATURE AND CLASSIFICATION OF AMERICAN RIFLES

THE American nomenclature and classification of rifles and rifle appurtenances is rather confusing to one not acquainted with the same. At the same time a knowledge of it is very essential to the understanding of the subject as set forth in this and other works on the American rifle. The system is the more difficult because there is no system to it. It is the outcome of the trade language as set forth in the catalogues of five or six of our leading rifle and cartridge manufacturers, together with a number of names and classifications, partly slang, which have come into general use among the riflemen of America.

American rifles are divided into a number of classes. As regards caliber we have *small-bore* rifles, and *large bores* or calibers, the dividing line being placed usually at .35 caliber, that rifle being included among the small bores. As regards power, we have *high-power* and *low-power* rifles, also called high velocity and low velocity. The dividing line being placed at 1750 feet per second velocity, all rifles having velocities over that figure being in the high-power class. Of late there has been a tendency to call rifles having a velocity of over 2400 f. s. "*high intensity*" rifles, to distinguish them from those whose velocity runs around the 2000 f. s. mark.

As regards their action or mechanism, we have a large number of names and classifications. *Single-shot* rifles are those firing but a single shot at a time, and having no magazine or container for cartridges other than the one in the chamber. *Repeating* rifles, strictly speaking, are those having a tubular magazine under the barrel, containing a number of cartridges, the operation of the breech mechanism ejecting the fired shell and loading a fresh cartridge. *Magazine* rifles are those in which the magazine containing the reserve of cartridges is located under the bolt or breech-lock. *Lever-action* rifles are those repeaters and single shots which are actuated by means of a lever under the grip, usually an extension of the trigger guard. *Bolt-action*

rifles are those that are actuated by a bolt, somewhat like a door bolt, the bolt handle being pulled up and backward to throw out the empty shell, and then pushed forward and down to load the fresh cartridge and lock the rifle. The older types of lever-action rifles are almost all repeaters, but we have also several lever actions with the magazine under the breech-block. Bolt-action rifles are usually military arms, or military actions converted and remodelled for sporting use. Auto-loading rifles are those in which the recoil is utilized to reload the rifle; the trigger, however, requiring to be pulled each time to fire a shot. An automatic rifle is one in which the recoil loads and fires the rifle, the rifle continuing to load and fire as long as the trigger is held back. There are no automatic shoulder rifles made, all rifles of this type requiring a tripod or other rest, and are intended entirely for military purposes, their weight precluding their being used as shoulder arms.

The principal manufacturers of rifles in this country at present, in addition to the Ordnance Department of the United States Army, and certain firms manufacturing government arms under contract, are:

The Winchester Repeating Arms Company.

The Remington Arms-Union Metallic Cartridge Company.

The Savage Arms Corporation.

The Newton Arms Company.

An examination of the catalogues of these companies will give one a very clear idea of the names and classification of the various modern American rifles.

When it comes to cartridges, the nomenclature is also rather confusing. Upon the introduction of the breech-loading cartridge the usual method of naming and distinguishing between the various cartridges was to give three figures, the first being the caliber, the second the number of grains of black powder contained in the shell, and the third the weight in grains of the bullet. Thus we have the .32-40-165, being a cartridge of .32 caliber, containing 40 grains of black powder, and a bullet weighing 165 grains. Sometimes the name of the maker of the rifle using the cartridge was coupled with the cartridge, thus we have the .40-70-330 Winchester. In some cartridges the fulminate is contained in the rim of the shell instead of in a primer. These are usually small cartridges, and are called "rim fire," the cartridges containing the regular primer being called "center fire." We find a large number of cartridges called "W. R. F." and "W. C. F.," meaning Winchester Rim Fire, and Winchester Center Fire. Among these

are the .22 W. R. F., the .44 W. C. F., the .33 W. C. F., the .25 Stevens Rim Fire, etc. The United States Government cartridges represent again another system of nomenclature, those for the Model 1898 rifle being called ".30 cal. Model 1898 Ball Cartridge." This same cartridge, by the way, is called ".30 U. S." in the Winchester catalogue, and is popularly called the .30-40-220. The cartridge for the U. S. Magazine Rifle, caliber .30, Model 1903, the present service arm of the United States, is officially called the "Ball Cartridge, caliber .30, Model 1906."¹

In recent years the tendency has been to give the caliber of the cartridge in thousandths of an inch instead of in hundredths of an inch. Thus we have the .405 W. C. F., the .303 Savage, and the .351 Winchester Self-Loading. Also lately we note the appearance of two cartridges which fail to follow previous rules, namely the ".22 Savage Hi-power," and the .250-3000 Savage, the latter being a .25-caliber rifle having a velocity of 3000 feet per second.

Cartridges are still further distinguished by the names "soft point" and "full jacketed," the former being those whose bullets are jacketed around the base and side only, the lead core at the point being exposed to cause them to mushroom and expand on game and thus give a more fatal wound. The full jacketed bullet is completely covered with the jacket except a small portion in the center of the base where the lead core was inserted in the jacket, and such bullets are intended for military and target shooting and not for game shooting. Most cartridges are made with both soft point and full-jacketed bullets, and in purchasing them one should indicate which variety he desires. The soft point should always be specified for game shooting, except that sometimes riflemen prefer to carry full-jacketed bullets in addition to the soft point, the former being used on medium-sized game where as destructive a bullet as the soft point is not desired, as for example where one wishes as little mutilation of the skin as possible on account of future mounting of the specimen.

¹ The present service arm was designed in 1903, and adopted to the Model 1903 cartridge having a 220-grain, blunt-nose bullet. In 1906 all these rifles were altered to use a new cartridge with 150-grain, pointed bullet, the new cartridge being called the Model 1906. The Model 1903 cartridge then became obsolete, but the rifle retained the date of its design.

CHAPTER IV

THE AMERICAN RIFLES

THE American breech-loading rifle dates from the Civil War. An enormous number of various models have been produced since that time. At one time or another American factories have made rifles for almost all the nations of South America, southern Europe, and Asia, as well as supplied the trade, both military and sporting, in this country. Of recent years the change to smokeless powder has made a majority of these weapons obsolete, and many new arms have taken their place. The rifles described here are those at present being manufactured, both by our government arsenals and private manufacturers. Some few rifles have also been described, the manufacture of which stopped at the start of the great war, owing to the factories which made them being turned over entirely to the manufacture of munitions; but these arms are still being used in large quantities and thus a description of them seems desirable. These include mostly the products of the Stevens and Marlin companies.

Under the head of each arm I have given something of its history, its use, its operation, and rules for dismounting its action. I have also included in most cases an opinion as to its worth. This opinion is mine alone, and is simply based on my experience, together with the published experience of other riflemen, I having read and tabulated practically every bit of literature published on the rifle in this country for the past twenty-five years. I have tried to treat each rifle fairly. In the ten years that I spent experimenting and gathering data for this work I have owned, fired, and tested almost every rifle listed and for the majority of them I have only praise. While our arms are almost without exception made by machinery in large quantities, and sometimes at great speed, yet they compare very favorably with the hand-made foreign product, in many cases actually excelling them in all essentials.

This chapter may be said to deal essentially with rifle actions, the other parts being more fully described in subsequent chapters. Reliability in the functioning of the action is an absolute requirement in

a rifle. If it be a magazine arm, it must surely extract and eject the fired shell, load and lock the loaded cartridge, and surely fire it. It must do this in all weather, and in all positions. Also it must be safe. As regards the latter requirement, it may be said that every American rifle has an ample margin of safety for the cartridges it is designed to handle. If one adapts a certain rifle to a cartridge other than that for which it was designed it behoves him to know what he is about, and the same may be said when one attempts to improve the ballistics by loading the cartridges with a different charge from the standard.

The Mauser action is the most reliable form of breech mechanism that has ever been designed for repeating rifles, and it is doubtful if it will ever be improved much. The United States rifles, models of 1903 and 1917, the Savage high-power, bolt-action rifle, and the Newton rifle all have Mauser actions, some slightly modified, but still retaining all the essentials. The Mauser action is operated by means of a bolt. The mechanical design is such that this action has more power to insert and positively extract shells than any other. A force of 25 pounds exerted on the bolt handle of the U. S. Model 1903 rifle to turn it up or down results in a pull or pressure being exerted on the cartridge of 186.4 pounds, friction being considered. If friction is neglected, the pressure on the head of the cartridge exerted by a 25-pound pressure on the bolt handle is 216 pounds. This will surely insert or extract a shell slightly larger than normal, or will take care of dirt, mud, sand, rusty chamber, etc. Also this action can be entirely and easily dismantled without tools for cleaning, and this is a great advantage with a rifle which is to be subjected to hard usage in the field, and particularly with one which is to be used in the tropics or the arctic regions. With proper ammunition there is absolutely no chance of this action jamming or failing as long as the user takes pains fully to operate the mechanism — that is, always to open and pull the bolt clear back, and then fully close it without false motion.

The other rifle actions made in the United States, while they have not the absolute reliability of the Mauser action, may be regarded as perfectly reliable for all practical purposes, as the chance for any trouble is so remote that we can afford to take the chance if we prefer any other type of action to the Mauser.

As regards speed of fire, the bolt action may be regarded as the slowest of all repeating or magazine rifles. Next would come the lever actions, followed by the sliding, forearm actions, and the automatics; the latter being, of course, the fastest operated actions. Yet

the bolt action can be operated plenty fast enough for any practical use, or for aimed fire. With a rifle which recoils to any extent it takes time to recover from the shock and the unbalancing of the body before one can aim steadily and accurately again, and during this recovery there is plenty of time to operate the bolt action or any other of our American repeating actions.

A bolt action has features which are objected to by certain sportsmen. It is very difficult for a left-handed shooter to operate it with any speed. The usual safety on the cocking piece at the rear of the bolt makes this action rather slow in getting off the first shot when the rifle is locked, although this objection is fully met in the new Savage high-power, bolt action with its shotgun type of safety. The other actions — lever, trombone, and automatic — have several faults to which attention must be called. The majority of them require tools to dismount, and the operation takes considerable time. Hence they are not so liable to be kept in perfect working order inside as the bolt actions, and if anything happens it is harder to get at the trouble. All of them have a certain spring in the breech mechanism, owing to the materials of which they are made and the design of breech support. This spring is very evident when we come to use them with modern cartridges giving breech pressures of 45,000 pounds per square inch and over. The fired shell is expanded and lengthened so much that it cannot be reloaded. As a result of this spring, after a long period of use, say after the firing of 7000 to 10,000 rounds, and in some cases after a much shorter period of use, there comes a permanent springing back of the breech-bolt. The breech of the rifle does not close up as tight as it should, and the head space between the face of the bolt and the head of the cartridge is sometimes increased to such an extent that the heads are blown off the shells, and gas escapes to the rear. In other words, the action is completely worn out. Riflemen are cautioned that this trouble will probably occur only with rifles using very heavy charges, and after long years of use. Such actions, as a rule, should not be relied upon to wear out more than one barrel, whereas the bolt actions, if properly cared for, are almost everlasting. I have one which has worn out six .30-40 barrels and is still in perfect condition.

And yet, despite the faults that I have called attention to, the ordinary sportsman and hunter will have precious little fault to find with our lever action rifles. They will go on year after year giving him splendid service without a single hitch. And there is much in

their hang, feel, method of operation, and make up which appeals to the American. There is no bolt handle sticking out to one side and often in the way. There are no open parts to collect dirt and pine needles. The hammer shows at all times whether the rifle is ready or safe, and the hammer can be brought to full cock as the rifle is tossed to the shoulder without loss of time. When the rifle is grasped with the right hand in the firing position the hammer, lever, trigger, and grip seem to be in just the right position, and in the correct relation to each other, for the most efficient control and operation.

For all ordinary uses every one of our rifles are perfectly safe and reliable. In fact they have such a margin in these respects that one might almost say they were fool proof. However, when it comes to special or extremely hard use, using heavy modern charges, using the rifle for hard service in unexplored regions, the tropics, or the arctic, the Mauser type of action demonstrates its superiority.

WINCHESTER REPEATING RIFLE, MODEL 1873

This was the first repeating rifle ever made to use center-fire cartridges, and the first really reliable repeater. The action is practically the same as the old Henry repeater which used a .44-caliber, rim-fire cartridge, and which was placed on the market by the Henry Arms Company in 1866, and afterwards made by the Winchester Company. The 1873 rifle gained an enormous popularity which did not begin to wane until the introduction of the Winchester Model 1892 rifle, a superior action to handle the same cartridges. Until a few years ago practically 70 per cent. of the game killed in the United States fell to this rifle. In the West the Model 1876 or Centennial Model Winchester, exactly similar to the 1873 but to handle heavier cartridges such as the .45-75-350 with bottle-necked shell, was very popular until the introduction of the Model 1866 rifle.

The Model 1873 rifle is made for the .44 W. C. F., .38 W. C. F. and .32-20 W. C. F. cartridges, and used to be made also for the .22 short and long cartridges. It is still on the market, being probably the oldest model rifle still being manufactured. Cartridges were transferred from the tubular magazine to a position in front of the breech-bolt by means of a carrier block. The action had but one fault. The carrier block was just exactly long enough to receive the standard cartridge, and if a cartridge happened to be a little longer or shorter than standard it jammed the rifle.

The Model 1873 rifle must now be regarded as obsolete, but mention

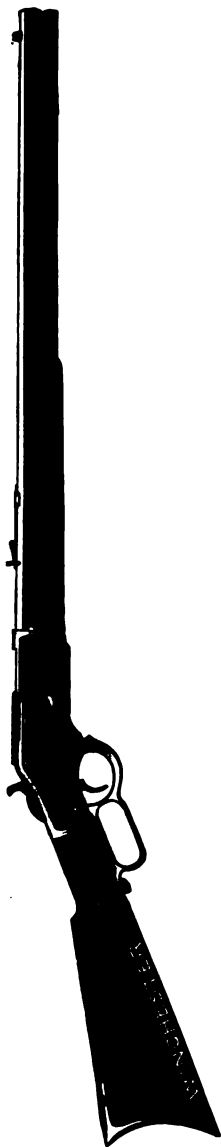

Winchester repeating rifle, Model of 1873.

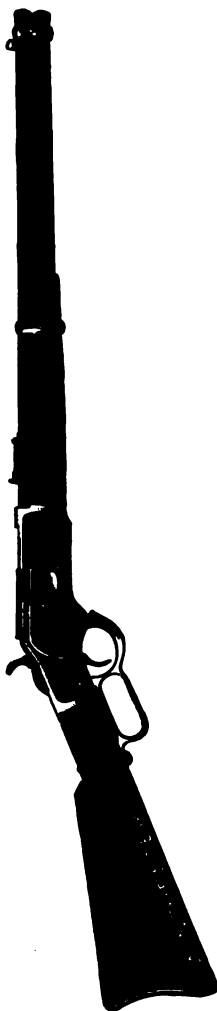

Winchester repeating carbine, Model of 1873

is made of it here because of its one-time practically universal use in America. The sectional cuts herewith explain its operation and method of taking the action apart and assembling.

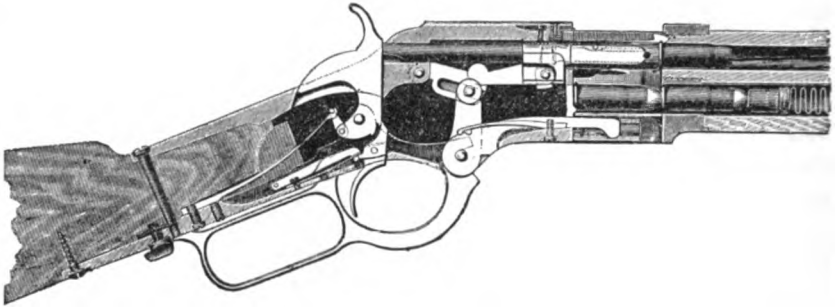

Action closed

To load the magazine. The magazine is loaded while the action is closed, as shown in Fig. 1, by pressing down the spring cover on the right hand side of the receiver with the point of the cartridge, and inserting the cartridge through the opening thus made. The opening is closed by the spring cover as soon as the cartridge is inserted. This operation is repeated until the magazine is filled.



Action open

To prepare to shoot. When it is desired to load, the finger lever B is thrown forward to the position shown in Fig. 2, and then returned to the position shown in Fig. 1. This motion throws out the shell or cartridge in the chamber, transfers a cartridge from the magazine to the chamber, cocks the hammer, and leaves the gun ready to fire when the trigger is pulled. The operation of loading is easily executed while the gun is at the hip, or at the shoulder, without taking the eye off the

sights, thus enabling the shooter to fire as many shots as there are cartridges in the magazine without removing the gun from the shoulder, or losing sight of the object shot at.

To take out the barrel. Take out the two tipscrews and the magazine ring pin; pull out the magazine tube and take off the forearm; then, before unscrewing the barrel from the frame, the breech pin must be thrown back by moving the finger lever forward — otherwise, the attempt to unscrew it will break the extractor which withdraws the cartridge and ruin the breech pin.

To remove the breech pin. Model 1873. After removing the side plates and links, take out the link pin and retractor; the firing-pin can then be pulled out with the fingers, first removing the hammer, or setting it at full cock.

WINCHESTER REPEATING RIFLE, MODEL OF 1886

This is a tubular-magazine, lever-action, repeating rifle. It was first adapted to the .45-70 U. S. Government cartridge, and shortly afterwards was also made in the following calibers, all for black-powder cartridges: .38-56-255; .38-70-255; .40-65-260; .40-70-330; .40-82-260; and .45-90. In the fall of 1900 it was also put out with nickel steel barrel for the .33 Winchester center fire cartridge, a high-power cartridge with jacketed bullet. The only black-powder cartridges that it is now made for are the .45-70 and the .45-90.

Only a very short movement of the finger lever is required to load this rifle, making it very easy to fire the gun rapidly while at the shoulder. In fact, this rifle, and the Winchester Model 1892, which has practically the same action, are the easiest and quickest in their operation of all lever action rifles. The rifle is locked by two bolts, each fitting into a slot in the receiver on one side, and into a similar slot in the breech-bolt on the other. The first opening movement of the lever draws back and locks the firing pin until the rifle is again ready for firing. A hook attached to the finger lever draws the cartridge out of the magazine into the carrier block, which enables the use of a light magazine, permitting the magazine to be filled easily. The cartridge is forced from the carrier into the chamber by the forward movement of the breech bolt. The magazine is filled while the rifle is closed, through the spring cover on the right side of the receiver, and is provided with a stop which permits the use of cartridges of different length, having the same length of shell. Thus rifles chambered for the .45-70 cartridge will handle that cartridge with either the 300, 330, 350, 405, or 500 grain bullets.

THE AMERICAN RIFLE



Fancy sporting rifle, Model 1886

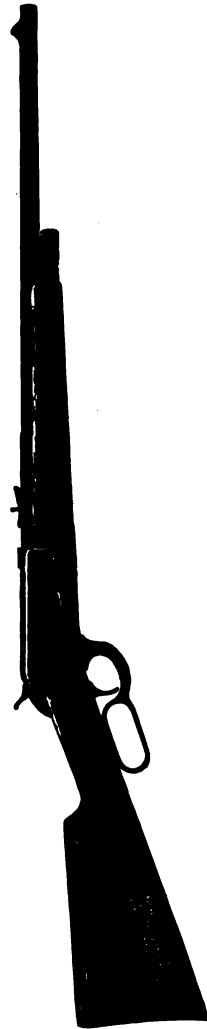

Extra light weight "take down" rifle, Model 1886

The .45 caliber rifles in ordinary weight have 26-inch barrels; the .33 W. C. F. rifle has a 24-inch barrel; while the .45-70 light-weight rifle has a 22-inch barrel. Rifles can be furnished with either straight or pistol grip stocks, and with either rifle or shot-gun butt plates, also

with either full- or half-length magazines. A full-length magazine holds 7 to 9 cartridges, depending upon the length of cartridge and magazine; and the short magazine holds four cartridges of all lengths. The operation of the rifle will readily be understood from the sectional cuts of the action.



Action closed

To dismount the gun. Remove the stock. Unscrew strain screw. Drive out the mainspring from left to right. Remove the carrier spring. Take out the hammer screw and tang with sear attached. Draw out the hammer. Remove the spring cover. Drive out the fin-



Action open

ger lever pin and bushing. Draw the locking-bolts out from below. Pull back the breech-bolt until the lever connecting pin shows at the rear of the receiver. Drive out the pin. Draw out finger lever and

carrier attached by the carrier hook. Remove the cartridge guide and magazine stop.

To assemble the gun. Put in the magazine stop and cartridge guide. Connect carrier and finger lever with the carrier hook, and put them into the receiver from below. Enter the breech-bolt at the rear, and press the upper end of the finger lever into its place in the breech-bolt. Push in the lever connecting pin. To do this it will be necessary to press back the ejector until the notch in the ejector corresponds with the pin. Push the bolt forward into the gun. Push up the locking-bolts from below. See that the cartridge guide enters its notch in the right hand locking-bolt. Replace finger lever pin and bushing. Replace the spring cover. Lay the hammer in place, and push in the tang, drawing back the trigger, so that its point may not catch on the hammer. Push in the hammer screw. Replace the carrier spring. Replace the mainspring and stock.

The Winchester Model 1886 rifle has for thirty years been easily the most popular big game rifle made in America. It has probably given more genuine satisfaction to its owners than any other rifle ever made. And this popularity has persisted in spite of the fact that it is made only for three almost obsolete cartridges. Riflemen seem willing to put up with these cartridges just to get the splendid action. The action combines, in a peculiarly lucky manner, a number of very excellent and important features. It has the best trigger pull of any repeating or magazine rifle, and while the factory pull is rather heavy it is capable of excellent refinement in the hands of a skilled gun-maker. The peculiar hang of the trigger and hammer is just exactly right for the hands of most men. The action works remarkably easy, and jams are almost unknown. The grip fits the hand very well. The action closes up tight so that snow, water, and dust do not readily find their way into the mechanism. It carries easily either in the hand or on the shoulder, and there is nothing to rattle about the rifle when stalking wary game. It is doubtful if this action will ever be equalled in a lever-action rifle. A majority of riflemen consider that the Winchester Company made a grave mistake in not adapting it to the .38-55, .32-40, .25-35, and .30-30 cartridges instead of bringing out an entirely new action, the Model 1894. The only criticism that can be made in regard to this rifle is that it is quite difficult to dismount should the mechanism require it for cleaning purposes. Personally I believe it would be well to adapt it to two more modern cartridges, one a .32 caliber carrying a 220-grain bullet at 2,300 feet per

second, and the other a .38 caliber carrying a 275-grain bullet at 2,000 feet per second. These velocities could easily be secured with the new Du Pont improved military rifle powder No. 16.

The rifle balances best with round barrel and half magazine. A very popular specification for this model is: .33 caliber; 24-inch round barrel without rear sight slot, half magazine, solid frame, pistol-grip stock, shotgun butt-plate of checked steel, Lyman ivory bead front sight, and Lyman No. 103 rear peep sight, which can be made to order for this rifle. While this rifle will not have the long range accuracy and great killing power of some of the models carrying more modern cartridges, it will probably give more satisfaction to its owner than any other big game rifle he has ever owned. It might also be said that this is probably the very best rifle for a left-handed shooter.

WINCHESTER REPEATING RIFLES, MODELS 1890 AND 1906

The actions of these two rifles are practically identical, and they both handle the .22-caliber, rim-fire ammunition. Practically the only difference is that the Model 1906 is slightly smaller and lighter, and is chambered to use interchangeably the .22-short, .22-long, and .22-long rifle cartridges, while the Model 1890 is chambered and rifled for either the .22-short, .22-long, or .22-W. R. F. cartridges, but one rifle will only handle the cartridge for which it is chambered.

The rifle has a sliding forearm action, the action being opened by pulling the forearm to the rear, and closed by forcing it to the front into place. The breech-block locks itself in plain view, and is of such size as to permit the use of a strong firing pin and extractor, and also to offer a good cover for the head of the cartridge. The action locks with each closing movement, and cannot be opened except by letting down the hammer or pushing forward the firing pin. The mechanism is such as to prevent the pulling of the trigger until the breech-block is closed and the rifle locked.

To charge the magazine. Turn the milled head at the top of the magazine until the magazine tube is unlocked. Draw out the inner tube. This will leave the loading hole open. Cartridges can then be dropped into the magazine until the same is full. After the magazine is full, press down the inner case, and when clear down turn to the left to lock it in place. If it is desired to empty the magazine without passing the cartridges through the action, draw the inner tube out entirely, and the cartridges will drop out of the mouth of the magazine.

To load the rifle. When the hammer is down, the motion of the

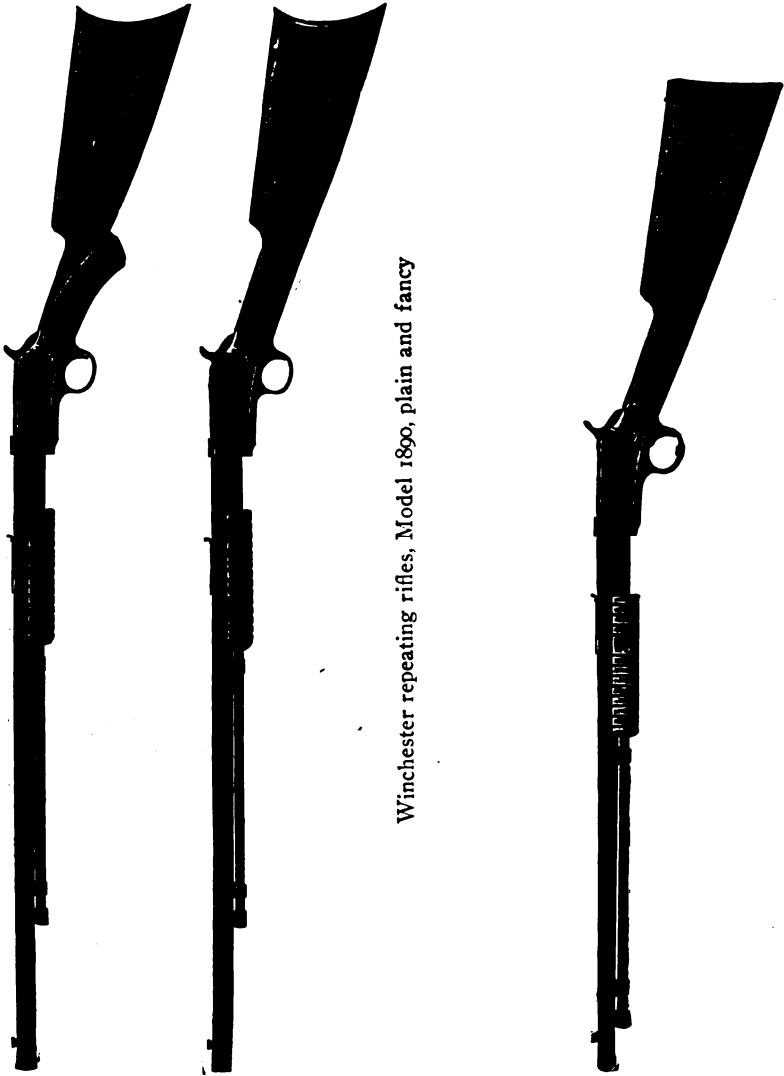

Winchester repeating rifles, Model 1890, plain and fancy

Winchester repeating rifle, Model 1906



Rifle taken apart

sliding forearm backward and forward unlocks, opens, and cocks the rifle, forces the cartridge into the chamber, and locks the rifle. The rifle once closed is locked while the hammer stands at full or half cock. To open the action without firing or letting down the hammer, push forward the firing pin with the thumb, and pull back on the sliding forearm at the same time. When the hammer stands at half cock, the rifle is locked both as to the opening of the breech-block and the pulling of the trigger. The hammer cannot be cocked by the opening motion of the breech-block from this position, but must be cocked by hand.

To take down the rifle. Turn out the assembling screw (a stop pin prevents its dropping completely out), hold the arm by the barrel, with the left side down, and pull the stock from the barrel. Put the rifle together in the same position, first letting down the hammer, and pushing the breech-block to its forward position.

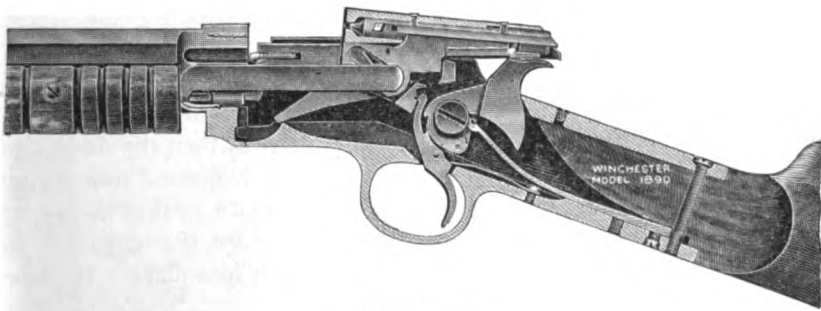

Action open

To dismount the gun. Take down the gun: All pins drive out from right to left. To take out the breech-block, remove the magazine ring pin; draw out the magazine; slide out the cover plate; lift out the action slide; press on the firing pin, unlock the breech-block and draw it out backwards. To take out the extractor, drive out the extractor pin from the bottom of the breech-block. To remove the firing pin, take out the firing-pin stop screws and remove the firing pin stop. The firing pin can then be drawn out. To remove the hammer and carrier block from the tang, take off the stock, loosen the mainspring strain screw and the mainspring screw; slide the stirrup off the mainspring, pressing down the mainspring to accomplish this. The mainspring can then be swung out sideways. The assembling screw and assembling screw bushing can then be removed and the hammer

taken out. Take out the trigger; loosen the trigger spring screw; drive out the trigger pin.



Action closed

To assemble the gun. Put in the trigger and trigger spring, carrier and hammer, and slip in the hammer pin. Slide the stirrup over the mainspring and tighten the mainspring screw and mainspring strain screw. Put the firing pin in the breech-block, and replace firing pin stop and stop screws. Replace extractor, driving in pin from top. Slip the breech-block into the frame. Replace action slide, and put on the slide cover. Replace magazine. To do this, turn the magazine so that the loading hole is next the barrel; slip the magazine stop spring in place; slide the magazine with stop spring in place so that the lower end of stop spring is under the magazine ring; turn the magazine so that stop spring comes next the barrel, and push it into place. Replace the magazine pin. Replace the butt stock.

The Model 1890 rifle has been in use now for over twenty years, and has always given splendid satisfaction. It can be regarded as absolutely reliable in every respect. It is the favorite rifle for the popular shooting galleries, and is there given almost constant use, and very hard use at that. It has been demonstrated times without number that if the rifle is properly taken care of, used with black, Lesmok, or semi-smokeless powder entirely, and never with smokeless powder cartridges, also when in constant use in the shooting gallery cleaned at least every 100 rounds, it will practically last a lifetime, and give good accuracy all the time. I have seen many of these rifles which have been fired over 100,000 times, and that are still giving fine accuracy.

For sporting use the models to be recommended are the Model 1890 firing the Winchester rim-fire cartridge, which is a fine grouse and squirrel rifle; and the Model 1906 which should be used only with

the .22 long rifle ammunition. The latter cartridge is the most accurate .22 rim-fire cartridge made, and the firing of the .22 short cartridge in a rifle chambered for the .22 long rifle cartridge, while possible and practical, will ultimately result in the ruination of the barrel through the burning out of the chamber. The .22 short cartridge should only be used in a rifle which is chambered and rifled for it alone.

WINCHESTER REPEATING RIFLE,
MODEL 1892

This rifle is exactly the same as the Winchester Model 1886, and everything that has been said regarding that rifle pertains as well to this. The rifle is adapted to the .25-20, .32-20, .38-40 and .44-40 Winchester center-fire cartridges. It is regularly made with barrels of ordinary steel, and weighs from 6¼ to 7½ pounds. In .25 caliber particularly it is always best to obtain to special order a nickel-steel barrel, as it is extremely hard to keep one of these small bore rifles clean when using smokeless powder when the barrel is made of ordinary steel. When this rifle is made with half-magazine, pistol-grip stock, and shotgun butt plate, it balances excellently and is a most pleasant rifle to handle and shoot. By far the best rear sight that can be placed on this rifle is the Lyman No. 103 which can be obtained to special order for it. This sight has adjustments for both elevation and windage which read to half an inch at 100 yards, and with it all is a perfect hunting sight for rough work.

Owing to the cartridges to which it is adapted this rifle is essentially a short-range arm, and for that purpose is a most excellent model because it can probably be operated faster and easier than any other lever action arm on the market.

Fancy sporting rifle, Model 1892

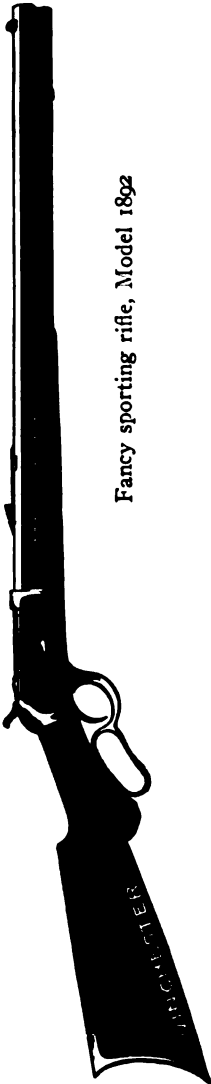

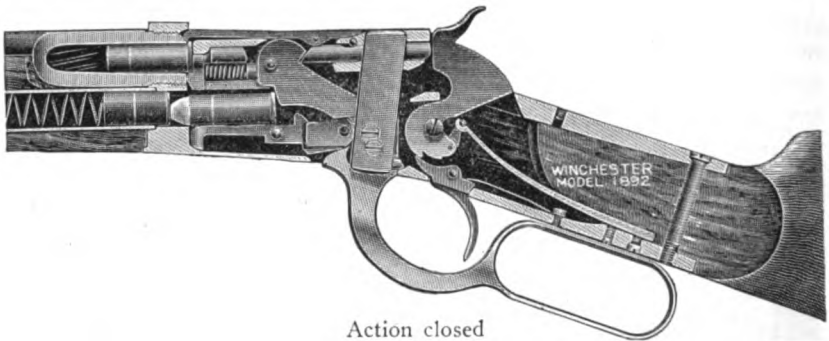

Action closed

To dismantle the gun. Take off butt stock. Throw down the lever. Turn out the mainspring strain screw until it does not bear on the spring. Take out the mainspring screw and mainspring. Take out the hammer screw. Withdraw the tang and slip out the hammer. Remove the finger lever pin stop screw (this is the forward screw on the left-hand side of the frame). Drive out the finger lever pin. A hole is left on the right-hand side of the gun, through which a punch may be used to drive out the pin. The pin is opposite this hole when the breech-bolt is in its most forward position. Throw the lever down and draw out the lever with the locking bolts attached. Remove the breech-bolt. Take out the two carrier screws and remove the carrier by pushing it backwards. Remove the cartridge guide screws and take out the guides.

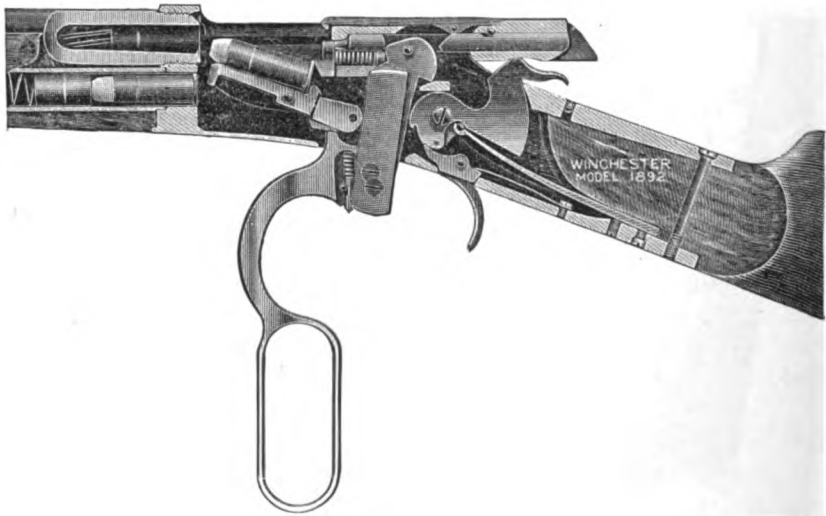

Action open

To assemble the gun. Slip in the carrier from the lower side. To do this it will be necessary to push in the carrier stop so that the carrier will slip into place between the walls of the frame. Replace the cartridge guides. The cartridge stop spring in the left-hand guide should be assembled with its point under the cartridge stop and concaved side towards the receiver. Put in the bolt with the ejector, ejector spring, and collar assembled. Assemble the locking bolts upon the lever and push them, with the lever, into place from the lower side of the gun. Replace the finger lever pin and stop screw. Slip in the tang. Put the hammer in place and put in the hammer screw. Assemble the mainspring loosely on the tang. Catch the stirrup over the end of the mainspring before screwing it fast. Screw fast the mainspring screw and mainspring strain screw.

WINCHESTER REPEATING RIFLE, MODEL 1894

This is a tubular-magazine, repeating rifle that was placed on the market in response to a demand for an efficient repeating rifle to handle the popular .32-40 and .38-55 cartridges. It was originally designed for black-powder cartridges. Owing to its light weight and handiness it at once became very popular with sportsmen, particularly for deer hunting. In May, 1895, the famous .30-30 cartridge was adapted to it, a nickel-steel barrel being furnished for this cartridge. In this caliber the rifle became enormously popular, owing to its good points as a rifle, and also because the .30-30 cartridge proved so far ahead of all-black-powder cartridges for ordinary American sporting use. It is safe to say that even today this rifle in .30-30 caliber has a larger sale than any other American big-game arm. Later on the .25-35 W. C. F., and the .32 Winchester special cartridges were also brought out and adapted to it.

The mechanism has ample strength for the cartridges it handles. The breech bolt, worked by a finger lever, is automatically locked and supported by a vertical moving block, which shows on the top of the rifle when it is closed, and covers the whole rear of the breech bolt. The firing pin is automatically withdrawn and the trigger locked until the parts are in the firing position. In order to obtain sufficient movement to the rear of the breech bolt to handle the long cartridges adapted to this rifle, the under surface of the receiver (called the "link") drops down, pulling down the locking block and the pivot of the finger lever with it, when the action is opened, and is lifted back into place by the closing movement of the lever. As the lever opens,

THE AMERICAN RIFLE



Fancy sporting rifle, Model 1894

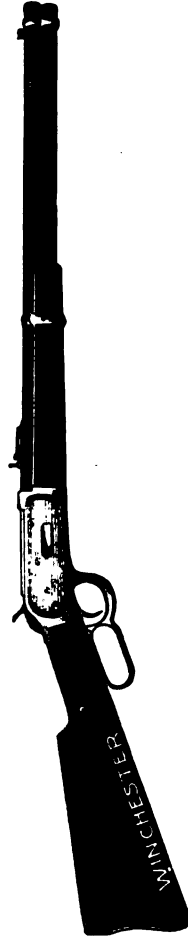

Carbine, Model 1894

the cartridge in the magazine is permitted to move to the rear, being forced back by the magazine spring until it lies in the carrier. The latter part of the opening movement of the finger lever lifts the carrier up so that the cartridge is presented in front of the breech bolt in position to be forced into the chamber by the closing movement of

the breech bolt. The arrangement of the carrier and link are such as to prevent the escape of more than one cartridge at a time from the magazine, and to permit of the use of cartridges slightly shorter than the standard. The operation of the rifle will be readily understood from the sectional cuts of the action.



Action closed

To dismount the gun. Take out the tang screw and remove the butt stock. Take out the finger lever pin stop screw and finger lever pin. Take out the link pin screw and link pin. Take out the finger lever and link. Take out the finger lever link screw, and separate the link from the finger lever. Take out the carrier screw from each side of the gun, and remove the carrier. Take out mainspring screw and mainspring. Take out the hammer screw and hammer, holding up safety catch pin while doing so. Take out lower tang. Take out lock-

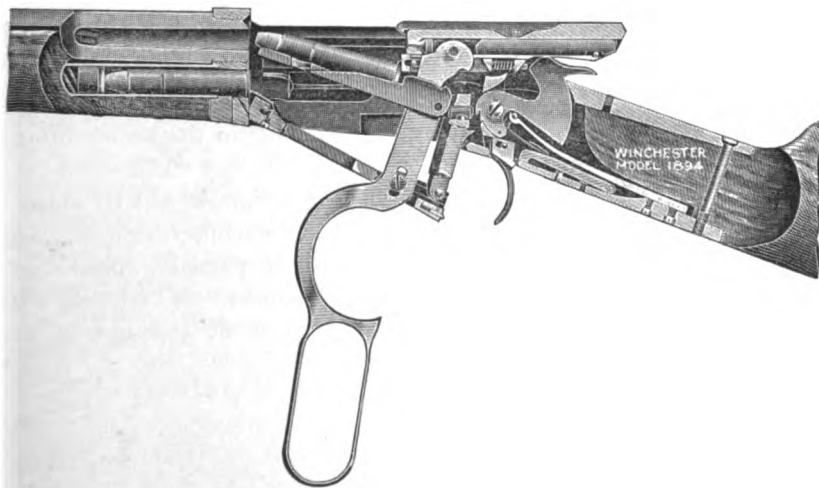

Action open

ing block. Take out the breech-bolt. Take out the cover spring screw and cover spring. Take out the carrier spring screw and carrier spring.

To assemble the gun. Put in the carrier spring and carrier spring screw. Put in the cover spring and cover spring screw. Slip in the breech-bolt. Slip in the locking block from below. Put the hammer in place, and slide the tang into place. Put in the hammer screw, remembering that the sear cannot be moved without pressing up the safety catch pin. Catch the mainspring on to the stirrup, and put in the mainspring screw. Put in the carrier and replace the carrier screws, one on each side. Assemble the link to the finger lever. Push the finger lever partly up into the gun, and catch the rear end of the link upon the locking block. Put in the link pin, and the link pin screw. Close the link into the gun, put in finger lever pin and finger lever pin stop screw. Slip on the stock, and put in the tang screw.

The Model 1894 rifle is at its best when made up either with 26-inch round barrel, half magazine, pistol grip, and shotgun butt; or in carbine form. Both of these models are light, and balance and handle well. The carbine is preferable for rough work, and for quick shooting in thick brush, as well as for horseback.

By far the best rear sight for this rifle is the Lyman No. 103 rear tang sight, which has adjustments for both elevation and windage reading to half an inch at 100 yards. While this is the best target sight on the market, it is also splendidly adapted for hunting, and is as strong and solid as any.

The rifle is made in take-down form as well as solid frame, but the latter model should always be chosen as the accuracy and maintenance of elevation and zero of take-down rifles can never be depended upon. It is not so much a matter of the take-down becoming loose, as it is the introduction of a second joint in the center of the rifle which gives variable flip and vibration.

In some rifles that have been in use a long time it will be noticed that the finger lever often drops down at inopportune moments, partially opening the action, or even that the action partially opens when the rifle is fired. This is caused by the wearing of the friction stud at the rear end of the link, and the substitution of a new stud will completely correct the trouble.

WINCHESTER REPEATING RIFLE, MODEL 1895

This rifle was placed on the market to handle the more powerful of the modern cartridges which were so long that they could not be successfully handled by the old-style, tubular magazine rifles. It was the first box-magazine, lever-action rifle placed on the market. It was first brought out in a model somewhat different from the present type, having a different finger lever, and a slightly different receiver. A little experience with this first model showed that a secure lock for the finger lever was necessary by reason of the peculiar construction of the action, and the present model took its place. Very few of the first model were sold, it being adapted to the .30-40 U. S. cartridge (Krag), the .236 navy cartridge, the .38-72 and .40-72 black-powder cartridges. The new model was made for all these cartridges except the navy cartridge, but the manufacture of this rifle for the black-powder cartridge was discontinued several years ago. At present this rifle is being made to handle the following cartridges: .30-40 U. S. Government; .303 British; .30 Model 1903; .30 Model 1906; .35 W. C. F. and .405 W. C. F. It is made in sporting, carbine, and musket styles, all having round, nickel-steel barrels.

The receiver, open at the top, permits the symmetrical locking of the breech bolt. The first opening motion of the finger lever withdraws the trigger from contact with the sear, before the gun is unlocked, so that it is impossible to fire the gun except when fully locked. The continued opening motion of the lever draws down the locking bolt and withdraws the breech bolt, cocking the rifle and ejecting the cartridge or fired shell. The breech bolt, passing over the hammer, presses the firing pin lock against the latter, and makes fast the firing pin. When the breech bolt is in its rearmost position the hammer is made to hold it open by contact, so that the magazine may be easily loaded. When in this position the upper cartridge in the magazine is so presented as to engage the breech bolt.

The closing action of the lever carries forward the breech bolt, forcing the cartridge out of the magazine into the chamber. After the breech bolt has reached its closed position, the locking bolt is lifted into place, first locking the rifle, and afterwards unlocking the firing pin. The final closing movement of the lever presents the trigger against the sear, leaving the rifle in position for firing.

The magazine is of the box type, and presents the cartridges to the lower front edge of the breech bolt in position to be forced into the

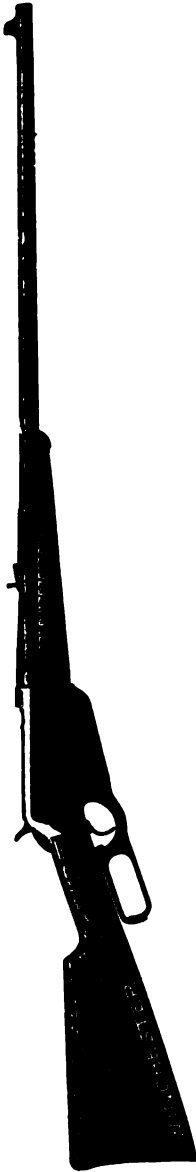

Winchester repeating rifle, Model 1895, fancy finish, 28-inch round, nickel steel barrel, shotgun butt-stock, caliber .30-40 U. S.



Fig. 6
A special Winchester Model 1895 rifle belonging to the author, and used by him for a number of years. Caliber .40-72, heavy No. 3 half-octagon barrel, and hand-made, pistol-grip stock.



Fig. 7
Winchester repeating rifle, Model 1895, Roosevelt Model, caliber .405 W. C. F. Lyman receiver sight. This rifle is exactly the same as that used by Hon. Theodore Roosevelt in Africa, except as to the sights.

chamber, and is arranged to prevent the escape of the cartridge following before the preceding one is in the grasp of the extractor, thus preventing the jamming of the rifle by false movement. The opera-

tion of the rifle can be readily understood by an examination of the sectional cuts showing the action.

The rifle is loaded by opening the action, grasping a cartridge with the bullet between the thumb and forefingers, and forcing the head of the cartridge between the lips of the magazine. Then move the head of the cartridge to the rear of the magazine against the face of the breech bolt, and turn the cartridge down forward into the magazine, following with the thumb until the entire cartridge lies in the grasp of the lips of the magazine. Repeat with each cartridge. Rifles chambered for the .30-40 and .303 British cartridges hold five cartridges in the magazine. The others hold only four cartridges, which with one in the chamber, makes five shots at the command of the rifleman.

The rifle is made in both solid frame and take-down models, the former being always advised for reasons stated in Chapter XIX.



Action closed

To dismount the gun. Remove the forearm and butt stock. Open the lever and remove the carrier screw and magazine tip screws. (These are the three lower screws in the forward end of the receiver.) Remove the magazine with the inclosed carrier, turn out the mainspring strain screw, take out the mainspring screw and mainspring. Close the lever and remove the hammer screw and hammer. Remove the finger lever pin stop screw and drive out the finger lever pin from the forward hole in right side of receiver. Remove the link pin. (This connects the link with the lower tang.) The finger lever, link and trigger can then be removed together. Take out the sear spring screw (the forward screw on the bottom of the lower tang) and the sear pin. Take out the locking bolt and breech-bolt.

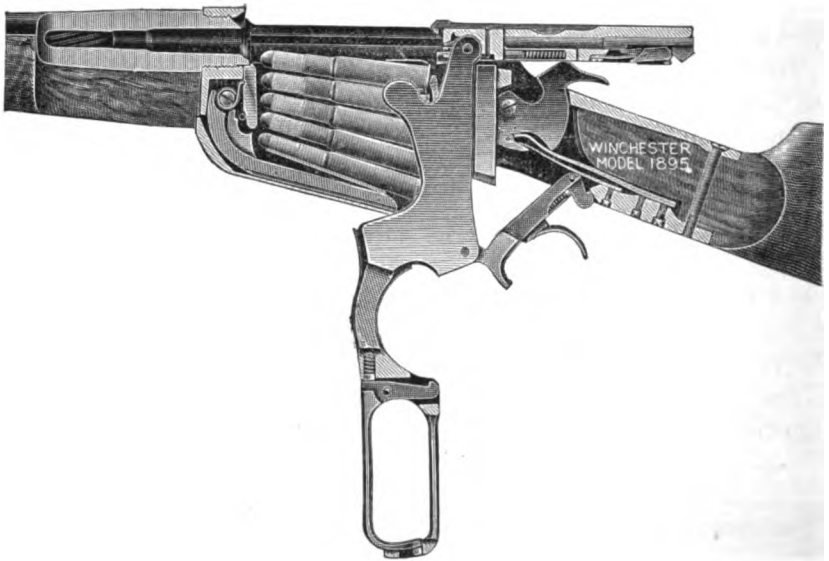

Action open

To assemble the gun. Put in the breech-bolt, assembled complete with firing pin, extractor and ejector. Put in the locking bolt. Put in the sear, sear pin and spring. Put in the finger lever and drive in the finger lever pin from the left side. Put in the finger lever pin stop screw. Attach the link to the lower tang by the link pin and drive in the finger lever link pin, connecting the link with the finger lever. (This link should be attached to the tang with the trigger and finger lever catch all assembled.) Put in the hammer and hammer screw. Put in the mainspring and mainspring screw, and turn up the mainspring strain screw. Put in the magazine with carrier in place. Insert the carrier screw through the receiver, magazine and carrier. Replace the forearm and butt stock.

Until the advent of the Newton rifle, the Winchester Model 1895 was, generally speaking, the only rifle made in America which used cartridges that can be considered as powerful enough for all kinds of American game. The rifle is very strong and reliable. Its functioning is absolutely sure provided one takes the precaution of always operating the lever to its fullest extent; that is, working it hard, throwing it fully open and fully shut each time. It permits of using uncrimped ammunition and pointed bullets which cannot be used satisfactorily in the tubular magazines. This rifle has been used with great

success for twenty years by sportsmen all over the world, and has always given splendid satisfaction, except in one particular. On account of the protruding magazine and the balance it is rather an uncomfortable rifle to carry. The magazine precludes the rifle being carried in the usual way, barrel up, on the shoulder, and also comes just where the hand grasps it when it is carried at a trail; that is, in the hand, by the side, with the barrel horizontal. These faults can, however, be forgiven in view of its other good points. There is very little to get out of order or break about the action, which is unusually simple for a lever-action arm. One good feature is the unusual strength of grip, which insures against breakage in the field and also contributes to the good shooting qualities of the rifle.

One feature this rifle shares with all lever-action rifles made in this country, but it is more evident in the Model 1895 than in the others because it uses ammunition having a higher breech pressure. I refer to the elasticity of the action, which allows a certain spring to the breech bolt when cartridges developing pressures of much over 42,000 pounds per square inch are used. This springing of the breech bolt permits the stretching of the fired shells, so that shells fired with high pressure in lever actions are stretched so that they cannot be reloaded satisfactorily. They will not fit the chamber after they have once been fired without undue force being used on the lever to close the action. The body of the shell is stretched, and this cannot be overcome with a shell resizing die. As a result when the more powerful cartridges are used in this rifle it will be necessary to use new shells for special loads, and if one wishes to use reduced loads he will have to get new shells for them also, although shells that have only been fired with reduced loads can be used indefinitely for these loads, or used once for the full charge. This trouble is not experienced to any extent in the .30-40 or .303 British cartridges.

This rifle cannot be used with the ordinary Lyman combination tang sight as the breech bolt has such a long travel to the rear that it interferes with the sight on the tang. The only tang sight that can be used is that with flexible base made by the Marble Arms and Tool Co. This sight is held in position by a spring, and when the breech bolt comes to the rear the sight is pushed down by it. As the breech bolt moves forward in closing the rifle, the sight springs up into firing position again. This sight is the correct one for Model 1895 rifles chambered for the .30-40 and .303 British cartridges. The other cartridges for this rifle, however, develop a little too much

recoil for a tang sight; there is liability of the sight hitting the rifle-man in the eye during the recoil, particularly in the hunting fields, where it is not always possible to take a firm, regular standing position as one naturally does on the target range. When a rifle with one of the heavier cartridges is used, by far the best rear sight is the Lyman No. 41 receiver sight with wind gauge. The No. 21 sight usually seen on this rifle does not permit of sufficient delicacy of adjustment for elevation.

It is recommended that the rifle be always equipped with shotgun stock, and with a checked steel butt plate, which can always be obtained on special order without extra charge. The rifle butt plate increases the recoil, and makes snap shooting more difficult, and rubber butt plates will not stand the wear and tear of real wilderness hunting, particularly in mountainous countries where it is absolutely necessary sometimes to use the butt of the rifle as an aid to climbing, particularly in rock work.

WINCHESTER SINGLE SHOT RIFLE

I consider this the strongest and most reliable rifle action ever made. Of course it is a single shot, and there is no excuse for such a rifle not being strong and reliable, as it has only to open and close to receive the single cartridge loaded by hand and is not called upon mechanically to take a cartridge out of a magazine, insert it in the chamber, and finally withdraw and eject it, as repeating rifles are. This has always been my favorite action, particularly for target shooting and experimental work, testing, etc. Even as a young boy of thirteen I strongly admired one of these rifles exhibited in the window of a local gun-store, and longed for the time when I could possess one. At the present time I own no less than seven of them for various cartridges, and have at one time or another owned eighteen. It is the best action made for Schuetzen target shooting, and is the favorite one to which to attach special Pope and Neidner hand-made barrels. The barrels that the Winchester Company regularly equip this rifle with are the best commercial barrels for accuracy that it is possible to obtain. I have one of these rifles for the .30-40 cartridge with regular Winchester barrel, which in many years has never missed a 2½ inch circle at 100 yards that has not been my fault. The rifle makes a most excellent hunting rifle too, when speed of fire is not a necessity. I used this same .30-40 single shot for one season's big-game hunting in British Columbia, as well as on many hunts in the tropical jungle

of Central America, and I never had any fault to find with it, even when rapidity of fire was considered, except only when my hands were numb with cold, making the handling of the cartridge and loading a slow operation. I have often gotten in two or three shots

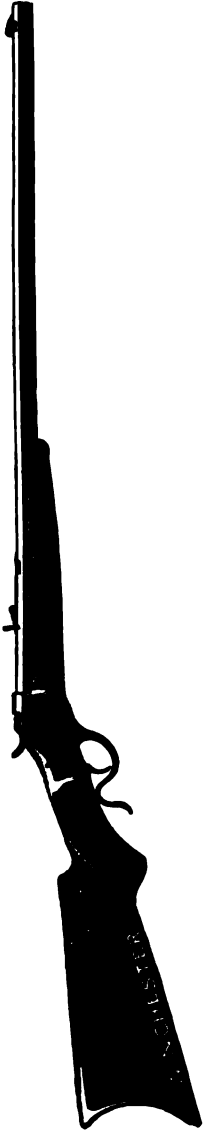

Winchester single shot rifle, fancy finish, pistol-grip stock, rifle butt-plate, and octagon barrel

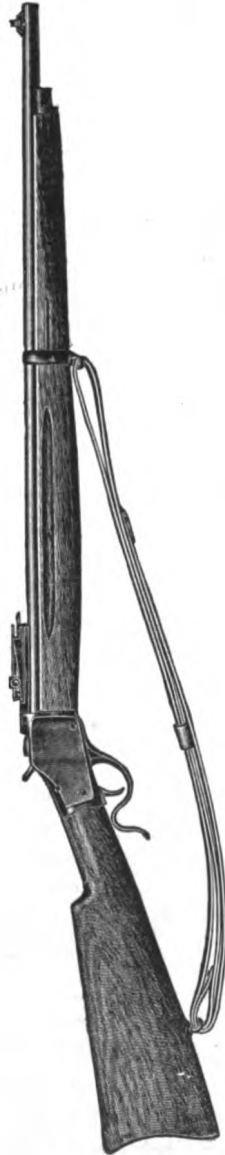

Winchester single shot musket, caliber .22 long rifle rim fire. A very popular arm for short range target shooting among the clubs associated with the National Rifle Association.

at running game with it. When a man has used a certain rifle for twenty years and it has never failed him a single time, he acquires a certain respect and attachment for it.

The Winchester single shot rifle is made in a great variety of calibers from the tiny .22 rim fire to the big .405 W. C. F. and .45-70 cartridges. At one time or another this rifle has been made for practically every cartridge that the Winchester Company has produced, but at the present time it is being made only for the most popular cartridges. It is regularly made only for cartridges having a rimmed shell, but a few have been made to order for the National Rifle Association adapted to the rimless .30 Model 1906 cartridge. It is usually put out with a heavy barrel, especially for the larger cartridges. This barrel is called the No. 3, and rifles with it weigh in the neighborhood of nine pounds. This heavy barrel is free from the vibrations that influence all thin barrels to a certain extent, and it holds its elevation and zero splendidly, especially when the rifle is one with solid frame. These No. 3 barrels are regularly made 30 inches long. This is longer than necessary, and I have adopted for myself a standard of 27-inch barrel, pistol grip, and shotgun butt plate. As so made the rifle balances finely, and one would scarcely believe that it weighed as much as nine pounds.



Fig. 8

Winchester single shot rifle, caliber .30-40 U. S. owned by the author. Equipped with Winchester telescope sight, Marble flexible rear sight, Lyman ivory bead windgauge front sight, pistol-grip, shotgun butt-stock, and 27-inch No. 3 round barrel of nickel steel.

This rifle has a sliding breech-block which drops down through slots in the receiver when the finger level is opened, thus allowing access to the chamber for loading, and also permitting the rifle to be cleaned and examined from the breech. The breech-block is supported by the heavy slots in the interior walls of the receiver, and by the whole of the rear part of the receiver. It is impossible for the breech-block to open up or blow back during firing, except by force which would destroy the entire action. The firing pin is automatically withdrawn

at the first opening movement of the rifle, and held back until the rifle is closed. The hammer is centrally hung and drops down with the breech-block. On closing the breech-block the hammer formerly came to full cock, but the rifle is now made so that it comes only to half cock when the action is closed. It can be made to order, however, to come to full cock as in the early model. Single and double-set triggers can be furnished for the rifle, and are desirable if the arm is to be used only for target shooting of testing ammunition. For a hunting rifle I very much prefer the single trigger which can be adjusted to pull at any weight by a good gunsmith. I have mine adjusted to just two pounds, and they are all mighty sweet, clean pulls.

The firing pin I have not found altogether satisfactory, especially where smokeless cartridges and non-mercuric primers are used. It misses fire occasionally, and sometimes punctures the primers when used with such ammunition. The late Dr. Mann invented a firing pin for this action which is most perfect, and completely cures this trouble, as well as permitting enormous charges to be fired in the rifle with a complete absence of primer troubles. This firing pin can only be adjusted to the rifle now by Mr. A. O. Neidner of No. 18 Beacon Street, Malden, Mass., he alone having the plans and specifications for it. In deference to the desire of Dr. Mann, expressed to me before his death, I defer from describing it here. I believe he intended to describe it in a book that he was preparing at the time of his death.

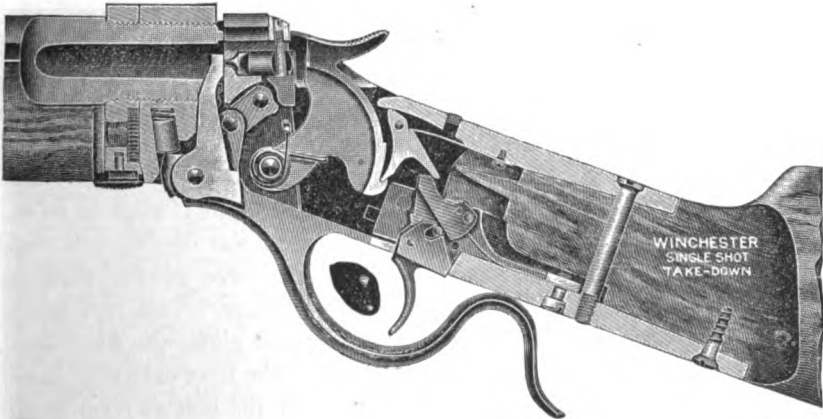

Action closed

To dismount the gun. Take off the forearm. Take out the ejector spring. Loosen the stop screw and take out the finger lever pin.

Draw out the breech-block by the finger lever with the hammer attached. The extractor will drop out. If it is desired to remove the trigger or sear, take off the stock. Remove the side tang screws and tang; the pieces attached to the tang can then be removed by pushing out the pins which hold them. Remove the sear spring screw and spring.

To assemble the gun. Replace the sear spring and screw. Mount the trigger and other parts of the lock on the tang, and slide it into place. Replace the side tang screws. Assemble together the hammer spring, hammer, breech-block, and finger lever, and hold them in the same relation to each other as shown in the cut; that is, the firing pin protruding, and the hammer against the breech-block. In this position push them from the under side of the gun partly into position. Put in extractor, and push the whole into place, holding back the trigger, so that the sear may not catch on the hammer. Open action, replace ejector spring, taking care to see that its inner end rests in its seat on the extractor. Replace stock and forearm.

WINCHESTER SELF-LOADING RIFLES,
MODELS 1903, 1905, 1907 AND 1910

The operation of all the Winchester Auto-Loading Rifles is practically identical. The recoil from the fired cartridge ejects the empty shell, cocks the hammer, and throws a fresh cartridge into the chamber. Integral with the breech-block is a heavy weight so arranged that the weight lies in a recess in the forearm. This weighted bolt is held forward so that its face comes against the opening of the chamber by a heavy bolt spring. When the recoil of the fired cartridge comes on the face of the bolt the inertia of the weight has first to be disturbed, putting the bolt into motion, and moving it to the rear against the tension of the bolt spring. The inertia of the weight is such as to delay the starting of the backward movement of the breech bolt until the bullet has left the barrel, and the whole force of the recoil is sufficient to fully operate the breech bolt to the rear. This rear movement of the breech bolt from recoil extracts and ejects the fired shell, and presents the head of the bolt in the rear of the next cartridge in the magazine which has been forced up in front of the bolt as soon as the latter reaches its rearmost position, by the action of the magazine spring. The bolt having been forced to the rear by the recoil, the bolt spring then acts to move it forward into its original place, closing the bolt,

forcing the top cartridge into the chamber, and leaving the rifle cocked and ready for instant firing. To operate the rifle it is necessary for the first shot to fill the magazine, and then to push quickly back on the operating sleeve, which will be found projecting just in front of the forearm tip. This operates the breech bolt exactly as firing would have done, and places a cartridge in the chamber of the rifle, leaving the rifle full cocked and ready for firing. To fire the rifle it is necessary only to pull the trigger, the action operating itself by recoil. The instant the rifle is fired it is all ready for firing again, but the trigger has to be pulled for each shot. When loaded and all ready for firing the rifle can be locked by pushing the safety, found on the trigger guard just in rear of the trigger, to the left. Immediately after firing each shot the trigger should be released, allowing it to move fully forward. The operation of this type of rifle will easily be understood by an examination of the sectional cuts.

The Model 1903 rifle is a .22 caliber, using the .22 Winchester Automatic smokeless cartridge. The magazine is contained in the butt stock, and the rifle is loaded by holding the rifle muzzle down, and turning the magazine plug, seated in the depression in the butt-plate, to the left, drawing out the magazine tube until the magazine follower clears opening in stock. Drop the cartridges, bullet foremost, through the opening in the right side of the stock into the magazine. Push in the magazine tube and lock it by turning the magazine plug to the right. This is an excellent little arm for fancy rifle shooting, and for all use where extreme rapidity of fire in a .22 caliber is desirable. The cartridge is not quite as powerful as the .22 long rifle cartridge, being inside lubricated, and having a 45-grain bullet with a muzzle velocity of 903 feet per second. It is to be regretted that the cartridge manufacturers have never brought out a cartridge for this rifle loaded with Lesmok or semi-smokeless powder. The smokeless cartridge is quite accurate but will sooner or later ruin the bore of the rifle through pitting, and no known way of cleaning will prevent this. In such a case the only thing to do is to send the rifle to the factory to have a new barrel fitted. The cartridge has a hardened bullet that does not expand well on animal tissue, and as a consequence it has hardly sufficient killing power for even the smallest game. Too much wounded game will escape, and in the interests of humanity this rifle should never be used on game larger than English sparrows and rats.



Winchester self-loading rifle, Model 1903, fancy finish

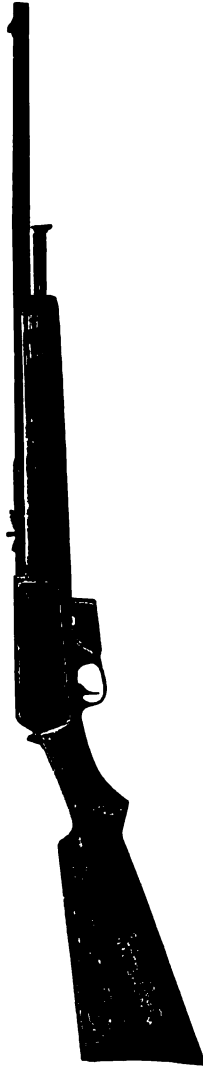

Winchester self-loading rifle, Model 1905, plain finish

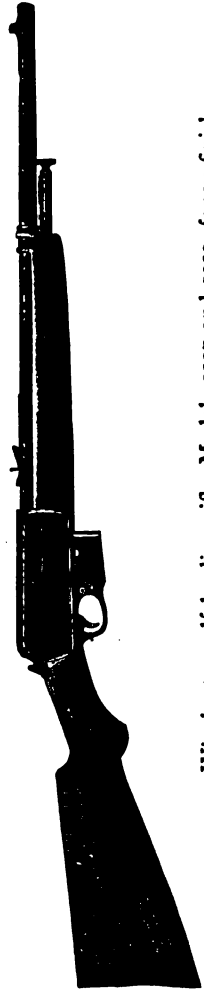

Winchester self-loading rifle, Models 1907 and 1910, fancy finish

INSTRUCTIONS FOR DISMOUNTING AND ASSEMBLING THE WINCHESTER
SELF-LOADING RIFLE, MODEL 1903

To dismount parts attached to the receiver. Take down gun by unscrewing take-down screw. Note that all pins are driven out from left to right. Remove forearm tip screws. Draw forearm tip forward, and free it from forearm tip tenon together with operating

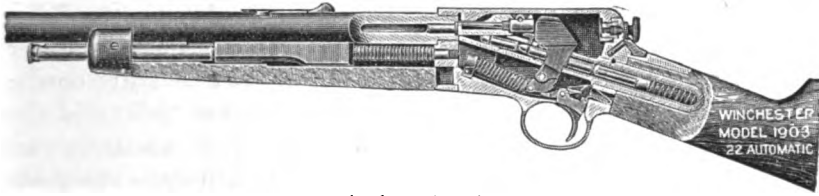

Action closed

sleeve. Remove operating sleeve spring. Remove forearm tip tenon, driving from right to left. Remove forearm. Unscrew bolt guide rod and draw it forward out of bolt. Remove bolt spring. Retract bolt to rear of receiver and lift rear end of bolt away from top of receiver and withdraw from receiver. Remove ejector screw and drive ejector to rear. To remove extractor, take out extractor plunger stop screw; insert thin instrument such as a knife blade between extractor and extractor plunger; retract extractor plunger to fullest possible extent, and then extractor may be lifted out. Remove the extractor plunger and spring. To remove firing pin and bolt roll, drive out firing pin stop pin, releasing bolt roll. Withdraw firing pin and firing pin spring. To replace extractor, insert extractor spring and plunger in extractor spring hole and retain plunger in its retired position by means of pin or other small article, pressing on its forward end through extractor slot. Insert extractor until it rests upon the pin which is maintaining extractor plunger in retired position. Withdraw pin and push extractor down in its original position. Replace extractor plunger stop screw. Assemble other parts contained in receiver in reverse order.

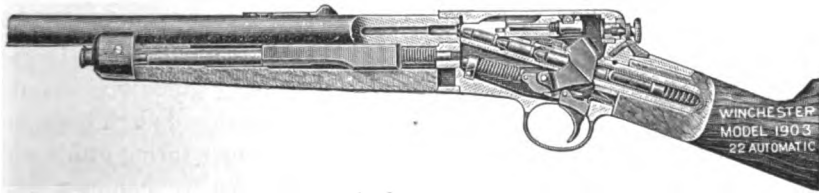

Action open

To dismount parts attached to the tang. Turn magazine plug to the left and withdraw inner magazine tube. Remove butt plate screws and butt plate. Unscrew butt stock nut. (A split screw-driver is necessary for this in order to straddle outer magazine tube.) Take off butt stock. Withdraw trigger lock plunger and spring from rear of tang. To remove magazine friction spring, drive forward out of dovetail cut in which it is seated, using the small hole in the spring

base as a driving point. To remove hammer, allow hammer to assume its forward or dropped position. Drive out hammer spring abutment pin and turn hammer spring abutment to one side and lift out, relieving strain on hammer spring. Drive out hammer pin, and slide hammer, with spring and hammer spring guide rod attached, forward. To remove cartridge cut-off, drive out pin, and cartridge cut-off with spring can be lifted out. To remove sear and trigger, drive out trigger pin and withdraw trigger through guard, and trigger spring may be withdrawn from its seat in rear of tang by forcing it forward into trigger slot. Push out trigger lock from either side. It is not advisable to remove magazine throat from tang, as these parts are put together so snugly that they are liable to be damaged unless proper appliances are at hand for removing them. To remove take-down screw lock and spring, drive out stop pin in shank of take-down screw, remove take-down screw, drive out take-down screw lock pin, and withdraw take-down screw lock and spring.

To assemble parts in tang. Replace take-down screw lock and spring, and drive in take-down screw lock pin, holding take-down screw lock in the tang. Insert take-down screw and replace take-down screw stop pin, replace cartridge cut-off and trigger spring. Replace trigger lock with the letter "L" on the lower right hand side; replace trigger and sear, taking care that sear spring is properly seated in sear. Slip hammer with spring and hammer spring guide rod attached over throat as far to the rear as possible, maintaining meanwhile a rearward draught on sear so that base of hammer may pass well back on top of sear. While hammer is in this rearward position, slip in hammer spring abutment, and replace hammer spring abutment pin. In placing hammer spring abutment, it should be noted that the larger side of the hole for passage of the hammer spring guide rod should be on forward side. Press base of hammer forward and align hammer pin hole with its opening in the tang, entering hammer spring guide rod through hole in hammer spring abutment, and replace hammer pin. Replace trigger lock plunger and spring. Replace butt stock.

The Model 1905 rifle handles the .32 and .35 Winchester self-loading cartridge. The Model 1907 handles the .351 Winchester self-loading cartridge, and the Model 1910 the .401 Winchester self-loading cartridge. These models are all practically identical except as to cartridges and calibers. The magazine, situated in front of the trigger guard, is detachable by pressing forward on the magazine lock found on the right side of the forward end of the guard. Then

pull out the magazine. The action should always be closed before placing the magazine in the rifle. To fill the magazine, detach it from the rifle and press the head of the cartridge on the magazine follower or preceding cartridge, immediately forward of the curved lips of the magazine. Press the cartridge down and back under the magazine lips until it slides into the magazine. Place the magazine in the rifle. To load, quickly push back the operating sleeve as far as it will go and let it spring forward.

The mechanism of all these rifles is so simple that it is not at all liable to get out of order if given anything like proper care. It should be kept clean and oiled with a light oil. These rifles have been in use now for a number of years and have proved very reliable in their functioning, practically as much so as the best hand-operated, repeating rifles. They are excellent for any use where rapidity of fire is desired, particularly for the shooting of medium-sized game in thick cover.

INSTRUCTIONS FOR DISMOUNTING AND ASSEMBLING THE WINCHESTER
SELF-LOADING RIFLES, MODELS 1905, 1907 AND 1910



Action closed

To dismount parts attached to the receiver. Cock hammer, release and unscrew take-down screw, take gun apart. Note that all pins are driven out from left to right. Remove forearm tip nut. Draw forearm tip with operating sleeve forward. Draw forearm forward, unscrew bolt guide rod and draw it out of bolt. Remove bolt spring. Do not remove washer and buffer. Retract bolt to rear of receiver, lift forward end away from barrel and remove. Ejector is permanently fixed in receiver and can be removed only by unscrewing barrel from receiver. This should not be done. To remove extractor, take out extractor plunger stop screw, insert thin instrument, such as a knife blade, between extractor and extractor plunger, retract extractor plunger to fullest possible extent, then extractor may be lifted out.

Remove extractor plunger and spring. To remove firing pin, drive out firing pin stop pin from below, withdraw firing pin and firing pin spring.

To assemble parts attached to the receiver. When replacing firing pin, drive firing pin stop pin in from above with flat end of pin down, so that crowned end is below top surface of bolt. To replace extractor, insert extractor spring and plunger, and retain plunger in its retired position by means of pin or other small article, pressing on its forward end through extractor slot. Insert extractor until it rests upon the pin which is maintaining extractor plunger in retired position. Withdraw pin and push extractor down into its original position. Replace extractor plunger stop screw. When replacing bolt — in case washer and buffer have been removed — insert steel washer on top of buffer. The operating sleeve spring must be compressed in operating sleeve, and retained in this position while assembling, by a pin through hole in side of operating sleeve. Assemble other parts contained in receiver in reverse order from that in which they were dismantled.



Action open

To dismantle parts attached to the guard. Press magazine lock inward and withdraw magazine. Remove butt plate, unscrew butt stock bolt and take off butt stock. To remove hammer; remove timing lever spring screw and spring, drive hammer pin part way out and remove timing lever. With thumb resting on face of hammer, pull trigger, allowing hammer to assume forward position, drive hammer pin out. To remove sear and trigger, drive out trigger pin, remove the sear, sear spring and trigger, push trigger spring forward and out from rear. To remove trigger lock, insert pin or other small article through hole in trigger lock, press trigger lock plunger downward, and at the same time push trigger lock out from right to left. Remove trigger lock plunger and spring. To remove take-down screw and take-down screw lock, drive out stop pin in shank of take-down screw, and remove take-down screw. Remove take-down screw lock by pushing it forward and upward from rear of guard. Remove magazine lock screw, magazine lock, and magazine lock spring. Assemble in reverse order. Note that trigger lock is assembled with letter L down and on right hand side of gun.

To dismount the magazine. Raise up front end of follower and pull it clear of magazine.

To assemble the magazine. Replace spring with large portion down, and with cut-off end toward rear. Place follower on spring with end hooked over stud underneath. Press follower down and slide it under lips of magazine.



Rifle taken down.

To take down the gun. Cock the gun by pushing in the operating sleeve. Press down the take-down screw lock, found under the take-down screw, located at the rear of the receiver, and turn the take-down screw to the left until it is free from the receiver. Draw the barrel and forearm directly forward. In cleaning the barrel, retract the bolt by pushing back the operating sleeve and lock it in that position by turning the tip either to the right or left.

THE REMINGTON-U. M. C. AUTO-LOADING RIFLE, MODEL NO. 8

This is a high-power, auto-loading rifle adapted to the .25, .30, .32, and .35-caliber Remington-U. M. C. auto-loading cartridges. The recoil throws the locked-together barrel and breech bolt backward against springs. These springs not only retard and control the backward movement, but also serve to eject the empty shell and to cock and reload the rifle. In these respects it differs from all other auto-loading sporting rifles made in the United States, all others being of the "blow-back" type, the bolt only moving to the rear, its movement being retarded by a weight and springs until the bullet has left the barrel. The Remington-U. M. C. principle is without doubt the best, and it can be used with ammunition having a higher breech pressure than the other type, but the action requires more parts and is slightly more complicated. We thus see this rifle using cartridges which will perform well at long range, whereas the other types use cartridges which will do effective work only at short ranges.



Remington — U. M. C. auto-loading rifle



Remington — U. M. C. auto-loading rifle — premier grade

The mechanical operation of this rifle is best described in six stages:

First stage. At the moment of firing. The hammer has struck the firing pin, driving it forward, exploding the primer, and firing the cartridge. The bolt carrier is locked to the rear of the barrel by the turned position of the breech bolt, there being two locking lugs at the head of the breech bolt similar to the lugs on the Mauser type of rifle. This locked position of the bolt and barrel locks the cartridge in the chamber — all gas pressure is held in — all drive of the explosion is behind the bullet.

Second stage. The cartridge having been fired, the recoil instantly develops. The barrel and bolt carrier, locked together, start rearward, bringing with them the fired shell. The barrel slides rearward through the barrel jacket — the steel casing outside the barrel proper to which the sights are affixed. The rearward rush of barrel and bolt carrier compresses the heavy recoil and lighter action springs, pushing the hammer backward. Towards the completion of the recoil motion the resistance of the buffer spring is encountered. This spring slows down the further rearward motion of the barrel and bolt carrier.

Third stage. At the instant of completing the rearward movement. The recoil and action springs are fully compressed. A projecting latch on the side of the frame, called the "bolt-carrier latch," is allowed at this point to spring into a notch, locking the bolt in its rearward position. The hammer, pushed back to full rear position, is thrown into the safety notch. The trigger is held as if by pressure of the finger when pulled to fire. It will be necessary to release this pressure and allow the trigger to engage with the hammer by the front notch before the next shot can be fired. Each shot, therefore, is under complete control of the trigger finger.

Fourth stage. The instant the recoil is spent, the recoil spring begins to draw the barrel forward in its jacket. The barrel and bolt carrier start forward. The bolt carrier moves but a little distance, as it is held from going completely forward by the bolt carrier latch engaging a notch in the bolt carrier. The barrel, relieved from the bolt carrier, continues its forward movement, revolving the breech bolt proper and thus unlocking itself from it. The empty shell is held in position by the extractor until the forward motion of the barrel withdraws the shell entirely from the chamber, when the ejector, held against the base of the shell by the ejector spring, is allowed to throw the fired shell up and entirely clear of the rifle.

Fifth stage. The recoil spring has carried the barrel forward to

its full forward rest position. The top cartridge in the magazine has been forced upward by the magazine spring. The barrel extension has forced down the barrel lock, which in turn has pressed upward on the forward end of the bolt carrier latch, withdrawing it from the notch on the bolt carrier, and allowing the bolt carrier to start forward, propelled by the pressure of the action spring. The bolt carrier then pushes the top cartridge in the magazine up an incline on the top of the magazine and breech, starting it forward into the chamber. The hammer is still held in the safety notch, and will not be allowed to spring into the forward notch until the bolt carrier has completed its forward motion to lock the fresh cartridge in the chamber.

Sixth stage. The bolt carrier has now completed its forward movement, forcing the cartridge completely into the chamber. The claw of the extractor has ridden over the head of the shell ready for extracting after firing. The firing pin is in position to be struck by the hammer. The breech bolt carrier has completed its forward motion, rotating the breech bolt so as to turn the locking lugs into their seats in the barrel extension, thus locking the breech bolt to the barrel, and locking the cartridge in the chamber. The trigger is held by the forward notch. The rifle is fully cocked, ready to fire.

If it is desired to make the rifle safe for carrying, etc., the raising of the safety lever on the right side of the receiver will throw the safety rocker on the rear of the trigger, locking it.

DIRECTIONS FOR OPERATING

To load. With the safety thrown down, open the breech by drawing the operating handle back as far as it will go. This will expose the opening or entrance to magazine, which can be filled by inserting one cartridge at a time or the full quantity (5), by use of cartridge clip. Three clips are furnished with each auto-loading rifle.

To load with clip. Drop a clip with its five cartridges in the top of receiver, place the end of the thumb on topmost cartridge near the clip, close up to the head, and press the cartridge down into the magazine, then draw back slightly on the operating handle and let it go forward, which will push a cartridge into the chamber.

To load without clip. If not using clip, press the cartridges into the magazine one at a time until it is full, then draw back slightly on the operating handle and let it go forward, which will force the cartridge from the magazine into the chamber.

To refill the magazine when partly empty. It frequently happens that after firing one or more shots it is desirable to refill the magazine. To do this, draw back the operating handle as far as it will go and press upward on the thumb-piece of magazine indicator located on left hand side of receiver on lower edge, which will hold the bolt open. After filling the magazine, draw back slightly on the operating handle and let it snap forward.

To use a single loader. Drop a cartridge on top of magazine and press down on thumb-piece on left hand side of receiver; or press a cartridge into the magazine, draw back on the operating handle and let it snap forward.

To take down. A single "take down" system permits the Remington-U. M. C. Auto-loading Rifle being taken down and put together



Auto-loading rifle, taken down

easily and quickly. This is especially convenient for carrying and cleaning. With the breech closed, unscrew the swivel and remove the forearm, drawing forward toward the muzzle. This will expose the assembling screw with lever attached which holds the barrel jacket and receiver together. Turn the lever down and unscrew, pull barrel jacket forward and it will separate from the receiver. This take-down is extremely durable and positively will not wear loose if assembling screw is kept tight.



Setting
breech-bolt

To put together. Open the breech. Insert end of barrel extension into receiver and press back until the jacket head enters its seat. Screw

down assembling screw tight. Close breech by pressing down on magazine indicator thumb-piece; at the same time hold operating handle to prevent bolt snapping forward quickly. Now, if lugs on bolt do not enter slot in barrel extension, draw back operating handle about one inch and hold it there; then with a cartridge, screw-driver or other implement, push bolt forward until the lugs on bolt are in position to enter slot in barrel extension. Generally the bolt can be pushed forward with the finger and no implement required.

Note that only when the bolt is in its forward position can the locking lugs on bolt enter the slot in barrel extension.

Care should be taken to see that assembling screw is always kept tight.

Sectional views



Action closed



Action open

I have had almost ten years' experience with this rifle and know it to be most reliable in its action and functioning. In all this time I have known but one accident to occur, the breaking of the recoil spring on a .25 caliber rifle. It can be regarded as perfectly reliable so long as the action is kept reasonably clean and lubricated. It is a good, accurate rifle and can be recommended to any one desiring extreme rapidity of fire as the best of our self-loading rifles. As has been stated, it is the only self-loading rifle that is adapted to cartridges suitable for use at ranges over 200 yards. Of the cartridges adapted to it, the .25 caliber is the most accurate and the most pleasant to fire.

The recoil of the .35 caliber cartridge is rather severe, as the auto-loading feature seems to retard the time of recoil so as to make it felt more.

The rifle is regularly furnished with a 22-inch smokeless steel barrel, and with either straight or pistol-grip stocks. Either rifle or shotgun butt stocks can be furnished, but the shotgun butt is only furnished with a hard rubber butt-plate, which is very apt to become broken or chipped in rough service. The safety lock on the right side of the receiver has a very small projection to operate it. This projection should be enlarged to afford a firm grip for the thumb and forefinger. It would then be capable of much easier and quicker operation, especially with gloved hands, and it could be held away from the receiver slightly so as to operate noiselessly. As made, whenever the safety of the rifle is thrown from safe to ready, there is a decidedly audible click which is liable to alarm game just at the wrong moment. The trigger pull is very good, better than that on any other automatic rifle. The complete rifle weighs about 7½ pounds. Both Lyman and Marble tang, and Lyman receiver sights, can be fitted to the rifle.

REMINGTON-U. M. C. HIGH POWER, SLIDE ACTION SPORTING RIFLE

This is a high-power, big-game rifle which is operated by means of a sliding forearm. It is adapted to the .25, .30, .32, and .35 Remington-U. M. C. auto-loading cartridges, and to the .38-40 and .44-40 W. F. C. cartridges. The rifle is hammerless, side ejecting, and has a solid breech and solid top. A new form of spiral magazine is provided which holds the cartridges end to end, and at the same time absolutely prevents any bullet in the magazine from coming in contact with the primer of the next cartridge ahead. The breech bolt is securely locked by a lug on top and near its head.

The opening movement of the rifle, by pulling the slide to the rear, first starts the breech-block open by a powerful wedge action which easily starts the tightest shells from the chamber, after which the continued backward movement of the slide handle completes the withdrawal of the breech-block to the rear, extracting and ejecting the fired shell, and taking a new cartridge from the magazine and sliding it up in front of the face of the breech-block until it is in the grasp of the extractor, and held against the face of the breech-block. The closing of the rifle by pulling forward the slide handles moves the breech-block forward, forcing the new cartridge into the chamber, and wedges

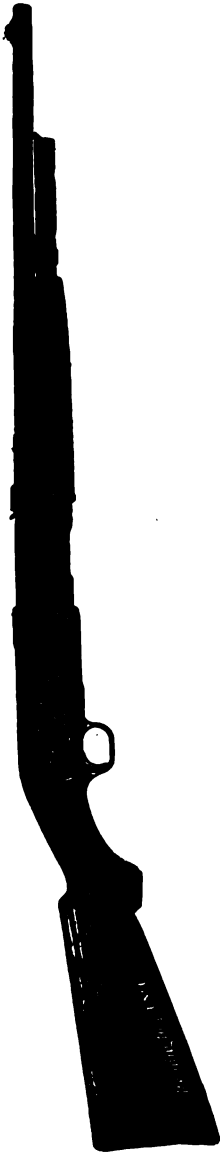

Remington — U. M. C. high-power, slide action, sporting rifle



Remington — U. M. C. high-power, slide action carbine

the block up so that the recoil lug seats into its recess in the top wall of the receiver, and locks the rifle.

Three distinct safety devices prevent the firing pin from exploding

the cartridge in the chamber until the arm is fully locked. The trigger is out of contact with the sear. The sear lock blocks the sear into the firing pin notch. The action bar blocks the firing pin from reaching the primer until the action bar is in its forward position and locked in that position by the action bar lock. Any one of these devices alone would be sufficient to insure safety from premature explosion.

The action is very positive, and much more powerful than one would suppose with a slide-operated arm. It is not at all likely to jam, and it handles the cartridges very easily and quickly. An action operated with the sliding forearm is quite a little quicker than the lever action, being excelled in rapidity of fire only by the automatics. The lines of the rifle are very good, and it is an attractive appearing weapon. It should be particularly good for hunting in thick timber where quick shooting is often necessary. The open rear and bead front sights are very low lying, being much closer to the barrel than in any other rifle on the market. In fact this matter has been very much overdone, and the regular factory sights are so close to the barrel that the glimmer from the top of the barrel often interferes with clear aim. But this is not much of a disadvantage as the riflemen of experience will of course remove these sights and replace them with a tang peep sight, and an ivory bead front sight of regular height. One slight disadvantage is that there is a slight rattle to the slide handle as one walks and this will have to be looked out for when one stalks close to game. The sear is unusually long, and as the rifle comes from the factory the trigger pull is rather creepy, and it is hard to smooth it down. Barring these slight faults the rifle is an excellent one, made of the very best materials, and with good workmanship. The action can be almost completely dismantled without any tools, in which respect it is way ahead of most sporting rifles. It can be strongly recommended to those who fancy a rifle operated with sliding forearm action, particularly to sportsmen who have been used to using the repeating shotguns operated in the same manner.

The regular factory rifle is made with 22-inch smokeless steel barrel, except in .38 and .44 calibers, which have a 22½-inch plain steel barrel. The weight is from 6¾ to 7 pounds. A carbine model is also made with 18½-inch barrel weighing 6½ pounds. The magazine for the .25, .30, .32, and .35 Remington-U. M. C. cartridges holds six shots. The full magazine of the .38 and .44-caliber models holds eleven shots, and the carbine of the same model nine cartridges. The rifle models have very good pistol grip stocks with the grip pushed up close to the trigger

where it belongs, and shotgun butt-plates. Carbines have straight grip stocks.

DIRECTIONS FOR OPERATING

These instructions should be followed step by step. Do not run ahead of instructions.

Loading. Open the action by pushing back the fore-end or slide handle (if the arm is cocked, press in the unlocking plunger on exposed side of breech block) and insert cartridge in chamber. Push the fore-end or slide handle completely forward, turn the arm over, exposing the loading door at the under side of action bar just back of the fore-end. Insert the nose of a cartridge into the forked front end of the loading door, pushing the magazine follower ahead of the bullet. Push the cartridge forward completely into magazine, then let go, when this first cartridge will immediately be driven backward by the magazine spring. The other four cartridges may now be loaded into the magazine.

To load the chamber from the magazine, move the fore-end rearward to the fullest extent, then completely forward. The fore-end is now locked in its forward position until the arm is fired, after which the fore-end may be instantly moved backward and forward, again repeating the action.

To open the breech of the gun without firing, or whenever firing pin is cocked, press the unlocking plunger exposed at right side of breech block while starting the fore-end rearward.

Single loading. Pull slide handle backward to open the breech, insert the cartridge partially into the chamber, then close breech by pulling slide handle completely forward.

To unload the chamber and magazine. Press unlocking plunger while starting the rearward movement of fore-end, complete this rearward movement to eject the cartridge just withdrawn from the chamber. Move the action bar forward to about one-quarter inch of its foremost position, then backward to the limit, ejecting another cartridge; continue this until magazine is empty.

Note.—When emptying the magazine it is convenient to hold the thumb forward of the fore-end so as to strike the magazine ring about one-quarter inch before the forward limit of movement of the slide handle or fore-end is attained; this allows extreme rapidity in unloading.

To make the arm safe when cocked. Push safety at rear of trigger guard towards the right. To fire, move this safety towards the left.

To take down. Grasp the receiver as shown in cut, pressing in ahead of the trigger guard (Cut 1). Unscrew the take-down screw on left side of receiver and pull out until stopped. (This stop pre-

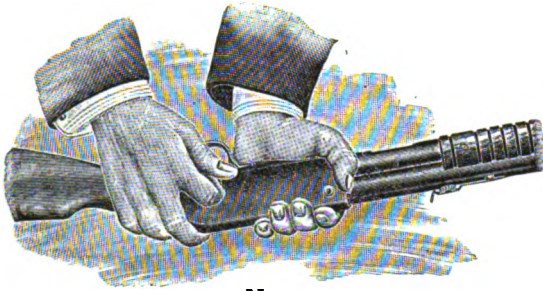

No. 1

vents the screw from being taken clear out of the receiver.) Turn gun on left side so that take-down screw will not drop back in. Grasp barrel firmly just ahead of receiver with one hand; place other hand on stock just back of receiver. (See Cut No. 2.) Pull guard with

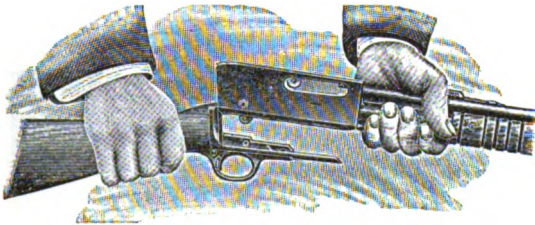

No. 2

stock straight down out of receiver, screw take-down screw back into the receiver. Assemble in reverse order.

To remove breech block from receiver. Cock the arm by moving slide handle backward and forward. Take down the guard and stock from receiver. Press unlocking plunger on right side of breech block and pull slide handle completely backward, then turn *receiver upside down*. Pull breech block backward with one hand and with the other pull slide handle forward to detach action bar from breech block. Then move breech block from receiver.

To reassemble breech block to receiver with receiver upside down, as before, lay breech block (with firing pin cocked) with the recoil shoulder of breech block in well hole in top of receiver. If the firing pin is down so that it projects from the firing pin hole, cock it by

pressing it back with the end of a pencil or similar instrument inserted underneath the action bar lock. Be sure that the recoil shoulder is pushed in to the bottom of the well hole. Holding breech block in this position with thumb, press the rear end of the ejector ex-

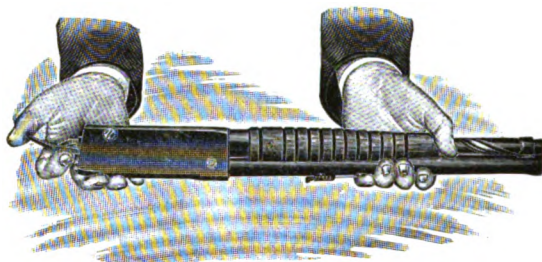

No. 3

posed at the bottom of breech block with index finger. (See cut No. 3.) Force slide handle and action bar backward with other hand to engage action bar with breech block about one-half inch, after which the breech block may be pushed forward about half an inch with the fingers, then pull action bar completely forward.

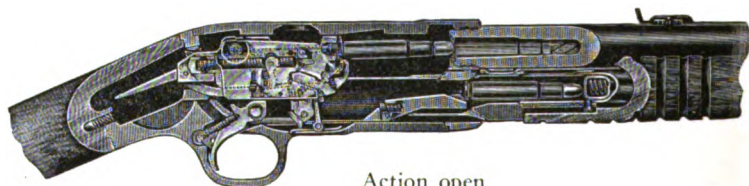

Action open

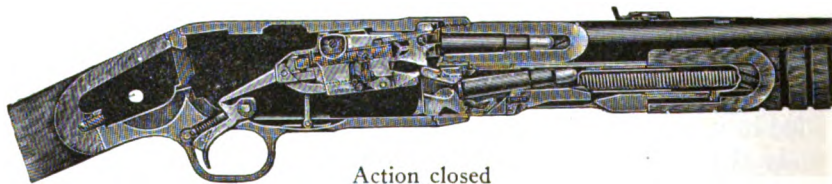

Action closed

Sectional views of high power slide-action rifle

REMINGTON-U. M. C. .22-CALIBER REPEATING RIFLE

This is a slide action rifle which operates with a mechanism very similar to that of the slide action sporting rifle of the same make, except that the magazine is not spiral in form, and the arrangement of sear is much better, allowing of a more perfect trigger pull. It is made

only in .22-caliber rim fire, rifles being chambered for the .22-short cartridge only, for the .22-short, .22-long, or .22-long rifle cartridges interchangeably, or for the .22 Winchester rim fire cartridge only. Rifles are furnished with 22-inch round barrels or 24-inch octagon barrels, and with either straight or pistol grip stocks, and either rifle or shotgun butts. The factory arm is equipped with plain open sights, the



Remington — U. M. C. .22 caliber repeating rifle. Twenty-four-inch octagon barrel, rifle butt



Remington — U. M. C. .22 caliber repeating rifle. Twenty-two-inch round barrel, shotgun butt.

rear sight having a step arrangement for elevation. Lyman or Marble peep sights, and all the models of front sights, can be adjusted on special order.

The rifle is modelled on clean, graceful lines, with a fine sweep from butt to muzzle, and the weight is very well distributed so that the balance is much better than is usually found in American arms. The weight varies from $4\frac{1}{2}$ to $5\frac{1}{2}$ pounds. The action is positive, and the rifle works smoothly and easily with an almost complete freedom from jams. It has been in use for a number of years and has always given perfect satisfaction. It is probably the most popular .22-caliber repeating rifle on the market today. The breech-block can be removed without the use of any tools, and the entire action cleaned; a very necessary matter with a rifle handling outside lubricated, .22-caliber cartridges. Removing the breech-block allows the rifle to be cleaned and examined from the breech, which is also an important feature. The rifle can be taken down for packing in small space. The only criticism that can be made of this arm is that it is a little too small for a full-sized man. It would be better for sportsmen's use if the stock were made full size, and a trifle more weight placed in the barrel. It is an excellent rifle for boys, and also, when made to handle the .22 Winchester rim fire cartridge, for a grouse gun to be used around camp on trips for big game.

DIRECTIONS FOR OPERATING

To load magazine. Press in magazine lever at front end of magazine and withdraw inner tube until loading slot is open; the cartridges can then be dropped into the magazine.

The magazine of the "Standard" grade rifle will hold 15 Short, 12 Long or 11 Long Rifle Cartridges. The magazine of the "Gallery" grade rifle will hold 15 Short Cartridges only. Magazine of the "Target" grade will hold 15 Short, 12 Long or 11 Long Rifle Cartridges. Magazine of No. 12CS holds 9 Remington Special (.22 W. R. F.) Cartridges. When the magazine is full, press down the inner tube until locked in place.

The magazine can be emptied without passing the loaded cartridges through the action by drawing the inner tube entirely out, when the cartridges will drop out of the mouth of the magazine.

To load the gun. When the action is locked, press up on the front end of carrier exposed just in front of the trigger guard while starting the backward movement of the slide handle; move the slide handle

smartly backward and forward, which will carry a cartridge into the chamber and lock the action ready for firing. The act of firing releases the action lock, permitting the operator to reload by working the slide handle.

To take down the gun. Unscrew the assembling screw on the left hand side of the receiver; pull screw out until it strikes the stop pin, which prevents its dropping from the receiver.¹



Rifle taken down

Hold the gun with left side downward to prevent assembling screw from dropping back and pull the stock straight back to separate from the receiver. Cock the hammer before putting gun together.

To remove the breech block. After the gun is taken down, pull the

Sectional views



Action open

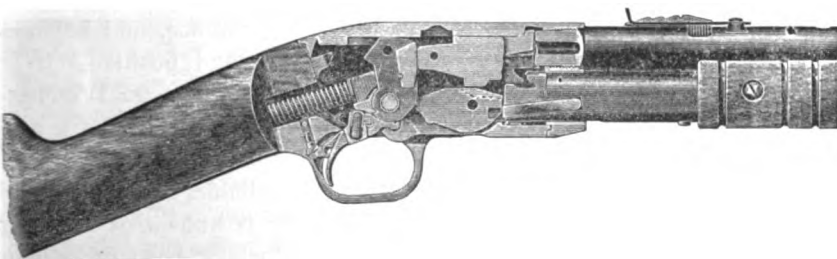

Action closed

¹ This take-down screw is not supposed to be detached from the receiver.

fore-arm back, at the same time pushing in the little button on the bottom of the action bar so that it slides under the edge of the receiver. Hold the breech block back and pull the fore-arm forward and the breech block can be lifted out.

REMINGTON-U. M. C. .22-CALIBER AUTO-LOADING RIFLE

This is a .22-caliber, auto-loading rifle adapted to the .22 Remington auto-loading cartridge, which is almost exactly the same as the .22 Winchester self-loading cartridge. The mechanism of the rifle is almost exactly the same as that of the .22 Winchester automatic rifle, except that the action is operated before the first shot, to throw the first cartridge into the chamber, by means of a knob on the bolt instead of by an operating sleeve in front of the forearm. Like the Winchester, the magazine is in the butt stock, and it is filled in much the same manner by drawing the magazine follower out through the butt plate. The take-down arrangement is a little different, the barrel and forearm being unscrewed entirely from the receiver by means of an interrupted thread on the breech of the barrel. The magazine holds 15 cartridges.

The rifle is operated by the recoil which forces the breech-block to the rear, extracting and ejecting the fired cartridge, and compressing the main-spring. The action spring then forces the breech-block forward, inserting the cartridge in the chamber and closing the action.

The rifle is an excellent one of its type, being full sized, of fine lines, appearance, and balance, and the mechanism is sure and positive. It is subject to the same criticism as the .22 Winchester automatic rifle; namely, that it handles a cartridge loaded only with smokeless powder, and while this cartridge is reliable, accurate, and pleasant to handle, no way is known of cleaning the bore when this cartridge has been fired in it which will insure against ultimate ruin from rust. The barrel will gradually become pitted, and after

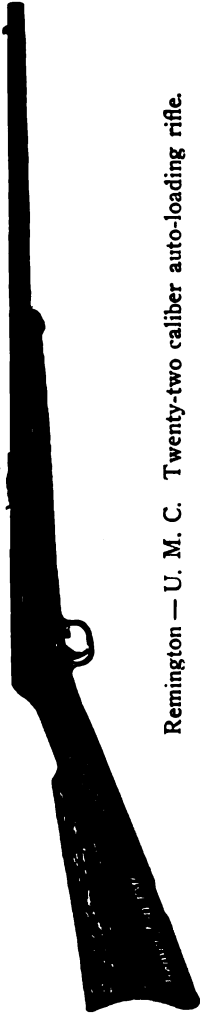

Remington — U. M. C. Twenty-two caliber auto-loading rifle.

extended use the accuracy will deteriorate until it becomes necessary to purchase a new barrel. It would seem that it should be possible to load these cartridges with Lesmok or semi-smokeless powder and avoid this trouble.

The rifle has a 22-inch, round barrel, cut with 16-inch twist, and a straight grip stock. Pistol grip stocks cannot be furnished. The butt plate is of steel, a compromise between rifle and shotgun shape. Plain open sights, with step device for elevating the rear sight. Lyman and Marble peep sights can be attached to the tang. The weight is 5 $\frac{3}{4}$ pounds, and the trigger pull very good for an auto-loading rifle.

DIRECTIONS FOR OPERATING

To take down. Grasp the receiver and barrel in the right and left hands respectively, and with the right thumb, pull back the take-down



Rifle taken down

button and unscrew the barrel from the receiver by a quarter-turn. The magazine may be left fully or partly loaded if desired.

To remove breech block. Remove assembling screw in left side near end of receiver. Move breech block rearward about halfway and pull receiver forward to separate from trigger plate. Move breech block fully rearward, insert small end of assembling screw into hole in bottom of breech block and release the block so the action spring is retained by the screw. The complete breech block and ejector may then be removed from the receiver.

To put rifle together. With the receiver right side up and in the right hand and the barrel in the left hand, insert the barrel into the receiver so that forearm projects at left side of receiver. Turn forearm down as far as it will go.

To load. Push down magazine lock-pin which extends upward into hollow near the toe of butt plate. Pull out magazine tube until loading hole is uncovered. Load magazine with 15 .22 Remington Auto-loading cartridges, being very careful to put the cartridges in so that

their bullets will be toward the muzzle of the gun. Close and lock magazine. Pull operating handle back as far as it will go and allow it to snap forward. The rifle is now loaded, cocked and ready for action.

To unload. Pull magazine tube all the way out of magazine, pour the cartridges out and replace the magazine tube. With the safety on, pull operating handle back and allow it to snap forward *twice* to eject the cartridge in the chamber and the one in the action.

To operate safety. The safety is the button in the trigger guard just in front of the trigger. Pushing this button to the right locks the trigger, making the arm safe. Pushing to the left throws off the safety and the rifle is ready to fire. When the safety is on and the rifle is locked, the letter "S" appears to the left of the button, showing that the rifle is safe.

Sectional views



Action open

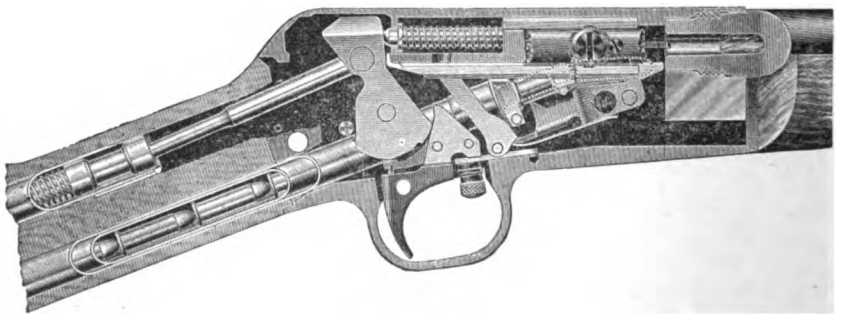

Action closed

SAVAGE REPEATING RIFLE, MODEL 1899

This is a box-magazine, lever-action rifle. Inside the magazine recess of the receiver is a circular brass magazine which holds the cartridges separated in a circular position from each other so that they are not touching. The cartridges are pressed into the magazine one at a time, and when filled the magazine revolves, presenting each cartridge in turn in front of the breech bolt as the action is operated. The rifle is operated by a finger lever which withdraws the breech bolt, extracting and ejecting the fired shell to the right. As the lever is closed, it carries the breech bolt forward, forcing the topmost cartridge from the magazine into the chamber. During the closing of the bolt the sear engages the hammer or cocking piece, and as the rifle is closed the mainspring is compressed, making the rifle ready to fire. Just as the breech bolt is closed, its rear end rises to abutt against the top of the receiver just in rear of the cartridge opening, and the breech bolt is thus wedged between the rear of the receiver opening and the rear of the chamber, and thus supported against the recoil. An examination of the sectional cuts of the mechanism will make this plain.



Fig. 9

Savage repeating rifle, Model 1899, with Lyman No. $3\frac{1}{2}$ rear sight and 22-inch barrel

The number of cartridges in the magazine is always indicated by numerals which appear in a recess on the left side of the receiver. An indicator on top of the receiver shows whether the rifle is cocked or not; the indicator, in the shape of a small pin, projecting above the surface of the receiver when the rifle is cocked, and can be both seen and felt. The safety is just in rear of the trigger guard, between the guard proper and the loop of the lever, and is put to safe by pressing it forward, when it both blocks the trigger and locks the finger lever against opening. The action can be closed without cocking the rifle by holding back on the trigger when closing the lever, when the mainspring will not be compressed. To operate the rifle as a single loader, holding the magazine in reserve, simply press the single cartridge down on the topmost cartridge in the magazine and close the lever.

The mechanism is extremely simple and very reliable. I have never heard of a jam with a Savage rifle except when some foreign substance happened to get into the magazine. The action is a very strong one, considering that the breech bolt is supported against the explosion at the rear, and it has successfully withstood the 50,000 pounds breech pressure exerted by the .250-3000 Savage cartridge. At this pressure, however, there is a little spring to the bolt, and cartridges fired with the full charge have the shells so stretched that they cannot be successfully re-loaded.

The rifle is made in both solid frame and take-down styles, the former being always preferable on account of its much better accuracy. It is also made in a number of different styles with various lengths and weights of barrels, from 25 inches to the 20-inch carbine, and in featherweight models. The balance of the rifle is very good indeed, particularly if made with a 22-inch barrel, pistol grip, and shotgun butt. The design of the stock is very good, but is about half an inch too short to fit the average man correctly. The drop at the comb and heel are just about right.

The best rear sight for the Savage rifle is the Lyman No. 30½ tang peep sight with both elevation and windage adjustments. With a rifle having a 22-inch barrel, one point change on the elevation scale will move the point of impact 6.15 inches on the target at 100 yards, and proportionately at all other ranges. One point change on the wind-gauge scale will similarly move the point of impact 2.46 inches at 100 yards. This sight can be screwed right on the rifle by any one, screw holes being already tapped on the upper tang of the receiver for it.

The Savage Model 1899 rifle is made for the following cartridges :

- .22 Savage high power.
- .25-35 Winchester center fire.
- .250-3000 Savage high power.
- .30-30 Winchester center fire.
- .303 Savage high power.
- .32-40 high and low power.
- .38-55 high and low power.

All barrels are made of the same special smokeless steel that is used in United States Government arms. The Savage barrels made during the past nine years at least have been most excellent, the three which I possess at the present time showing excellent finish, calibration, and straightness, and giving fine accuracy. I consider this rifle an exceedingly reliable and durable arm. I have seen a number of them in the mountain wilderness of northern British Columbia which have been

in use for over fifteen years, subjected to the hardest kind of usage without developing a single defect. The only fault ever found with this action, to my knowledge, is that if anything falls into the magazine, like pine needles or small twigs, it is almost impossible to get it out without dismounting the magazine, and that is a very difficult operation to perform in the woods. On the other hand, the action shuts up so tightly when closed that the chance of anything getting in is very remote. The rifle lends itself well to extreme rapidity of fire, being almost equal to the Model 1886 Winchester in this respect, as the lever works very easily and has a very short throw. The stock is secured to the receiver by a long, heavy screw which passes through the center of the grip of the stock, being screwed into the receiver from a hole through the stock under the butt plate. This screw greatly strengthens the stock at the grip, its weakest point, and considerably adds to the ability of the rifle to withstand the hard knocks of real wilderness work.

SAVAGE RIFLE, Model 1899.

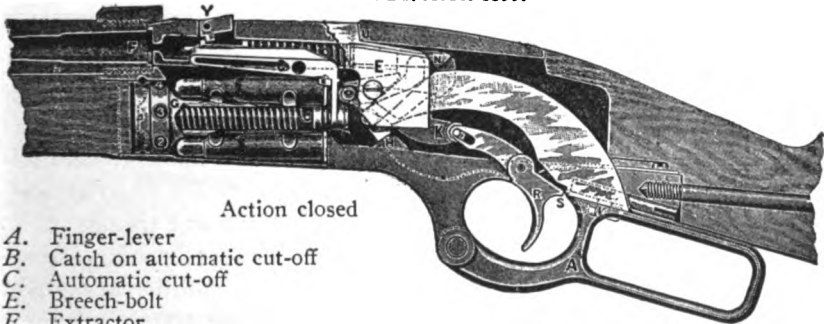

Action closed

- | | |
|---|------------------------------|
| A. Finger-lever | P. Sear screw |
| B. Catch on automatic cut-off | R. Trigger |
| C. Automatic cut-off | S. Trigger safety projection |
| E. Breech-bolt | U. Recoil shoulder |
| F. Extractor | V. Trigger and lever lock |
| G. Magazine carrier | Y. Indicator |
| H. Projection on receiver for finger-lever. | |
| K. Sear | |
| N. Hammer | |
| O. Main spring | |

Rifle Model 1899 is manufactured with the new hammer indicator.

When the hammer is at full cock the indicator Y projects above the breech-bolt; when the rifle is fired or the hammer is down, the indicator is flush with the top of the breech-bolt.

To dismount the rifle. Remove the butt plate, unscrew the butt stock screw with a long screw-driver, preferably held in a brace, and remove the butt stock by pulling it to the rear. Open the finger lever to its fullest extent. Remove the trigger spring screw, trigger spring, bolt-stop screw, and bolt stop. Remove the finger lever bushing screw, and push out the finger lever bushing. Displace finger lever at pivot joint. Withdraw the breech bolt. Remove trigger pin, punching the same

DESCRIPTION OF SYSTEM. Model 1899.

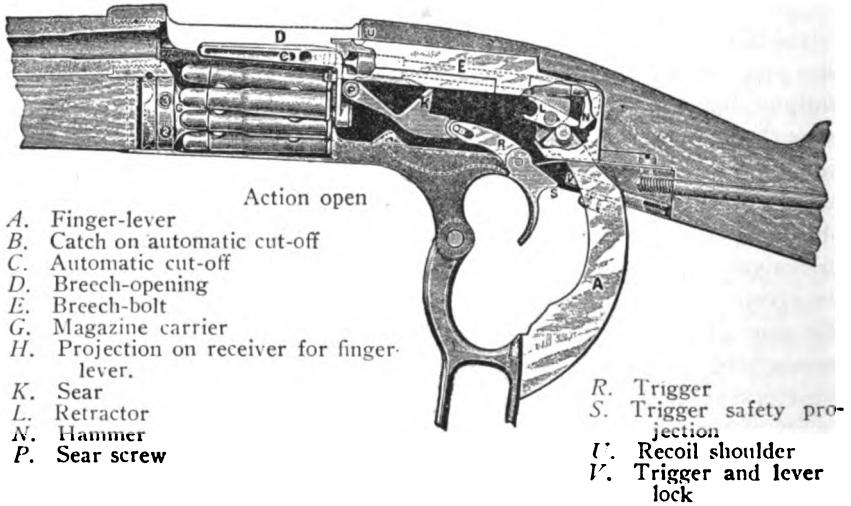

out from left to right; remove the sear screw, and take out the sear and trigger. Take out the finger lever, remove the trigger and lever lock. Remove the forearm screw and forearm, or else remove the barrel in a take-down rifle. Unscrew the magazine spindle screw and remove it free from the receiver. Remove the magazine carrier and magazine spindle, and then remove automatic cut-off and spring.

To dismount the breech-bolt. Remove the hammer bushing screw, pull out the hammer with the mainspring, punch out the firing pin securing pin, unscrew the firing pin, and remove the retractor screw. Punch out the extractor pin from top to bottom; the extractor will then be free. To separate the magazine spindle and the magazine carrier, pull the magazine spindle out of the magazine carrier; the magazine spring can then be removed.

To assemble the rifle. Replace the parts in the reverse order from that given for dismounting, keeping in mind the following points: Replace the automatic cut-off and spring. Replace the magazine carrier, magazine spindle, and magazine spring together, and give tension to magazine carrier by turning the spindle with a screw-driver from right to left. Insert the spindle screw. Do not give too high a tension to magazine spring, as it will make the loading of cartridges into the magazine unnecessarily hard. In replacing the retractor in the breech bolt be sure that the retractor is in retracting position (as shown in cut of action open) before replacing hammer and bolt.

THE .22-CALIBER SAVAGE REPEATING RIFLE, MODEL 1914

This is a .22-caliber repeating rifle of the trombone or sliding forearm type, having a tubular magazine, hammerless action, with solid breech, and top and with side ejection. All the moving parts are enclosed in the receiver. The safety is of the shotgun type and is located on top of the tang, immediately in front of the grip. The rifle can be taken down by removing the assembling screw on the right side of the receiver. It handles the .22-short, .22-long, and .22-long rifle cartridges indiscriminately without change of mechanism, but the .22-long rifle is the cartridge which should always be used, as the use of the .22-short will sooner or later result in the burning out of the chamber and consequently the ruination of the barrel, and the .22-long cartridge is an inferior one.

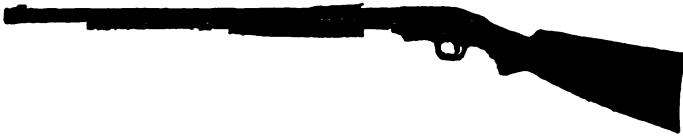

The .22-caliber Savage repeating rifle, Model 1914.



Rifle taken down
for convenience in
cleaning or carrying



This rifle is particularly pleasing in its outline. It has a most excellent pistol grip stock, which is full sized, a matter often overlooked in the .22-caliber repeating rifles. The pistol grip is well curved and pushed up close to the trigger guard, as it should be. The shotgun safety can be operated much faster than the trigger guard type usually seen on these rifles, and is always in sight, showing clearly at all times whether the rifle is safe or ready. The action slide handle is long and well shaped, like a regular forearm. The action is safe, sure, and positive. Altogether this is one of the very best .22-caliber rifles on the market, and can be particularly recommended to the rifleman who wishes a light, .22-caliber repeater but dislikes the other models because

of the fact that they are made in a size suitable only for boys. Lyman and Marble rear peep sights can be fitted to the tang, and all the regular front sights can also be placed on the rifle.

To load the rifle. Turn the thumb piece at the forward end of the tubular magazine one quarter turn to the right and draw out the follower tube until the loading window is open. Drop cartridges, bullet ends up, through the loading window down into the magazine until filled. Then push the follower tube home into the magazine, and lock the thumb piece by giving it a quarter turn to the left. After filling the magazine, draw the slide handle back fully to the rear, and push it quickly forward again. The rifle is now loaded and cocked, and may be fired by pressing the trigger. To reload, repeat the operation of pulling back the action slide and pushing it forward quickly again. When the rifle is loaded and cocked, if the rifleman does not wish to fire immediately, but wants to have it in a perfectly safe condition yet ready for instant use, the safety must be drawn back with the thumb until the word "SAFE" appears. In this condition the firing mechanism is locked and the rifle may be carried without the least danger. Upon pushing forward the safety, the arm may be fired at once by simply pulling the trigger. Besides the safety, the rifle also has a hammer indicator, a small pin in the center of the safety, which shows the position of the hammer. When this protrudes ("sticks up"), the hammer is down and the rifle uncocked. When it is flush with the safety, the hammer is cocked.

To unload the rifle. Remove the loaded cartridge from the barrel by releasing (pressing up) the action slide lock and bringing back the slide handle. Leave the slide handle back and then pull the magazine follower tube entirely out of the magazine. By turning the rifle muzzle down the cartridges will drop out. This leaves a cartridge in the carrier. Push the action slide fully forward, press up on the action slide lock, and pull the slide handle back again. The rifle is now empty.

To put the rifle together. Remove the assembling screw on the right side of the receiver. Push back the hammer until cocked. Press up the action slide lock (at the forward end of the receiver where the magazine tube joins it) and push back the slide handle until rear end of action slide becomes flush with the rear end of receiver. Engage rounded projection at front end of butt half of the receiver with the rounded recess on the left side of the barrel portion of the receiver. Press the barrel receiver and butt receiver together until the lug on the top and rear of the barrel receiver enters and locks in the notch in the

top of the butt receiver just in front of the safety. Screw the assembling screw home through the hole in the barrel receiver into the stock receiver. Hold trigger back and push slide handle forward so as to leave the rifle uncocked. To take down, simply reverse the order of putting the rifle together.

To clean the rifle. Take the rifle down and open the action half-way by pressing up on the action slide lock and pushing back the slide handle. Pick the breech bolt off its stud on the action slide with the fingers. The barrel can now be cleaned and inspected from the breech, and all parts of the action can be wiped off and oiled. The action should be kept lightly oiled and free from bullet lubricant.

THE SAVAGE HIGH-POWER, BOLT-ACTION RIFLE

This is the latest rifle made in the United States at the time of going to press of this work. It is constructed on the Mauser system, and



Fig. 10

The Savage high-power, bolt-action rifle

is adapted to the .250-3000 Savage high-power cartridge. The mechanism is almost identical to that of the Mauser. The right side of the bridge of the receiver is divided, and the bolt handle fits down between the two portions of the bridge, thus forming a safety lug in lieu of the ordinary safety lug on the rear of the bolt barrel in Mauser rifles. The two locking lugs at the head of the bolt are approximately the same size as those on the Model 1903 rifle, and perfectly support the cartridge against the force of the explosion. The cartridge is so well supported that there is no stretching of fired shells such as occurs in the Model 1899 Savage action for this cartridge, and consequently shells fired with the full charge can be reloaded without resizing except at the neck. The sear acts as the bolt stop. To remove the bolt from the rifle, pull back on the trigger as the bolt is pulled to the rear. The remainder of the dismounting is done in exactly the same manner as with the U. S. Model 1903 rifle. The safety is on top of the tang and operates in exactly the same manner as the safety on a double hammerless shotgun. This is an enormous advantage for a sporting arm, as the

rifle can be gotten ready for firing much faster than with the ordinary bolt action safety on the sleeve. The barrel is 22 inches long, beautifully tapered, and in all respects the same as the barrel of this caliber on the Model 1899 rifle. The stock measures $13\frac{1}{2}$ inches long, drop at comb $1\frac{7}{8}$ inches, drop at heel 3 inches. These are the measurements which comes nearest to fitting the average man. It is the best fitting factory stock made on any American rifle, and has an excellent pistol grip stock of exactly the right shape and location. The aluminum butt plate is of the correct shape, with just enough hollow to cause it to stick tightly to the shoulder when the bolt is worked in rapid fire. It is sharply checked to prevent slipping on the shoulder, and has a large trap door in it with recess in the butt stock, so that a field cleaner, etc., can be kept in the butt. It is undoubtedly the best butt plate made in America, and I predict that a large number of them will be sold to be placed on other made to order stocks. The sights ordinarily furnished are a bright metal bead front sight, and the ordinary step, open rear sight. The rear sight, however, has screw adjustment for windage, a flat top, and an excellent "U" shaped notch, making it very satisfactory for those who prefer open sights. The cocking piece on the rear end of the firing pin is so shaped that it should be an easy matter to fit a Lyman peep sight to it. The peep sight so placed should be in exactly the right location for most effective work. When the rifle is cocked the sight will be back near the eye where it should be in aiming, but as the rifle is fired the cocking piece will fly forward, taking the sight with it, and thus moving the sight forward so that it cannot strike the eye in recoil. The balance of the rifle is absolutely perfect. The arm weighs just seven pounds, is very handy to carry, comes up perfectly, and will prove a quick and handy arm. Fortunately this rifle is made in solid frame, and the accuracy should be superior to that of the Model 1899 Savage using the same cartridge. An accuracy test of ten groups of ten shots each, fired at 100 yards, rest, open sights, gave an average group measure of 3.12 inches. This test would undoubtedly have shown a better average had the rifle been equipped with peep sights, as my error of aim is considerably greater with open than with peep sights. I should say that with peep sights I would be able to get groups at 100 yards averaging at least 2.50 inches, which is as close as I can get with the Model 1903 rifle and the best ammunition. I predict that this little rifle will quickly become easily the most popular rifle in America for medium game shooting.

MARLIN REPEATING RIFLES, MODELS 1893, 1894, AND 1895

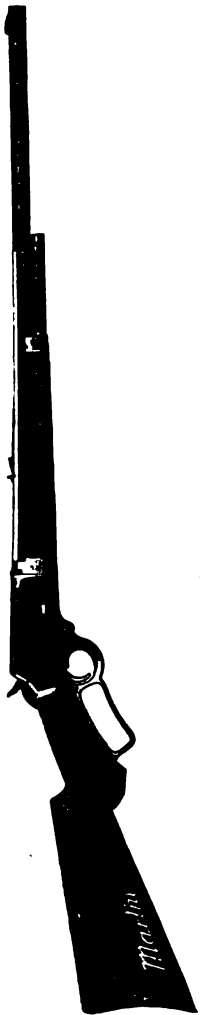

Marlin repeating rifle, Model 1894, with pistol grip stock

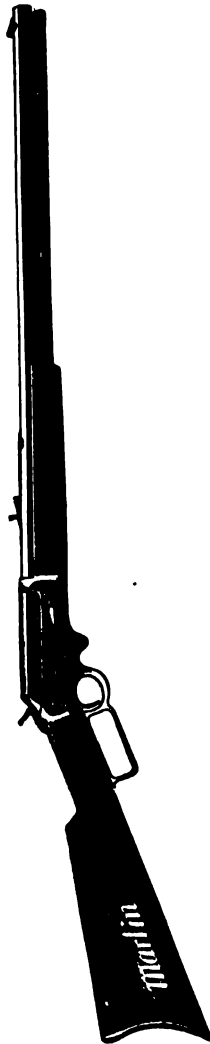

Marlin repeating rifle, Model 1893

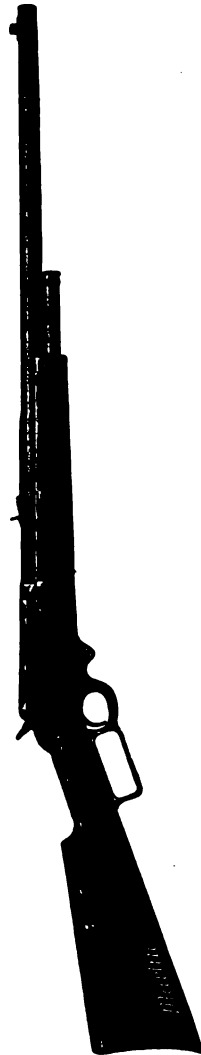

Marlin repeating rifle, Model 1895, caliber .33 W. C. F.

The action of all three of these rifles is practically the same, the models being adapted to different classes of cartridges. The Model 1893 handles and .25-36 Marlin, the .30-30 Winchester, .32-40, .32 Winchester special, and .38-55 cartridges. The Model 1894 handles the .25-20 repeater, .32-20, .38-40, and .44-40 cartridges. The Model

1895 handles the .38-56-255, .40-65-260, .40-70-330, .40-82-260, .45-70, and 45-90 black powder cartridges, and the .33 W. C. F. high power cartridge. These rifles are all tubular magazine, lever-action repeaters, and differ from the Winchester repeating rifles principally in having a solid top to the receiver, and in ejecting the fired shells to the right side. The locking bolt does not project so that it can be seen, but enters a cut on the under side of the breech bolt near the rear of the latter, and supports about half of it. It slides in vertical grooves cut in the inside walls of the receiver, and gives the breech bolt very good support. The safety arrangement differs considerably from the usual arrangement. The firing pin is cut completely in two towards the rear end, and when the action is closed and locked these two pieces are brought up by the locking bolt into a direct line and practically form one piece. The slightest movement of the finger lever draws back the firing pin, the locking bolt is lowered, and the front end of the rear portion of the firing pin drops down in the slot in the breech bolt where it is held back positively, and it is impossible to drive it forward until the breech bolt is closed and the locking bolt has risen to the fully locked position.

It is understood that the manufacture of these models has ceased, due to the factory being given over entirely to the manufacture of war material, and it is probable that it will never be resumed, a more modern rifle probably taking its place. However, as there are a great number of these rifles in the hands of sportsmen throughout the country, where they are giving excellent service, it has been thought best to include a description of it, and particularly to give directions as to its dismounting and assembling before these directions are entirely out of print.

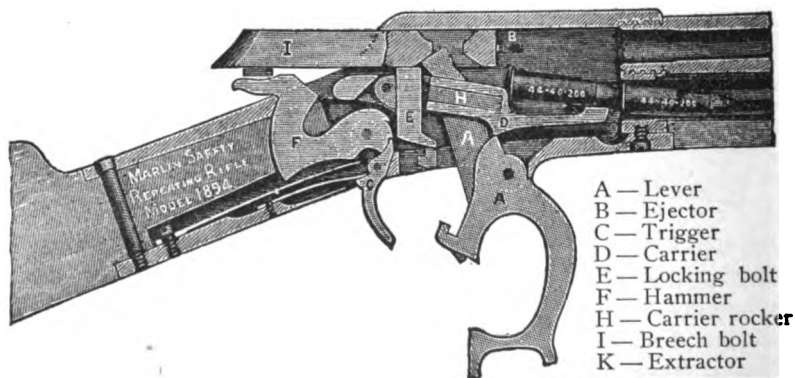

Cut showing section of rifle — action open

To assemble the arm. If the loading spring cover and carrier block are out, put these in first. Slide in the locking bolt, put on the trigger plate and screw in the trigger plate screw. Replace the hammer and screw in the hammer screw. Place ejector in its slot, *being sure that the flat spring side is down in the slot* (some shooters place it up-side down). Slide in the breech bolt about two thirds of the way and put in the lever, being careful to see that it fits up into the breech bolt as illustrated in the cuts. Screw in the lever screw. Swing the main spring into position and replace the buttstock.

To remove the magazine. It is necessary merely to take out the magazine tube stud screw and the two forearm tip screws. The entire magazine forearm tip and forearm can then be removed.

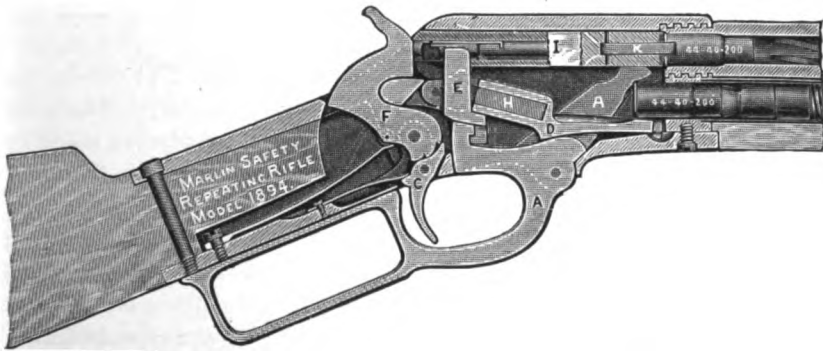

Cut showing section of rifle — action closed

To dismantle the arm. Take out the tang screw and remove the buttstock. Swing the main spring to one side, thus removing all pressure from the hammer screw; take out the hammer screw and remove the hammer. Remove the lever screw and lever; the breech bolt can then be drawn out. Take out the trigger plate screw at the front end of the trigger plate and the screw on left side of receiver, when the trigger plate and locking bolt may be removed. As all of these screws have practically the same size head, it will be observed that a single screwdriver is the only tool necessary to dismantle the rifle conveniently. If desired, the carrier and likewise the loading spring cover may be removed, as the screws holding these are on the right side of the action.

To take apart the breech bolt. Drive out the extractor pin; the extractor can then be removed. Drive out the pin holding the rear part of the firing pin, which can then be removed; also drive out the front

firing-pin pin; this part of the firing pin and the firing-pin spring can then be removed. In driving out these pins, drive from the bottom of the breech bolt. In driving in, drive from the top.

MARLIN MODEL 1897 RIFLE

This is a lever-action, 22-caliber rifle, adapted to the .22-long rifle

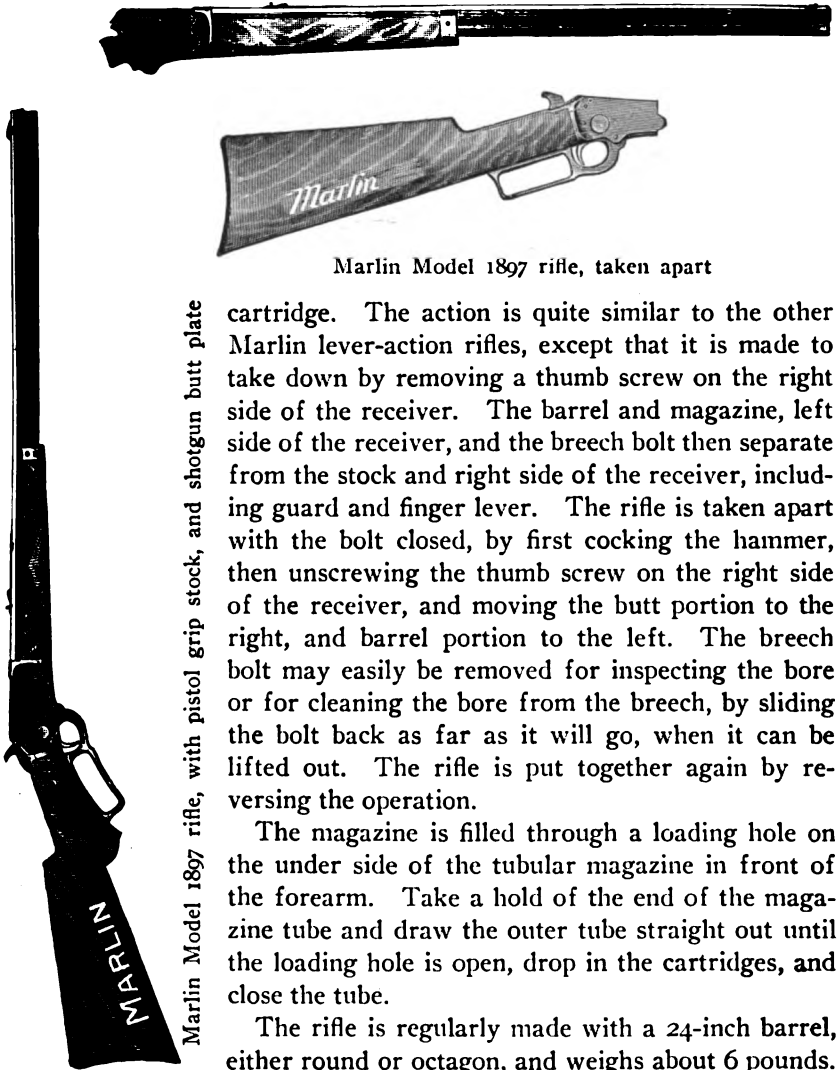

Marlin Model 1897 rifle, taken apart

cartridge. The action is quite similar to the other Marlin lever-action rifles, except that it is made to take down by removing a thumb screw on the right side of the receiver. The barrel and magazine, left side of the receiver, and the breech bolt then separate from the stock and right side of the receiver, including guard and finger lever. The rifle is taken apart with the bolt closed, by first cocking the hammer, then unscrewing the thumb screw on the right side of the receiver, and moving the butt portion to the right, and barrel portion to the left. The breech bolt may easily be removed for inspecting the bore or for cleaning the bore from the breech, by sliding the bolt back as far as it will go, when it can be lifted out. The rifle is put together again by reversing the operation.

The magazine is filled through a loading hole on the under side of the tubular magazine in front of the forearm. Take a hold of the end of the magazine tube and draw the outer tube straight out until the loading hole is open, drop in the cartridges, and close the tube.

The rifle is regularly made with a 24-inch barrel, either round or octagon, and weighs about 6 pounds.

It can be had with either straight or pistol grip stocks. Lyman sights can be applied to the tang as in other models of lever-action rifles.

This rifle has for a number of years been the favorite .22-caliber repeater with riflemen who wish such an arm to be full size, and also to have a lever action so that when they come to change to their larger rifles there will not be such a difference in manipulation. It is an excellent arm for the sportsman who owns a high-power, lever-action rifle, and desires to get cheap practice between hunting trips. The action is not quite as positive as some of the more modern .22-caliber repeaters, and jams occasionally occur. No grave consequences, however, attend a jam with a .22-caliber rifle, and many sportsmen are only too willing to overlook this fault in order to obtain a man-sized, lever-action, .22-caliber repeater. The arm balances and handles well, and is a beautiful appearing little arm. It may be used with the .22-short and .22-long cartridges, as well as the .22-long rifle, but the continued use of the first two cartridges will ultimately ruin the chamber of the rifle, and there is absolutely no excuse for using them as they are less accurate and less powerful.

THE STEVENS IDEAL RIFLE

This is a single shot rifle with a falling block action somewhat similar to the Winchester single shot. The action is operated by means of the finger lever. When the finger lever is thrown down, the breech-block first slides down a short distance and then rocks to the rear, exposing the chamber for loading or cleaning. During the latter portion of the opening movement of the breech-block it bears upon the extractor,

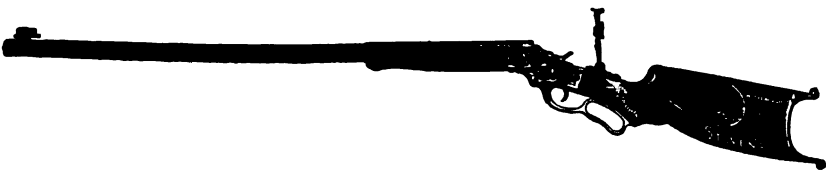

The Stevens Ideal rifle. "Walnut Hill" Model

forcing the latter to the rear, and withdrawing the shell about one-fourth inch from the chamber so that it can easily be withdrawn by hand. The first opening movement withdraws the firing pin, which is held back until the rifle is closed. The closing movement of the finger lever rocks the breech-block forward, pressing the cartridge into place, then slides the block slightly upward into its slot in the receiver, and at

the same time brings the hammer to half cock. To make the rifle ready for firing it is then necessary to cock the hammer.

The Ideal rifle is adapted to the following cartridges: .22-short, .22-long rifle, and .22 Winchester rim fire, .25 Stevens rim fire, .22-15-60 Stevens center fire, .25-20, .25-21 Stevens, .25-25 Stevens, .28-30-120 Stevens, .32-20, .32-40, and .38-55. It is made only with the ordinary steel barrels, and for black or low-pressure cartridges. All rifles have the take-down feature, the barrel screwing into the receiver in the regular manner, but the thread being eased up so that it can readily be screwed in or unscrewed by hand. A taper pin screws into the bottom of the receiver under the barrel and retains the barrel tightly screwed up into place. Barrels are almost all of the octagonal or half octagonal shape, and may be had in several weights, so as to make the complete rifle weigh from 7 to 11 pounds.

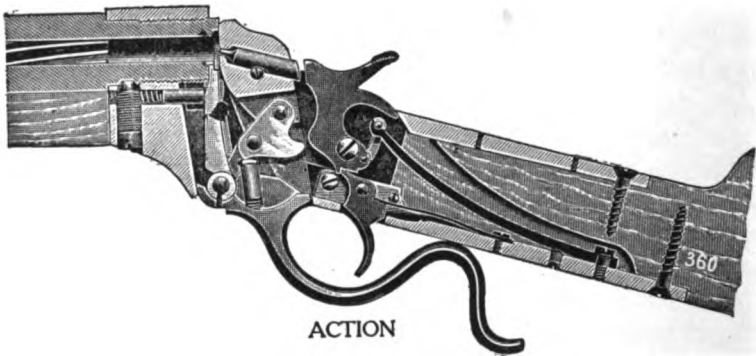

S. S.

Breech mechanism of the Stevens Ideal rifle. Breech closed

The manufacture of this rifle was stopped several years ago at the start of the Great War, when the plant of the J. Stevens Arms and Tool Company was given over entirely to the production of war munitions. It is not known whether it will ever be placed on the market again or not. It was quite a popular rifle, particularly among Schuetzen riflemen, and among the various small bore clubs. The rifle was rather roughly manufactured, the various parts were not strictly interchangeable, and the best of materials were not always used, although the rifle always had plenty of safety margin for the cartridges it was designed to handle. But the barrels were almost always superbly accurate, and many fine scores have been made with Stevens rifles. This was par-

ticularly true of rifles chambered for the .22-long rifle cartridge. Many of these rifles are still in use among the various small-bore clubs in the country, doing excellent work, and showing accuracy inferior to none except Pope barrels. The design of the rifle was fine, and it is to be regretted that it was not better made, better materials used, and that its manufacture was discontinued.

THE ROSS, MODEL 10, STRAIGHT PULL SPORTING RIFLE

This is a Canadian rifle, manufactured by the Ross Rifle Company of Quebec. It is largely advertised and sold in the United States. It is a bolt action rifle, but differs considerably from the ordinary Mauser type in that in operating it it is only necessary to pull the bolt straight to the rear, no turning up or down of the bolt handle being necessary. The Ross bolt consists of two distinct portions: the bolt itself; and the bolt sleeve, carrying the bolt handle and the safety bolt. The bolt is a steel cylinder about $4\frac{1}{2}$ inches long. On the bolt head are the two locking lugs in the shape of interrupted screw threads. These lugs are $\frac{3}{16}$ -inch deep — from the top of the lug down to the bolt. Into the lugs are cut portions of an interrupted thread, $\frac{3}{32}$ -inch deep. The bottom lug, when the bolt is in its locked position, has three cuts in it, making four segments of the thread to lock into the receiver. The opposite lug has two cuts, making three of the thread segments. In the receiver walls are cut corresponding sections of threads into which these bolt head sections lock firmly when the bolt is revolved. The main locking shoulders of the lugs turn down against shoulders in the receiver, forming an additional lock similar to the ordinary system of bolt locking. Along the rear three inches of the bolt spindle are cut two helicoid ribs, terminating at the rear in sections of an interrupted screw. These ribs, working in corresponding grooves in the bolt sleeve, form the means by which the Ross bolt is revolved. Between the two locking lugs of the bolt is cut a gas escape hole, through which gas may escape in the case of a punctured primer.



Fig. 11

The Ross .280 sporting rifle, Model 10

The bolt sleeve is a hollow cylinder carrying the extractor, the bolt handle, and at its rear end the safety bolt. It is about $5\frac{1}{2}$ inches long. Along either side run the guide grooves which engage ribs in the receiver and make the sleeve run perfectly true and smooth. These ribs prevent the sleeve from turning. Inside the sleeve works the bolt proper, the spiral — helicoid — ribs on the bolt spindle engaging in corresponding grooves on the inside of the sleeve. When the sleeve, carrying the bolt, is pushed forward until forward motion of the bolt is stopped by the head of the receiver, the sleeve continues forward, and its grooves, acting on the ribs of the bolt, compel the bolt to revolve, engaging the locking lugs in their corresponding cuts in the receiver. Thus a straight pull backward and forward of the bolt sleeve causes the bolt to revolve into and out of its engagement with the locking threads in the receiver. When the bolt and sleeve are drawn together to the rear the extractor on the side of the sleeve, engaged with the head of the shell, draws the empty shell to the rear until the ejector can strike it on the left side of the head, ejecting the shell out on the right side of the receiver. A familiar application of this straight pull system is the spiral screw-driver, in which a push forward on the handle compels the blade of the tool to turn, driving in or turning out the screw.

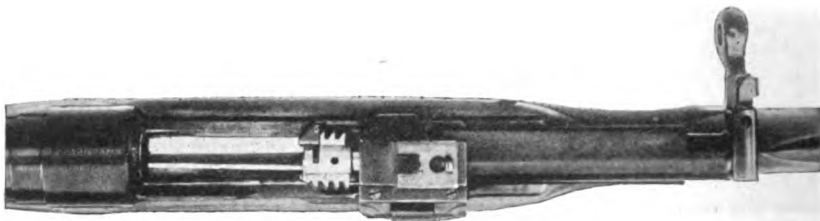

Fig. 12

Top view of Ross rifle action, showing bolt open

The magazine is almost exactly the same as the familiar Mauser magazine. When the bolt is fully pulled to the rear, the top cartridge in the magazine rises slightly and is thus presented in front of the bolt head, so that the bolt in moving forward pushes it from the magazine into the chamber. There is a magazine cut-off on the left side of the receiver which operates exactly like the cut-off on the U. S. Model 1903 (Springfield) rifle. When the cut-off is turned down, the magazine is cut off and held in reserve, and the rifle can then be used as a single loader with no reference to the cartridges in the magazine. When the cut-off is turned up, the cartridges feed from the magazine

into the chamber as the bolt is worked back and forth. When the cut-off is placed half way between "ON" and "OFF," the bolt can be pulled to the rear completely out of the receiver.

The trigger pull mechanism is very simple and ingenious. There is the usual safety pull seen in most bolt action rifles, the trigger moving to the rear about $\frac{1}{8}$ inch against the pressure of the sear spring. After this is taken up the trigger has a very clean pull of about 3 pounds, absolutely free from creep. In fact I consider the trigger pull on the Ross the best of all the bolt action rifles, as it always comes from the factory in excellent shape and does not require any refining as do almost all other bolt action triggers.

Many persons have thought the Ross action unsafe because the bolt pulled straight to the rear to open the action, without the familiar turn up and down motions. An examination of the mechanism will show that there is absolutely no foundation for such a belief. There is absolutely no tendency for pressure on the bolt head to unlock the bolt. In fact it is a mechanical impossibility so to unlock it. On account of the size of the various parts, the distribution of metal in the bolt and receiver, and the interrupted screw system of the locking lugs, I consider the Ross to be the safest and strongest action on the market today so far as ability to withstand the explosion of the cartridge is concerned.

The Mauser system of turning up and down of the bolt causes the first opening movement of the bolt, and its final closing movement, to be actuated by a powerful cam. This cam motion gives great force to the final insertion, and first extraction of a cartridge into and out of the chamber. Should the cartridge stick in the chamber, or should there be a little dirt in the chamber, this power will adequately take care of it and no trouble will be found in the insertion or extraction of cartridges. The Ross action is not as powerful in this respect, and therein lies its one fault—its lack of power to insert and extract oversized cartridges, or cartridges that stick. In the two Ross rifles that I have owned I have experienced considerable trouble from this source. Both of these rifles have been .280 caliber. The .280 fired shell seems to stick firmly in the chamber at times, and then one has considerable trouble in opening the rifle, due to the lack of ability to apply the same power that can be applied by the Mauser system with its powerful cams.

The Ross is an extremely quick action. It can be operated almost twice as fast as the ordinary bolt action, and it is very easy to operate it while retaining the rifle at the shoulder in rapid fire. In

.303 caliber it works easily and very smoothly, as the .303 shells do not seem to have the same tendency to stick in the chamber that the .280 shells do.



Fig. 13
Side view of Ross rifle action, bolt closed

This rifle is generally made in two calibers: the .280 Ross, and the .303 British. A few rifles have been made for the .30-caliber Model 1906 and .35 Winchester center fire cartridges. The .280 Ross, particularly, is a cartridge of extremely high velocity, about 3050 feet per second, and of very flat trajectory. It is loaded with a 142 grain, pointed, copper-tube, expanding bullet for big game shooting, and with a 180 grain, pointed full-jacketed bullet for long range target shooting. The long-range target cartridge has a velocity of about 2800 feet per second and is very accurate, and a most satisfactory cartridge for military target shooting, combining accuracy, flat trajectory, and the minimum of wind deflection. The sporting cartridge is not a particularly accurate one, groups running from $8\frac{1}{2}$ to $12\frac{1}{2}$ inches at 200 yards. This is to be greatly regretted as its great killing power, very flat trajectory, and high velocity make it very desirable, particularly for long range game shooting.

A large amount of attention has been devoted to the exterior shape and dimensions of the .280 Ross barrel. Effort has been made to make its whip or movement when fired such that it will discharge a cartridge with a slight under-charge of powder at a slightly higher barrel elevation, or higher point in its flip, than it does a normal cartridge. The idea is to start a bullet flying at a slightly smaller velocity from the muzzle at a very slightly greater elevation so as to compensate for the lower point of impact. In practice it is found that practically all cartridges may vary as much as 20 feet over or under in velocity, notwithstanding the fact that the powder charges weigh exactly the same, and this the Ross Com-

pany have endeavored to allow for in the shape and peculiar vibration of their barrels. The manufacturers claim superior accuracy from this arrangement. I have never seen this actually proved in tests, but at any rate it does not injure the accuracy.

At the beginning of the Great War the Canadian troops were all armed with the Ross .303 rifle. These rifles have now been all displaced by the Enfield among the Canadian troops in France, the Ross only being used for the purpose of training the troops in Canada before they are sent to Europe. There were several reasons for thus displacing the Ross: First, and probably foremost, was the desire, in fact the necessity, of having all the troops of the English Empire armed with one rifle in order to simplify the matters of supply, repair, and issue of small parts. It is said that the Ross did not stand up well in the trenches in comparison with the Enfield. The bolt is rather difficult to take apart for cleaning, and the whole rifle itself is rather more difficult to keep clean and in smooth working order than the Enfield. This was of considerable importance in trench warfare where the rifles were at almost all times subjected to the maximum of dirt and mud. The power exerted by the mechanism to insert or extract oversized or slightly deformed cartridges, or to operate the action when it was dirty, did not compare favorably with the Enfield. In theory the action is fine, but in practice, particularly under the severe conditions of military service, it could not stand up with the ideal Mauser type of action. It is, however, as powerful and as reliable as any of the lever action rifles, and practically the only trouble with it in the hands of sportsmen has arisen from the tendency of fired shells in .280 caliber to stick very tightly in the chamber on occasions. For example, in the firing of 100 rounds of .280 cartridges on the target range under the most favorable conditions, six shells stuck tightly enough to bother one a lot in rapid fire, and four stuck so tightly that it was necessary to place the butt of the rifle on the ground and open the breech by means of the heel of the shoe applied to the bolt handle.

THE NEWTON HIGH POWER RIFLE

This is a bolt action rifle, quite similar to the Mauser rifle, but with a number of important improvements which fit it more particularly for sportsman's use. It is essentially a sportsman's weapon intended for large game shooting. It differs from the Mauser in the following points: Instead of having solid locking lugs at the head

of the bolt, the Newton has lugs of the interrupted screw type, quite a little stronger than the solid lugs, but more liable to accumulate dirt. The safety is placed on the side of the sleeve instead of on top, and more readily operated than is the Mauser type. When in the safe position the thumb piece stands vertical, and is moved to ready by turning it to the rear so that it stands 45 degrees below the horizontal. The bolt handle turns well down at the side of the stock and is more refined in shape. The bolt stop is very ingeniously arranged and is operated by the front trigger. Pulling the trigger to the rear when starting to open the bolt operates the stop so that the bolt can be withdrawn completely from the receiver. The magazine floor plate is hinged at the front end, and retained in position by a spring stud in rear. When the floor plate is open it acts as a screw-driver for the front take-down screw. Turning the floor plate around unscrews this screw. The tang screw in rear of the trigger guard is then unscrewed and the stock and magazine separate from the barrel and receiver, permitting the rifle to be packed in small space. Provided the screws are always kept screwed up very tight, this method of take-down is not open to the same objections as all other methods of take-down, as it is really only a removal of the stock. The rifle has double set triggers that are much more reliable than those usually seen. The regular length of barrels is 24 inches. The whole arm is well proportioned, well balanced, and light.

Right side view

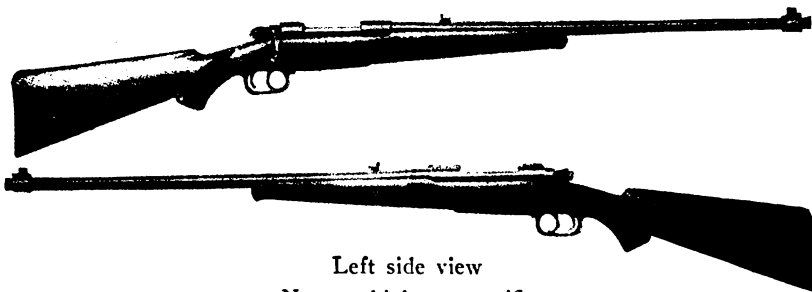
Left side view
Newton high-power rifle

The Newton rifle is adapted to the .22-, .256-, .30-, and .35-caliber Newton high-power cartridges, and to the .30-caliber Model 1906

cartridge. These are all cartridges of very high intensity, and of extremely high velocity. The magazine will hold but three of the .30 and .35 Newton cartridges, and five of the others.

The rifling is what is known as segmental, a modification of the English Metford rifling, the corners of the lands and grooves being rounded instead of square. The rifling cutter is made with its edge ground on an arc of a circle having a shorter radius than that of the bore. The advantages that the manufacturers claim for this system of rifling are far greater ease of cleaning, greater durability, increased accuracy, and less strain on the bullet jackets in firing. I will acknowledge the first and last advantages, but I am not so sure of the durability. There would seem to be more liability of the bullet to ride up on the inclined surface of the rounded lands, and thus to increase the friction.

The stock is of very good shape and design, and has a well-shaped pistol grip. The butt plate is of steel, not checked to prevent slipping and is not placed on the stock at the right angle, the measurement from trigger to toe being greater than the distance from trigger to heel, and in consequence there is a tendency for the butt to slip down on the shoulder during rapid fire.

It takes considerable time to perfect a new arm so that it is as satisfactory as can be made, considering the design. It is a very rare thing to find that a new arm, assembled entirely from the inventor's design, will work satisfactorily at the start. A long time, sometimes as much as a year, must be devoted to smoothing down, finding the weak parts and rectifying them, and making the arm thoroughly reliable in every respect. Thus the large arms companies usually keep a new arm in their shops for a number of months to thoroughly standardize it before they put it out to the trade. All this takes capital and experienced workmen, which a concern just starting seldom has. The new concern must start to realize on their capital as soon as possible. Thus the Newton Arms Company seems to have been obliged to place some of their product on the market before it was thoroughly standardized. As a consequence we find that many of their earlier rifles may require considerable smoothing off and adjustment before they will operate satisfactorily. It is of course to be expected that as the firm and its workmen gain more experience these faults in standardization will be corrected. In fact I have before me now (March, 1918) a rifle which has just come

through the factory in which this seems to have been done, as it works smoothly and easily, handles its cartridges correctly, and the parts seem to be in proper adjustment.

In regard to accuracy of the various cartridges, the reader should refer to these particular cartridges in Chapter XI. Up to the time of going to press the Newton Arms Company have not completely developed their .22 Newton, and .35 Newton cartridges.

INSTRUCTIONS FOR USING NEWTON HIGH POWER RIFLES

These rifles are of the bolt action magazine type and may be used either as a single loader or a magazine rifle.

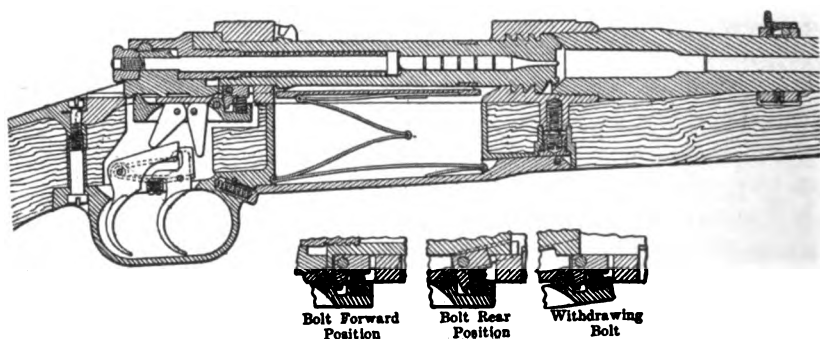

The new Newton bolt stop mechanism
Patents pending

To use as a single loader raise the bolt handle, which cocks the arm; draw the bolt handle to the rear until checked by the bolt stop; place a cartridge on the magazine follower in front of the bolt or slide it forward into the chamber; push the bolt forward and turn it down into place. The gun is then loaded and cocked ready for firing.

To use as a magazine rifle withdraw the bolt its full length until checked by the bolt stop; fill the magazine with cartridges by placing them in the magazine throat in front of the bolt and pressing them down until caught by the magazine throat. Continue this until the magazine is filled. Clips, the same as used in the United States Springfield army rifle, may be used with the .22-caliber, .256 Newton and .30 U. S. G. cartridges, and in such case place the clip in the clip-way, press down with the thumb on the upper cartridge and the entire clip full of cartridges strips down into the magazine. Pushing the

bolt forward into position and turning down the bolt handle will then remove the upper cartridge from the magazine into the chamber and the rifle is ready for firing. If desired to carry a full magazine as well as the rifle loaded, after the magazine is filled press another cartridge upon the upper cartridge in the magazine, pressing the fifth cartridge down sufficiently far that it clears the bolt, and the bolt will then shove the extra cartridge into the chamber. This leaves the magazine completely filled and a loaded cartridge in the barrel.

In firing if it is desired to use a set trigger first draw the rear trigger backward until it catches. A very light touch on the front trigger will then serve to discharge the weapon. If the rear trigger be not drawn back pressing the front trigger fires the weapon the same as with a single trigger rifle.

The use of the safety. The safety is located on a shaft at the upper rear right hand corner of the sleeve, the shaft going transversely through the sleeve. When in firing position the safety is to the rear and pointing 45 degrees below the horizontal. When carrying the rifle at safe turn the safety leaf into a vertical position. The proper position can be felt as there is a spot on the shaft which is engaged by a poppet. In this position the firing pin is locked back and the bolt is locked against rotation. To permit the bolt to rotate while the firing pin is locked move the safety forward until it is 45 degrees above the horizontal where another stop can be felt as engaged by the poppet. This permits free rotation of the bolt yet the firing pin is locked.

For carrying in a scabbard or where the safety is exposed to undue danger of being accidentally moved, push the safety leaf forward until it points directly ahead. In this position the bolt handle is locked against rotation and the firing pin locked. The safety can be brought from this position back to the firing position either by completing the rotation past the lower side of the bolt or by reversing the movement by which it was put on.

To remove the bolt from the arm turn up the bolt handle and draw backward on the bolt, at the same time pressing backward on the front trigger. The backward pressure on the front trigger causes the forward portion of the sear to rise up and engage a detent finger on the lower side of the bolt stop, which is located under the rear receiver bridge. This prevents the bolt stop from rising and permits withdrawing the bolt completely from the rifle. This pressure on the trigger and consequent action of the sear must be applied before the

bolt stop has entered into the notch of the lower side of the bolt, as the trigger has no power to draw the bolt stop down, once it has risen, but merely holds it down if caught before it has risen at all.

To take down the arm for carrying press in the magazine floor plate catch immediately in front of the trigger guard until it releases the rear end of the magazine floor plate, which is thrown down by the pressure of the magazine spring; swing the floor plate, which is pivoted in the front receiver screw nut, down to its lower position, and, using it as a lever, unscrew the nut off the front receiver screw and the barrel will unhook and barrel and receiver together tip upward and off the stock, leaving the guard with trigger mechanism, magazine, etc., with the stock. Press the forearm screw nut up into the guard forging at its front end until it is flush, then press the magazine floor plate up close against the magazine until it is caught by the magazine floor plate catch. The rifle is then ready for the case.

To dismount the bolt cock the rifle by raising the bolt handle and turning it down again into place. Turn the safety up and forward until at an angle of 45 degrees in front of the perpendicular. This will permit the bolt handle to rotate while the firing pin is locked. Raise the bolt handle and withdraw the bolt completely from the rifle. The sleeve may then be unscrewed from the bolt by rotating it from left to right, as it is a left hand screw.

To dismount the sleeve: Remove the bolt and remove the sleeve from the bolt as above stated. Throw the safety back to the firing position, which is to the rear and 45 degrees below the horizontal, which relieves the strain on the main spring. Rest the point of the firing pin upon some hard substance and press the sleeve forward, thus compressing the main spring until the V-shaped projections on the sides of the firing pin nut are clear of their seats in the cocking head. Unscrew the firing pin nut from the rear end of the firing pin. This separates the firing pin, main spring, cocking head and firing pin nut from the sleeve proper.

To dismount the safety mechanism: Having dismounted the sleeve as last above described, turn the leaf of the safety until it projects directly to the rear and pull it out to the right. The sleeve locking bolt with its spring and the poppets bearing against the safety and rear end of the bolt, with their springs, may then be pushed out with a match or other small drift.

To remove the guard forging: Unscrew the rear receiver screw immediately to the rear of the trigger guard and the front guard

screw and this forging may then be either drawn out from the bottom or pushed down from the top.

To remove the rear tang from the stock: First remove the rear receiver screw, then unscrew the rear tang screw running from the center of the pistol grip cap into the rear end of the rear tang until it is free of the tang, then press upward on the end of this screw and it will force the rear tang upward and out of its seat in the stock.

To remove the extractor from the bolt remove the bolt from the rifle. Turn the extractor around to that side of the bolt which is to be left when the bolt is in position and to the bottom when it is being withdrawn. This will free the jaw of the extractor from the groove next the bolthead. Push the extractor forward and it will slide off the bolt.

To assemble the rifle reverse the operations of dismounting.

UNITED STATES MAGAZINE RIFLE, MODEL 1898

This rifle is popularly known as the Krag-Jorgensen. It was the service arm of the United States Army prior to the adoption of the Model 1903 rifle. The Krag-Jorgensen rifle was adopted by the United States Army in 1892. Three models of it have been issued, the 1892, 1896, and 1898, the latter embodying certain small improvements over the former models. The Model 1899 carbine has exactly the same action as the Model 1898 rifle. All of the Krag-Jorgensen rifles use the .30-caliber, Model 1898 cartridge, known as the .30-40.

This is a bolt action magazine rifle, having a box magazine of quite different construction from other magazines seen on American rifles. The magazine lies horizontally under the receiver. Cartridges are inserted in it, one at a time, through a gate on the right side of the rifle, and pass to the left and up in front of the bolt to be fed into the chamber. The Model 1898 rifle has a 30-inch barrel, and the Model 1899 carbine a 22-inch barrel. The muzzle velocity of the bullet fired from the rifle is 2000 feet per second, and from the carbine 1920 feet per second. The magazine holds 5 cartridges. A magazine cut-off is provided so that the cartridges in the magazine can be held in reserve, and the rifle used as a single loader. The magazine may be filled while the bolt is closed.

The Model 1898 rifle has been furnished with three different models of rear sights. The Model 1898 rear sight has a leaf hinged at the front and lying horizontally. Elevation is obtained by running the slide forward over the curved elevation ramp of the base, and secur-

ing it with a thumb screw. The eye-piece is adjustable for windage, and has three open sight, U-shaped notches, two on either side of the center notch, by means of which ten points of windage can be instantly obtained without adjustment. The Model 1901 rear sight, which is the one most commonly seen, is somewhat similar to the Model 1905

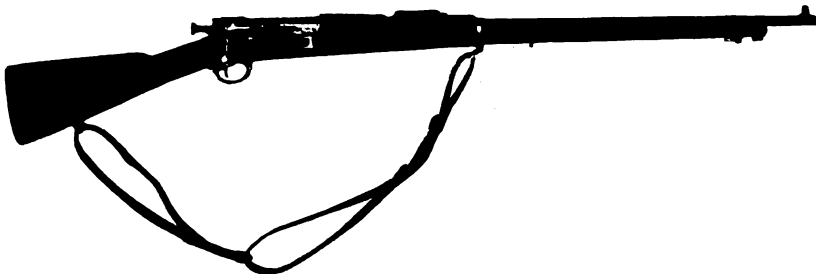
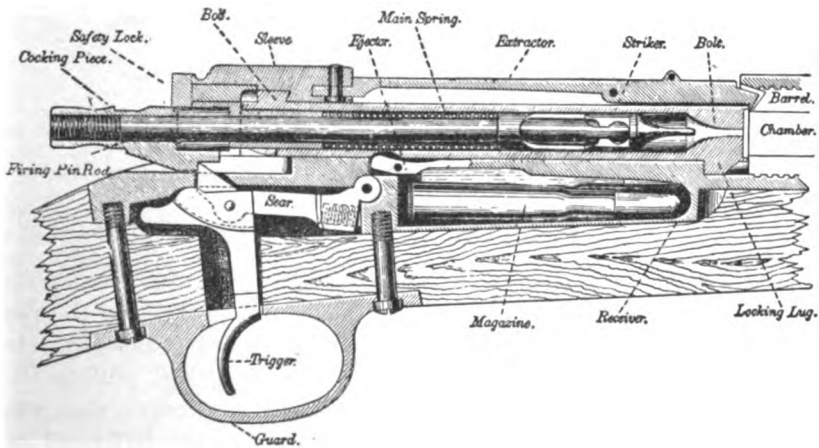

Fig. 14
The United States magazine rifle, Model 1898
(Krag-Jorgensen)

rear sight which is the regular sight for the Model 1903 rifle. The fixed base is pivoted at the front and has a lateral movement for windage adjustment, being pushed by hand to the right and left, and secured by a cam lever at the forward end of the fixed base. The slide contains a battle sight, and an open and peep sight for use with the leaf elevated. The battle sight, which is used with the leaf laid flat, adjusts from 100 to 400 yards. When the leaf is raised the open sight permits of elevation from about 525 yards to 1900 yards and the peep sight from 100 to 1750 yards. The Model 1902 rear sight is similar to the Model 1898, but the eye-piece has but one open sight notch, and also has a peep plate which may be snapped into aiming position in front of the open sight. It is adjustable from 100 to 2000 yards. On all three sights a movement of one point on the wind-gauge will move the point of impact one inch per every hundred yards of range.

The magazine of the rifle is filled by opening the magazine gate and inserting cartridges, one at a time, into the magazine, bullet to the front, and taking care that the rim of one cartridge lies behind the rim of the preceding cartridge. Closing the gate operates to press the follower against the last cartridge, and the spring behind the follower presses the cartridges to the left and up into position to be engaged, one at a time, by the face of the bolt as the latter is operated. The bolt is operated in the usual manner by turning it up and pulling it

to the rear, which extracts and ejects the empty shell and compresses the mainspring. Moving the bolt forward and turning the bolt handle down forces a cartridge from the magazine into the chamber, turns the one locking lug at the head of the bolt down into its recess in the receiver, and locks the rifle ready for firing. When the cut-off is turned down the top cartridge in the magazine is slightly depressed so that the bolt does not engage it as it moves forward, and thus the cartridges in the magazine are held in reserve and the rifle can be used as a single loader without reference to the cartridges in the magazine. The rifle may be locked against discharge by means of a safety lock on the sleeve in a similar manner to the safeties on the Mauser and Model 1903 rifles.



Action of the Model 1898 rifle, showing the names of the various parts

To dismount the bolt mechanism. Draw the bolt fully to the rear, then place the piece across the hollow of the left arm. Lift the front end of hook of the extractor off the bolt with the left thumb, and at the same time turn the bolt handle to the left with the right hand. The bolt can then be withdrawn from the receiver. Take the bolt in the left hand, back of the hand down, bolt upside down. Grasp the cocking piece with the right hand. Slightly draw back the cocking piece and turn it towards the operator until the firing pin can be removed from the bolt. Take the firing pin in the left hand and bear down on the point of the striker until it leaves the firing pin; remove mainspring from the firing pin, and the latter from the sleeve.

To dismount the magazine mechanism. The gate being closed, en-

gage the flanged head of a cartridge case under the lug on the front end of the hinge bar head and turn the latter towards the gate, out of its seat; then bear heavily on the gate with the palm of the right hand, to overcome the pressure of the magazine spring, and, with the left, press forward against the lug, drawing the hinge bar from the receiver. Remove the gate, magazine spring, carrier, and follower.

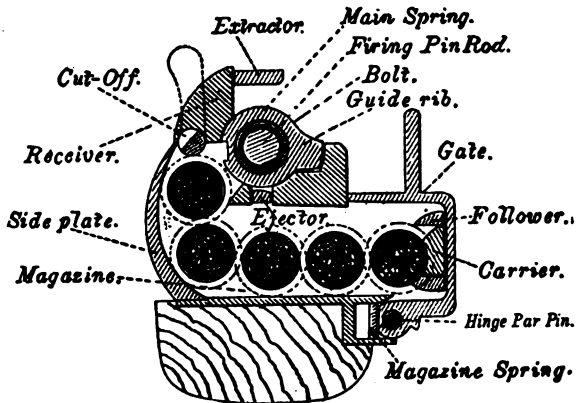

Sectional cut showing how the cartridges lie in the magazine. Model 1898 rifle

To assemble the bolt mechanism. Observe that the safety lock is turned to the left. Place the firing pin in the sleeve, and the mainspring on the firing pin. Hold the cocking piece against the chest, and with the right hand compress the mainspring, pulling it up towards the sleeve on the firing pin. Replace the striker, and release tension on mainspring. Grasp the bolt handle in the left hand as in dismounting, and the firing pin in the right hand, extractor uppermost. Insert firing pin in the bolt. Grasp the handle of the bolt with the fingers of both hands, bolt directed downward and away from body, and with both thumbs in rear of the safety lock push strongly forward and turn to the right with thumbs until the arm of the sleeve engages the collar of the bolt. Grasp the bolt and cocking piece and draw back and turn the cocking piece from the operator until its nose enters the notch on the rear end of the bolt. Take the bolt in the right hand and introduce it into the receiver, keeping the extractor lifted. Turn the bolt to the right, and at the same time press strongly with the first finger against the right side of the extractor. The bolt will slip into its place in the receiver.

To assemble the magazine mechanism. Hold the rifle with the right

side uppermost. Insert arbor of carrier into its hole in receiver, and place the end of the left thumb across the magazine to prevent the carrier from swinging into the latter. Place the magazine spring in its channel, convex side up, rounded end to the rear, particularly observing that the lip at its front end rests in the notch on heel of carrier. Place gate in its seat, lug entering between carrier and magazine spring. Remove left thumb and at the same time press the gate against the magazine spring with right hand. Insert hinge bar in front hinge hole in the receiver with the left hand, and press the gate down strongly until the pin can be pushed through the gate into the rear hinge hole. After the hinge bar is fully home, turn the head into its seat by opening the gate.

The following table gives the principal dimensions and weights of the rifle and carbine:

Dimensions	Rifle Inches	Carbine Inches
Diameter of bore30	.30
Number of grooves	4	4
Twist, uniform, one turn in	10.	10.
Width of grooves166	.166
Width of lands0589	.0589
Depth of grooves004	.004
Length of barrel	30.	22.
Distance from top of front sight to sighting notch, leaf vertical	24.655	16.655
Crook of stock from axis of bore to heel of butt.....	1.85	1.85
Stock distance from trigger to butt-plate	13.37	13.37
Length of rifle complete without bayonet	48.9	40.9
Weights	Pounds	Pounds
Total weight of arm without bayonet	9.187	8.075
Weight of barrel	3.117	2.528
Weight to compress mainspring	16 to 18	16 to 18
Weight of 100 cartridges	6.327	6.327

For ballistics and data concerning the cartridge see under .30-caliber Model 1898 cartridge in Chapter XI.

The Model 1898 rifle is a most excellent arm. It was used in the United States Army from 1892 to 1905 with excellent results. It has the reputation throughout the service of standing more abuse and still keeping in serviceable condition than any weapon ever used by our army. That it was superseded by the 1903 rifle was not due to any fault of the arm but to the fact that its mechanism was such that the cartridges had to be loaded one at a time into the magazine, and it could not be altered for clip loading which modern battle field conditions require. Also, with the smokeless powders in use at the time that it was discarded, the cartridge could not be given sufficient velocity

to keep pace with other nations and still keep within the safety limit as regards breech pressure. The bolt has but one locking lug at its head as compared with two lugs on the Mauser and Model 1903 rifles. This fact made it unwise to use ammunition giving pressures in excess of about 43,000 pounds per square inch.

This rifle is at present much used by the various civilian rifle clubs throughout the country. It is fully as accurate as any rifle manufactured in the United States, and as accurate as the Model 1903 rifle, although of course it does not have the extremely high velocity of that rifle, and as a consequence its bullet is more effected by wind, and at long ranges as good scores in windy weather cannot be made on this account. As explained in the chapter on cartridges, this cartridge can now be reloaded with the new powder and the sharp-pointed bullets to give ballistics almost equal to the Model 1906 cartridge.

The Model 1898 rifle was used by all the expert military rifle shots in this country from 1901 to 1906, and excellent results obtained with it. At that time the favorite charge consisted of the 220-grain jacketed bullet and 36.2-grains of Laflin and Rand (Hercules) W. A. .30-caliber powder. This load gave better results, particularly at 1000 yards, than the regular service load which contained only about 34.5 grains of the same powder. For the best work at long range the sights were always adjusted by means of a micrometer or vernier sight adjuster, reading to minutes of angle, the elevations required at the various ranges on these instruments being as follows for the Government cartridge :

Ranges	Rifle	Carbine
From 200 to 300 yards, raise elevation.....	6	4.9
From 300 to 350 yards, raise elevation.....	3	2.7
From 350 to 400 yards, raise elevation.....	4	2.9
From 400 to 500 yards, raise elevation.....	7½	6.6
From 500 to 600 yards, raise elevation.....	9	7.7
From 600 to 800 yards, raise elevation.....	14	..
From 800 to 900 yards, raise elevation.....	15	..
From 900 to 1,000 yards, raise elevation.....	16	..

With the carbine the micrometer adjuster does not give the true minute as the sights are closer together than with the rifle, and the adjuster is made only for the rifle's sight radius. Today the best ammunition for target shooting at short or long ranges is that loaded with a pointed bullet of about 172 or 180 grains as explained in Chapter XI.

These rifles, and the carbine especially, are frequently remodelled into sporting arms. The carbine, just as it is, makes a very good sporting rifle, but if sights better adapted to hunting than the military sights are desired, the front sight can be removed and replaced with an ivory bead sight, the rear sight removed entirely, and a Lyman No.

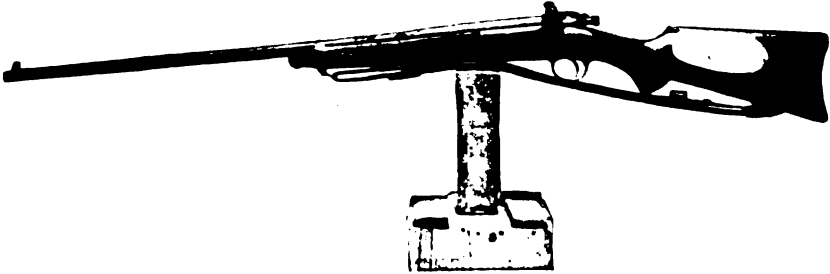

Fig. 15

Remodelling Krag rifle with Winchester Model 1895 barrel

48 rear sight, with eyepiece reversed, fitted to the left side of the receiver. If the owner considers that the removal of the rear military sight makes the rifle unsightly at that part, then a new hand-guard without recess for the rear sight can be made and fitted. I used a rifle converted in this way for two years in the Phillipine Islands with excellent results. The military stock is capable of being shaped up into a very fine, straight, grip shotgun stock, and is best when fitted with a Silver soft rubber recoil pad, as this gives the stock the required length and finish. I do not know of a better arm than this to stand the hard work and abuse of real wilderness exploration.

If one gets a hold of a Krag rifle having a worn-out barrel, the .30-40 barrel exactly as made for the Winchester Model 1895 rifle, but of course fitted for the thread and extractor of the Krag, can be fitted to the action, and this gives a splendidly appearing and balancing arm. I have such a rifle with a special hand-made pistol grip stock which I value very highly.

THE UNITED STATES MAGAZINE RIFLE, MODEL 1903

This rifle, popularly known as the New Springfield, was developed and manufactured at the Springfield Armory in 1902 with a view to its adoption by the United States Army to replace the Model 1898 (Krag Jorgensen) rifle with which the Army was at that time armed. The Spanish-American War had shown the desirability from a military

standpoint of a rifle with which five cartridges could be loaded at once into the magazine by means of a clip. The Spanish Mauser could be so loaded, but owing to its construction it was only possible to load single cartridges into the magazine of the Model 1898 rifle. Also it was desired to increase the velocity from 2000 feet per second (Krag) to about 2300 feet per second in order to keep pace with other nations.

The action of this rifle is a very close copy of the German Mauser rifle, with the exception of the two-piece firing pin, and the combined bolt release and magazine cut-off. The latter is designed to permit of cutting off the magazine, and permitting the rifle to be used as a single loader while the magazine is held in reserve.



Fig. 16
The United States rifles, view of right side
Upper — Model 1903
Lower — Model 1917

The rifle was first issued to the service in the winter of 1904-05, and was at that time chambered for the Model 1903 cartridge. This cartridge was very similar to the present 1906 cartridge except that the neck of the shell was slightly longer, and it used a 220-grain, blunt-point bullet, practically the same bullet as was used in the Model 1898 (Krag) cartridge. The shell was loaded with sufficient Laflin and Rand W. A. (nitroglycerine) powder to give a muzzle velocity of 2350 feet per second. It was soon found that with this powder charge the erosion was so excessive that the barrels became worn out in about 800 rounds. The powder charge was therefore reduced to give a muzzle velocity of 2200 feet per second. The breech pressure was about 44,000 pounds per square inch, and the maximum range 4247 yards. All the troops in the Regular Army were armed with this rifle.

In the year 1905 the German Army adapted a light, very sharp pointed bullet for their 8 mm. cartridge, giving to it the extremely high velocity of 2880 feet per second. The lessened air resistance of this sharp point was such that the remaining velocity of the bullet at all ranges was greatly increased, and as a consequence the trajectory was flattened, thus greatly increasing the danger space, a very great improvement from a military standpoint. Our own ordnance officers were not slow to recognize the improvement, and the Model 1903 rifle proved cap-

TARGET "C":

800, 900 & 1000 YARDS.

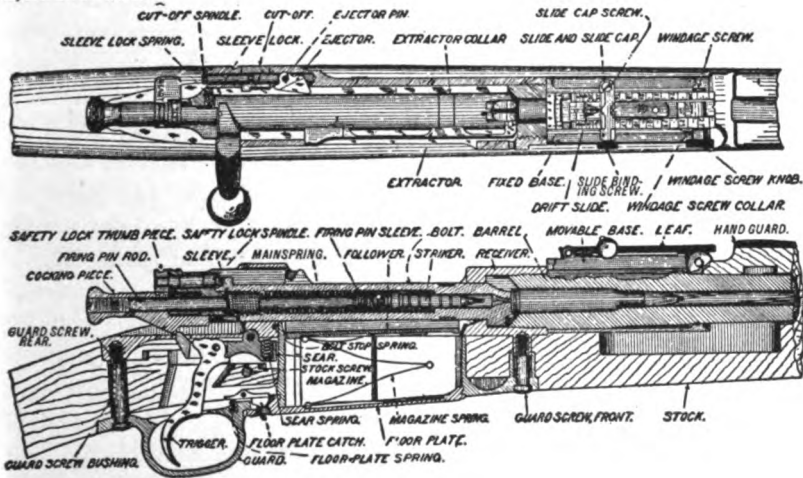

Fig. 17

Breech mechanism and nomenclature of the United States rifle. Model of 1903 able of certain small alterations to enable it to use the new ammunition. Experimental bullets were made and tried in the 1903 shell, and it was found that by slightly shortening the neck of the shell a 150-grain bullet with a 6 diameter sharp point could be used. It was decided to adapt this cartridge to the new rifle. The new cartridge is called the .30-caliber, Model 1906 cartridge, so we have a Model 1903 rifle using Model 1906 ammunition. To adapt the rifle to the new ammunition it was necessary to rechamber all the rifles already manufactured, cutting the barrel off at the breech and shortening it slightly. The barrel of the original rifle was 24 inches long, and this shortening for the 1906 ammunition accounts for the present standard length of barrel being 23.79 inches long. At the beginning we had to use the old W. A.

nitroglycerine powder, and the erosion was very serious. The Du Pont Company, however, quickly developed a pyro-cellulose powder for the rifle. Pyro-cellulose powders burn with a much cooler gas than nitroglycerine powders, and give very much less erosion. The powder has been steadily improved until today the present powder, Du Pont Military Rifle Powder No. 20, is a most stable, cool-burning powder that gives an accuracy life for the barrel of from 8000 to 11,000 rounds, over ten times the life of the bore with the old nitroglycerine powder. So much for the history of our present government rifle. We now come to a consideration of its construction and ballistics.

The rifle is a bolt action, military arm, copied, as has been said, from the German Mauser rifle. The box magazine holds five cartridges in two rows. The raising of the bolt handle cocks the rifle, compressing the mainspring by means of a cam. This cam also acts to start the withdrawal or extraction of the cartridge from the chamber, and the turning down of the bolt handle also causes the cam movement to insert the fresh cartridge in the chamber and seat it to the proper depth. This cam movement is extremely powerful, and is the feature that gives such excellence and efficiency to the Mauser type of action. A pressure of only 25 pounds on the bolt handle causes, by means of this cam, a force of 186.4 pounds being applied to the extraction or insertion of a cartridge. Thus there is a surety of loading cartridges and ejecting fired shells that few other rifles have. After the bolt handle has been turned up, the withdrawal to the rear of the bolt continues the extraction of the fired cartridge, and as the bolt reaches the end of its rearward travel the ejector passes through a slot in one of the locking lugs on the bolt, and projecting itself out in front of the bolt face, ejects the fired shell clear of the rifle and to the right. As the bolt is shoved forward its face engages with the head of the top cartridge in the magazine, forcing it out of the magazine and into the chamber. The turning down of the bolt handle completes the seating of the cartridge in the chamber, and also turns the bolt so that the two locking lugs at its head engage in recesses in the well of the receiver, locking the bolt against the explosion of the cartridge. When the cut-off is turned down, or "OFF," it limits the backward travel of the bolt, so that the bolt head does not go far enough to the rear to engage the head of the top cartridge in the magazine. As a consequence the cartridges in the magazine are held in reserve, and the rifle works as a single loader. When using the rifle as a magazine arm,

when the last cartridge has been fired the follower in the magazine comes up and engages the face of the bolt and prevents the bolt being closed. Thus the soldier is notified that his magazine is empty.

The barrel is 23.79 inches long, measuring from the rear of the chamber to the muzzle. It is covered with wood almost its entire length to protect it and also to facilitate handling by the soldier when the barrel becomes hot from repeating firing. The wood covering above the barrel is called the hand-guard. The following are the principal dimensions and weights of the rifle.

DIMENSIONS		Inches
Barrel:		
Diameter of bore		0.30
Exterior diameter at muzzle619
Exterior diameter at breech		1.14
Length of chamber and bore		23.79
Length of travel of bullet in bore		21.697
Diameter of chamber, rear end4716
Diameter of chamber, front end442
Diameter of neck of chamber, rear end3425
Diameter of neck of chamber, front end3405
Length of body of chamber		1.793
Length of shoulder of chamber16
Length of neck of chamber396
Length of chamber, total		2.3716
Rifling:		
Number of grooves, 4.		
Twist, uniform, one turn in	10.00	
Width of grooves1767
Width of lands0589
Depth of grooves004
Height of front sight above axis of bore		1.05
Distance from top of front sight to rear side of leaf, leaf raised		22.1254
Stock:		
Length, with butt plate		40.166
Crook, i. e., distance from axis of bore to heel of butt		2.089
Distance from trigger to butt plate		12.74
Length of gun complete		43.212
Sight radius		22.1254
Sight radius (battle sight)		21.5404
Width of single division on windage scale0207
WEIGHTS		Pounds
Barrel		2.79
Barrel, with rear-sight base and front-sight stud		3.00
Butt plate26
Receiver98
Bolt mechanism		1.00
Magazine and trigger guard44
Magazine mechanism, including floor plate17
Bayonet		1.00
Stock		1.58
Hand guard13
Front and rear bands, including swivels25
Rear sight, not including base20

	Pounds
Total weight of metal parts	7.30
Oiler and thong case19
Total weight of arm, including oiler and thong case, with bayonet.....	9.69
Total weight of arm, including oiler and thong case, without bayonet..	8.69
Weight to compress mainspring	16 to 18
Trigger pull (measured at middle point of bow of trigger).....	3 to 4½

MISCELLANEOUS DATA

Initial velocity	2,700 feet per second
Powder pressure in chamber	about 51,000 pounds per square inch
Weight of ball cartridge	about 395.5 grains
Weight of bullet	150 grains
Weight of powder charge	about 50 grains

One of the greatest advantages that this rifle, and in fact almost all military arms, has over the ordinary sporting rifle, is that practically every part of the mechanism can be dismantled readily without any tools whatever. It is easily possible for one accustomed to the operation completely to dismantle the breech mechanism of the Model 1903 rifle in fifteen seconds, and to assemble it in thirty seconds. This is of importance, not only to the soldier but to the sportsman as well, and particularly when the sportsman assays to explore unknown countries where he is out not for a couple of weeks but for months at a time, and thousands of miles from gunsmiths and even from screw-drivers and drifts. A rifle brought into a warm room or cabin during cold weather will sweat on every steel surface, and if it cannot be cleaned and wiped off at once inside it is going to rust there. Likewise, a canoe upset is liable at any time to make it necessary to clean the action of the rifle thoroughly, or desert dust will also make it necessary. In the tropics one perspires freely, and I have never been out for a day's hunt in the jungle that my rifle was not thoroughly wet *inside*, either from sweat or water. Once while travelling along the Caribbean coast in a dug-out canoe with some natives I had the misfortune to get swamped by a large wave a long distance from shore, and the canoe turned bottom up. Fortunately I kept a hold of my rifle and rucksack. We were over an hour getting ashore, and it was several days before I got to a place where it would have been possible to get either a screw-driver or oil. Fortunately my rifle was a Model 1903 remodelled into a sporting arm, and I had a field cleaner and oil bottle in the recess under the butt-plate. It was but the matter of a few moments when I got ashore to take the rifle all apart, dry and clean it thoroughly, and oil it.

To dismantle the Model 1903 rifle proceed as follows. Place the cut-off at the center notch; cock the arm and turn the safety lock to a

vertical position, raise the bolt handle and draw the bolt completely out of the receiver. Hold the bolt in the left hand, press the sleeve lock with the thumb of the right hand to unlock sleeve from bolt, and unscrew sleeve by turning to the left. Hold sleeve between forefinger and thumb of the left hand, draw the cocking piece back with middle finger and thumb of right hand, turn safety lock down to the left with forefinger of right hand, in order to allow the cocking piece to move forward in the sleeve, thus partially relieving the tension of mainspring; with the cocking piece against the breast, draw back the firing pin sleeve with the forefinger and thumb of right hand, and hold it in this position while removing the striker with the left hand; remove firing pin sleeve and mainspring; pull firing pin out of sleeve; turn the extractor to the right, forcing its tongue out of its groove in the front of the bolt, and force the extractor forward and off the bolt.

To assemble bolt mechanism. Grasp with the left hand the rear of the bolt, handle up, and turn the extractor collar with the thumb and forefinger of the right hand until its lug is on a line with the safety lug on the bolt; take the extractor in the right hand and insert the lug on the collar in the undercuts in the extractor by pushing the extractor to the rear until its tongue comes in contact with the rim on the face of the bolt (a slight pressure with the thumb on the top of the rear part of the extractor assists in this operation); turn the extractor to the right until it is over the right lug; take the bolt in the right hand and press the hook of the extractor against the butt plate or some rigid object, until the tongue on the extractor enters its groove in the bolt. With the safety lock turned down to the left to permit the firing pin to enter the sleeve as far as possible, assemble the sleeve and firing pin; place the cocking piece against the breast and put on mainspring, firing pin sleeve, and striker. Hold the cocking piece between the thumb and forefinger of the left hand, and by pressing the striker point against some substance, not hard enough to injure it, force the cocking piece back until the safety lock can be turned to the vertical position with the right hand; insert the firing pin in the bolt and screw up the sleeve (by turning it to the right) until the sleeve lock enters its notch on the bolt. See that the cut-off is at the center notch; hold the piece under the floor-plate in the fingers of the left hand, the thumb extending over the left side of the receiver; take bolt in right hand with safety lock in a vertical position and safety lug up; press the rear end of the follower down with left thumb and push bolt into the

receiver; turn bolt handle down; turn safety lock and cut-off down to the left with right hand.

To dismount magazine mechanism. With the bullet end of a cartridge press on the floor plate catch (through the hole in the floor plate) at the same time drawing the bullet to the rear; this releases the floor plate. Raise the rear end of the first limb of the magazine spring high enough to clear the lug on the floor plate and draw it out of its mortise; proceed in the same manner to remove the follower. To assemble the magazine spring and follower to floor plate, reverse the operation of dismounting. Insert the follower and magazine spring in the magazine, place the tenon on the front end of the floor plate in its recess in the magazine, then place the lug on the rear end of the floor plate in its slot in the guard, and press the rear end of the floor plate forward and inward at the same time, forcing the floor plate into its seat in the guard.

This dismounting is all that is necessary thoroughly to clean the entire breech mechanism. Should any of the smaller parts require dismounting, or should it be necessary to remove the stock from the rifle, proceed as follows:

To dismount the safety lock turn it to the dismounting bevel on the sleeve and remove it by striking the thumb piece a light blow. To dismount the sleeve lock, drive out the sleeve lock pin from the top and remove lock and spring, being careful not to lose the spring.

To remove the stock. Remove the upper band screw and drive the upper band forward and off the wood by a few sharp blows on the rear of the bayonet stud with a hardwood block or a brass rod. Press in rear end of lower band spring and drive forward the lower band by a few sharp blows on the lug and then on the top with the hardwood block, and move the lower band forward and off the stock. Draw the handguard forward until free from the fixed base of the rear sight, and remove it. Remove the guard screws and guard. Remove the barrel and receiver from the stock, taking care to *lift* the receiver out of its seat in the stock. To assemble, proceed in reverse order, taking care to see that the guard screws are screwed up very tight.

The front and rear sights are fastened to the barrel by means of bands, called the front sight fixed stud, and the rear sight fixed base. The front sight movable stud fits into the fixed stud by means of a transverse dovetail and the front sight itself, a thin steel blade with flat top, fits in a slot in the stud. The movable stud can therefore be adjusted in the fixed stud to cause the rifle to shoot at zero; that is,

to shoot center when the wind gauge is adjusted to center on windless days. When the sight is once thus adjusted a hole is drilled through both studs, and a screw placed therein, thus firmly binding the two together, and preventing the front sight ever being misplaced except by destructive force.



Fig. 18

United States rifle, Model 1903, remodeled into a sporting rifle, and equipped with Lyman No. 48 rear sight. From the author's collection

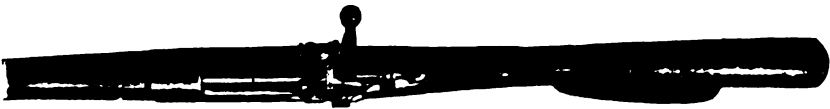

Fig. 19

United States rifle, Model 1903, remodeled into a sporting arm. Top view of action



Fig. 20

United States rifle, Model 1903, remodeled into a sporting arm. View of stock, showing Whelen model of cheek piece



Fig. 21

Floor plate of United States rifle, Model 1903, for rifle converted into a sporting arm, showing engraving, and insignia of The Camp Fire Club of America. From the author's collection.

The rear sight movable base fits into the rear sight fixed base cuts, being screwed into them by the wind gauge screw. It is also pivoted on a lug on the fixed base so that when the wind gauge screw is turned the movable base works from side to side through the cuts in the fixed base, thus giving adjustment for windage. The movable base carries a scale called the wind gauge scale which is divided into points. An adjustment of one point causes a lateral change in the point of impact of 4 inches per every hundred yards, or approximately 4 minutes of angle. The fixed base also carries the leaf, and the slide is attached to the leaf and slides up and down thereon. The slide carries the rear sights, really four in number. There is the battle sight on the top of the slide when the leaf is laid flat. This battle sight is adjusted to 547 yards on the theory that it gives the greatest danger space if aim be taken at the belt of an advancing or retreating enemy. At the muzzle and at 547 yards the enemy would be hit in the belt, and at mid range in the head without any estimation or allowance for range. Under the slide is the drift slide, a thin piece of metal which carries an open sight in a triangle, with a peep sight below it. Both these sights are adjustable from 100 yards up. On the top of the slide when the leaf stands vertical is a third open sight which can be adjusted for extreme ranges up to 2700 yards. Also on the top of the leaf is another open sight notch adjustable for the highest range to which the rifle is sighted — 2800 yards.

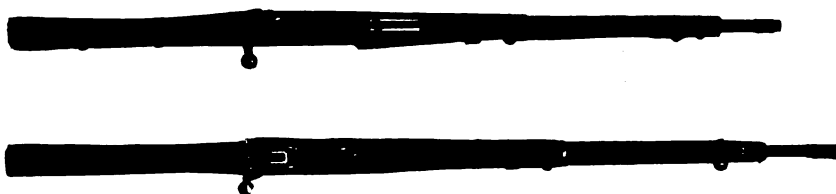

Fig. 22
The United States rifles. Top view
Left — Model 1903
Right — Model 1917

The rifle was first issued with an excellent rear sight similar to that illustrated in Fig. 49. This was a purely military rear sight, and did not satisfy the military rifle shots, particularly those interested in competitions, and pressure was brought to bear on the Ordnance Department to change it, which resulted on the present compromise sight, really not particularly good for either military shooting or target shoot-

ing. For target shooting the peep sight is used almost exclusively. In fact at the national matches which are held every other year the peep sight is used to the absolute exclusion of the open sight for all shooting at bull's-eye targets. The riflemen gathered at these competitions represent the very best shots in the country, and their selection of the peep sight for all shooting where the battle sight is not absolutely prescribed is an indication of the superiority of peep sights over open sights. And yet the peep sight on this rifle is a very poor one, being very much too far from the eye, hard to see, and obscuring most of the target.

One who has been shooting a black powder rifle, or even a high power rifle having a velocity around 2000 feet per second, finds a decided change when he comes to fire the Model 1903 rifle. The extremely high velocity makes very much less allowance necessary for distance, and also less allowance for moving objects or running game. The report is much sharper, although not particularly louder, and one must be careful not to get his ear near the muzzle of the rifle when some one else is firing it. He will find the accuracy also probably much superior to the weapon that he has been using. The short stock will bother him a little until he becomes used to it. But probably the greatest difference that the rifleman experienced with other arms will notice will be the great difficulty in cleaning the rifle after the service cartridges have been fired in it. This is due to the fact that at the extremely high velocity (2700 feet per second) and very high pressure (50,000 pounds per square inch) some of the cupro-nickel jacket of the bullets adheres to the bore, or else the bore gets a very thin, invisible plating of cupro-nickel. It is impossible to remove this without a very strong ammonia solution to dissolve it by chemical action. The primer used with smokeless powders always makes the powder and primer fouling deposited in the bore extremely acid in character, and some of this acid fouling practically always gets imprisoned under the metal fouling. As a consequence, unless the metal fouling be removed promptly after firing the acid fouling gets in its work and rusts the rifle. If the rifle be cleaned in the ordinary manner with alkaline oils or powder solvents the acid fouling under the metal fouling will not be touched, and the day after the rifle has been fired an examination of the bore will show it to be apparently fouled again. Patches passed through the bore will come out very black. If the bore be neglected for a couple of days patches passed through will come out red with rust. The bore can be kept polished by cleaning every day with oils or powder solvents, combined

with a lot of rubbing with the patches, but this kind of cleaning alone, without the ammonia solution, really consists simply in polishing off the surface rust which appears from day to day, and with the rust always goes a little metal. The result of this lack of intelligent care is the ultimate ruination of the bore of the rifle through rusting. On the other hand, if the rifle have the ammonia solution used in the bore not later than the evening of the day on which it was fired the solution dissolves all the metal (cupro-nickel) fouling, and being an alkaline neutralizes the acidity of the powder and primer fouling. It is only necessary then to dry and clean the bore well with patches, and then oil it to preserve it in perfect condition. Despite its high velocity and extreme pressure, this rifle has a very long accuracy life when it is

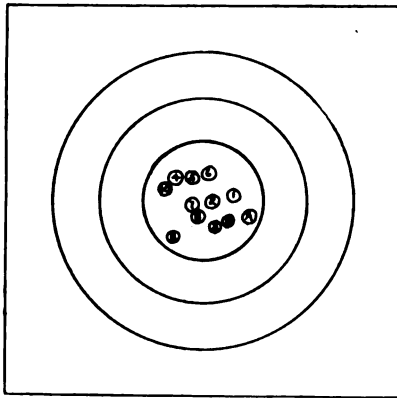

Fig. 23

Two sighting shots and ten consecutive shots fired at 600 yards by the author with U. S. rifle, Model of 1903, in the National Team Match, 1909. U. S. Cartridge Co., ammunition.

properly cleaned in this manner. Practically no loss in accuracy, even for long range target shooting, will be noticed up to 5000 rounds, provided the rifle be not used for an undue amount of rapid fire, and the accuracy for military purposes will last for from 8000 to 15,000 rounds. This matter has been gone into in detail because satisfactory results with this rifle cannot be expected for more than a short time unless one has a knowledge of how to care for this particular arm, and applies this knowledge. For detailed instructions as to the cleaning of these and other rifles see the chapter on The Cleaning and Care of the Rifle.

It has been stated that this rifle is very accurate. In fact it is the

most accurate rifle in the world, excepting only specially hand-made arms like the Pope and Neidner rifles. From a machine rest with accurate ammunition it will group its shots in a four-inch circle at 200 yards, or a 20-inch circle at 1000 yards, but the rifleman can hardly hold and aim this well, and about the human limit in this respect seems to be a 5-inch circle at 200 yards, and a 30-inch circle at 1000 yards. Possibles of 20 shots, all shots in a 36-inch bull's-eye, have been made several times at 1000 yards, and 10 shot possibles at this range are very common. This firing was all done in the military prone position, using the gun-sling as an aid to steady holding as described in the chapter on Holding and the Firing Positions.

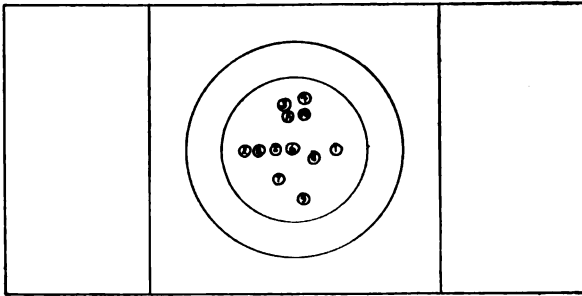

Fig. 24

Two sighting shots and ten consecutive shots fired at 800 yards by the author with U. S. rifle, Model of 1903, in the National Team Match, 1909. U. S. Cartridge Co., ammunition.

The Model 1903 rifle is sometimes remodelled into a sporting arm by sportsmen who have acquired a personal title to the rifle through a membership in the National Rifle Association or in one of the rifle clubs affiliated with the association. The work of remodelling is usually done by a skilled gunmaker. Ludwig Wundhammer of Los Angeles, California, and Fred Adolph of Genoa, New York, have remodelled many of these rifles in a most satisfactory manner. The military stock, rear sight, and rear sight fixed base are removed from the arm and not used. The entire barrel is polished and reblued, and a Lyman No. 48 rear sight is attached to the receiver, or a Lyman No. 1 rear sight of special pattern is fitted to the rear of the cocking piece (end of the bolt). The rifle is then restocked with a sporting stock to fit the owner, and a most excellent big game rifle results. In fact it is generally acknowledged that a remodelled Springfield rifle makes the very best big game rifle for every kind of American shooting that it is

TABLE OF FIRE FOR UNITED STATES RIFLE, CALIBER .30, MODEL OF 1903, MODEL OF 1905 SIGHT, AND 1906 AMMUNITION
 [Initial velocity = 2,700 feet per second. C = 0.3894075, determined experimentally at Frankford Arsenal.]

Range (yards)	Angle of departure (computed)		Angle of elevation (verified by firing)		Time of flight (computed)		Angle of fall (computed)		Remaining velocity (computed)		Remaining energy (computed)		Summit of trajectory (computed)	
	Deg.	Min.	Deg.	Min.	Seconds	Secs.	Min.	Secs.	Feet per second	Foot-pounds	Feet	Feet	Height	Distance from muzzle
100	0	2.424	0	2.40	0.110+	0	2.570	2,034.25	2,034.25	0.0546	50.9			
200	0	5.152+	0	5.18	.243+	0	5.827+	1,686.80	1,686.80	0.2400+	103.8			
300	0	8.275	0	8.26	.384+	0	9.978	1,392.15	1,392.15	0.5950+	157.52			
400	0	11.831	0	11.83	.693+	0	15.240	1,141.5	1,141.5	1.1681	211.94			
500	0	15.918+	0	15.90	.700+	0	21.937	932.19	932.19	2.0356	270.56			
600	0	20.650+	0	20.68	.899+	0	30.435	762.97	762.97	3.2733	329.47			
700	0	26.104+	0	26.15	1.108+	0	41.137	620.52	620.52	4.9892	390.00			
800	0	32.441	0	32.50	1.340	0	54.543+	513.37	513.37	7.319	452.23			
900	0	39.785+	0	39.86	1.593	1	10.814+	430.37	430.37	10.434	516.13			
1,000	0	48.198+	0	48.30	1.864+	1	29.669	382.36	382.36	14.480	586.70			
1,100	0	57.728+	0	57.80	2.153+	1	59.917	343.02	343.02	19.553	643.60			
1,200	1	8.379	1	8.55	2.458+	2	14.310+	312.60	312.60	25.840	706.6			
1,300	1	20.131+	1	20.35	2.776+	2	39.762	285.23	285.23	33.397	767.3			
1,400	1	32.087	1	33.25	3.108+	3	7.418+	263.85	263.85	42.332	826.76			
1,500	1	46.951+	1	47.26	3.453+	3	37.390+	243.05	243.05	52.778	885.3			
1,600	2	20.38+	2	20.38	3.813+	4	9.745	226.01	226.01	64.838	943.2			
1,700	2	18.272+	2	18.68	4.189+	4	44.621	210.12	210.12	78.670	1,000.9			
1,800	2	35.674	2	36.12	4.572+	5	22.245	169.33	169.33	94.202	1,058.5			
1,900	2	54.277+	2	54.90	4.977+	6	2.746	182.68	182.68	111.163	1,116.3			
2,000	3	14.111+	3	14.70	5.394+	7	46.364	170.46	170.46	131.76	1,174.46			
2,100	3	35.247	5.827+	7	33.479	158.98	158.98	153.98	1,233.2			
2,200	3	57.744	6.277+	8	21.208	148.41	148.41	178.81	1,292.3			
2,300	4	21.664	6.744+	9	18.963	138.64	138.64	206.52	1,352.4			
2,400	4	47.091	7.182+	10	18.230	129.58	129.58	230.58	1,412.07			
2,500	5	14.127	7.734+	11	21.568	121.20	121.20	271.39	1,473.6			
2,600	5	42.850	8.258+	12	30.950	113.63	113.63	309.24	1,535.1			
2,700	6	13.383	8.803+	13	43.750	100.60	100.60	351.13	1,597.3			
2,800	6	45.854	9.370+	15	2.070	546.93	546.93	397.49	1,660.0			
2,900	7	20.404	9.962	16	29.021+	94.28	94.28	448.77	1,723.6			
3,000	7	57.175	10.577	17	59.20	78.02	78.02	595.48	1,787.7			
3,100	8	36.350	11.219	19	36.801	84.07	84.07	568.18	1,852.6			

possible to obtain at any price. It is extremely accurate, and very powerful, especially when used with the special loads described under this cartridge in the chapter on Various Cartridges Discussed.

Appended to this chapter are tables giving the ballistics of the service Model 1906 cartridge adapted to the Model 1903 rifle. For sporting and hunting cartridges adapted to this rifle see the chapter above quoted.

PENETRATION

Material	PENETRATION			
	50 feet	100 yards	200 yards	1,000 yards
White-pine butts made of 1-inch boards placed 1 inch apart.....	Inches 59.98	Inches 52.8	Inches 26.36	Inches 10.48
Moist sand	10.06	14.02	16.1	13.9
Dry sand	6.32	6.88	13.12	10.86
Loam practically free from sand.....	19.9	17.46	23.62	17.46
Thoroughly seasoned oak across the grain	34.19	31.18	14.328
Brick wall	5.5
Low steel (boiler plate)528	.40	.01	.0

RAPIDITY OF FIRE

Twenty-three aimed shots have been fired in one minute with this rifle, used as a single loader, and twenty-five shots in the same time, using magazine fire. Firing from the hip without aim, 30 shots have been fired in one minute, using rifle as a single loader, and 40 shots in one minute, using magazine fire.

MAXIMUM RANGE
(Computed)

Maximum range	Elevation	Time of flight
4,891.6 yards	45 degrees	38.058 seconds

ACCURACY

[As determined by firings to date.]

Range, yards	Deviation		
	Mean vertical	Mean horizontal	Mean radius
	Inches	Inches	Inches
100	0.6	0.6	0.8
200	1.1	1.1	1.5
300	1.7	1.7	2.3
400	2.3	2.3	3.2
500	3.0	3.0	4.1
600	3.6	3.6	5.0
700	4.3	4.3	6.0
800	5.0	5.0	7.1
900	5.9	5.8	8.3
1,000	6.5	6.4	9.6

UNITED STATES RIFLE, MODEL 1917

Prior to the outbreak of the Great War, in 1914, the English Army was equipped with the Lee rifle, a bolt-action, magazine rifle which was officially known as the Lee-Enfield, due to its being made chiefly at the ordnance shops at Enfield. This rifle fired the .303 British cartridge, a cartridge very similar to our .30-40 in shape, size, and ballistics. The rifle itself was rather behind the times. The locking lugs on the breech bolt, instead of being up at the head of the bolt where they would most perfectly withstand the back thrust of discharge, were placed towards the rear end of the bolt. The English ordnance office has considerably improved the ammunition recently by substituting a pointed bullet of 175 grains for the old blunt point bullet of 225 grains,

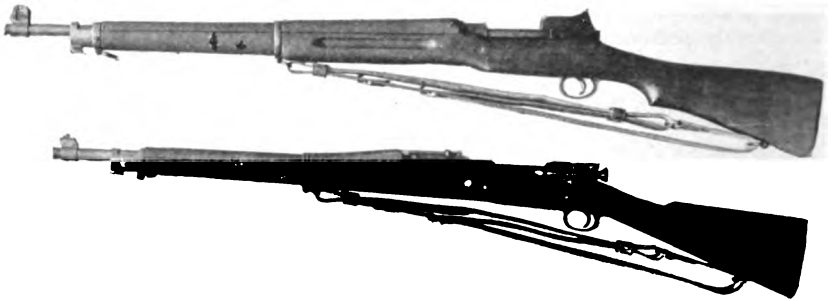

Fig. 25
The United States rifles. View of left side
Upper — Model 1917
Lower — Model 1903

and increasing the velocity from 2000 feet per second, to about 2400 feet per second. Further than this they were unable to go, as the design of the rifle was not such that it would withstand a higher breech pressure. Even with the regular ammunition, the action of the rifle caused many variations in flip and point of impact when conditions were not just right, and considerable pains had to be taken in manufacture to see that each locking lug had exactly the same bearing on the receiver.

In 1913 the English government determined to equip their forces with a more modern rifle using a cartridge with superior ballistics. They selected 28-caliber as being the size with which a bullet of good ballistic coefficient could be fired at the maximum velocity, and yet not have excessive recoil. The velocity was to approach very nearly to 3000 feet per second. A rifle had to be designed to handle this new and powerful cartridge as the Lee was not strong enough, nor was the

receiver large enough. The rifle selected was practically a Mauser. It had the Mauser magazine, bolt, and locking lugs, but the method of cocking, and of compressing the mainspring in the Lee, was retained, as well as the Lee safety lock. Several thousand of these rifles were manufactured, and a few of them issued for trial at the time that the war broke out. England needed at once a large number of rifles; the new rifle was capable of being manufactured more easily than the old Lee. Therefore it was determined to use the new rifle but modify it to use the old ammunition, and accordingly contracts were let in Great Britain and in the United States for the manufacture of this rifle in large quantities.

When the United States entered the war in 1917 it found us with only two arsenals equipped to manufacture the Model 1903 rifle.

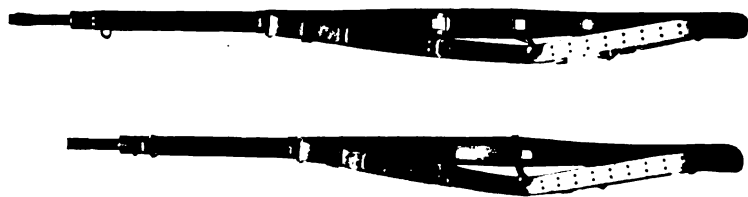

Fig. 26

The United States rifles. Bottom view

Left — Model 1903

Right — Model 1917

Congress at several times had been asked to enter into contract with a number of private arms companies for the manufacture of our rifles, to the end that we might have a number of factories equipped with machinery, gauges, etc., for the manufacture of our 1903 rifles, so that we would be prepared for any emergency like the present one, but they had not seen fit to make the necessary laws and pass the necessary appropriations. Our entry into the war therefore found us with only two arsenals (Springfield and Rock Island) equipped to manufacture our own rifle, but with a large number of factories with machinery all ready to turn out the new Enfield rifle in large quantities. It happened that the Enfield rifle could easily be adapted to our ammunition, the receiver being just about the right size, and the locking lugs amply secure. We therefore entered into contract with all these firms to produce these rifles chambered for our .30-caliber, Model 1906 ammunition with which to equip the National Army, and the result was the United States Rifle, Model 1917.

In its essentials this rifle is really not very different from our 1903 rifle. The bolt and magazine are practically the same. The mainspring, instead of being compressed by a cam during the lifting and shutting of the bolt handle, is compressed partly by the lifting of the bolt handle, but mostly by the last three fourths of an inch of the pushing forward of the bolt, the sear engaging the cocking piece before the mainspring is fully compressed, and holding it back. The safety, instead of being on top of the sleeve, is on the right side of the receiver,



Fig. 27

Rear view of rear sight of the United States rifle, Model of 1917. Leaf laid flat and battle sight in position

in rear of the bridge, and to the right of the sleeve. Bringing the safety lock to the rear to its full extent locks the bolt and trigger by engaging a projection on the cocking piece. The barrel is 26 inches long instead of 23.79 inches, the length of the 1903 barrel. The hand-guard covers the top of the barrel as in the 1903 rifle. The butt-stock is quite a little improvement over our 1903 stock. In the first place it is a little longer. Our 1903 stock was made quite short in an effort to make the whole rifle slightly shorter so that it would suit both infantry and cavalry, and as a consequence it was quite a little too short to fit most men perfectly. The butt-stock on the 1917 rifle also has a pistol grip which permits a better grip for the right hand, particularly leaving the trigger finger more limber and under better control when

the grip is firmly grasped. The 1917 butt-plate is of a better shape to accommodate itself to the shoulder of the rifleman, but it is not roughly checked as is the 1903 butt-plate, and is therefore more liable to slip on the shoulder, particularly during rapid fire.

It is in the sights of the two rifles that we see the most important difference. In making the 1917 receiver the bridge over the bolt well at the rear was made very long, and the rear sight was mounted

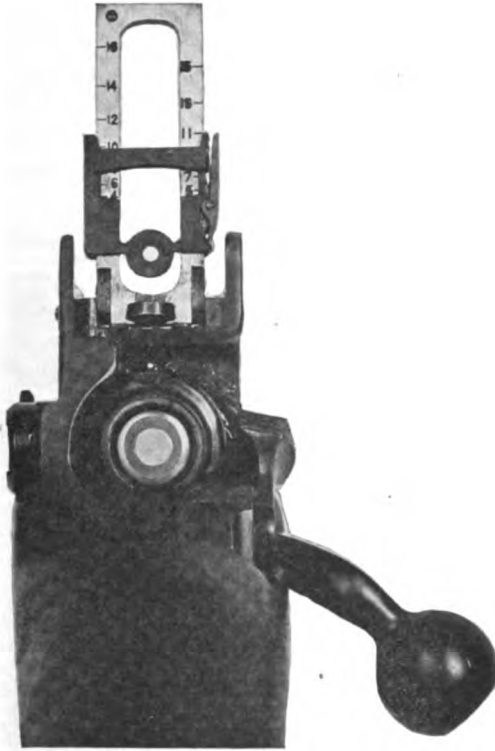

Fig. 28

Rear view of rear sight of the United States rifle, Model of 1917. Sight leaf raised

on this where it should be to get the utmost efficiency. The rear sight is a peep sight, the aperture being on the Lyman principle; that is, a large aperture and a thin rim. The placing of a Lyman sight back close to the eye follows the most modern methods with sporting rifles, and is a great advance in the sighting of the military rifle. There are two rear sights, the standard or battle sight being always in position

and adjusted for 400 yards. In front of this is a leaf which can be raised for longer ranges, and this leaf carries another aperture, also of the Lyman design, which is capable of adjustment from 200 to 1600 yards, but can be adjusted to hundreds of yards only. A ratchet on the leaf slide snaps into serrations on the right side of the leaf, securely locking the slide for every 100 yards of elevation. There is no windage adjustment for the rear sight. On either side of the sight large lugs or projections of heavy metal stand up, fully protecting the sight from damage, either by falls or in the cavalry boot.

The front sight is a straight knife edge, appearing in aiming very similar to our 1903 front sight, but quite a little thicker. It is secured in a dovetail fixed base in a manner almost exactly the same as the front sights on sporting rifles, so that it can be driven from side to

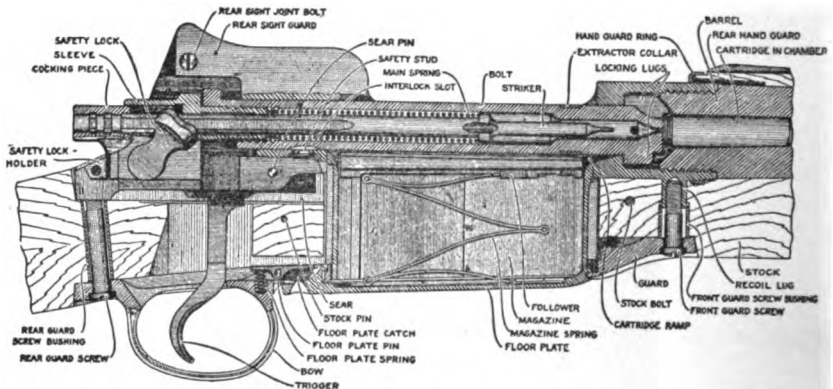

Fig. 20

Breech mechanism and nomenclature of the United States rifle, Model of 1917 side to zero the rifle. On either side of the front sight large lugs or projections of heavy steel stand up, projecting quite a little beyond the top of the front sight, and protect the sight from any damage, or from blows which might knock it out of alignment. The rifleman must learn not to take one of these lugs for the front sight itself, after which he will find no trouble.

Our military target riflemen will probably not take kindly to the 1917 sights as they cannot be adjusted very closely for elevation, and they have no wind-gauge. But these are undoubtedly the best military sights that have ever been placed on a fighting weapon. They permit of a very clear sight, of a very quick sight, and of aim being taken in poor lights. As they do not cut off the vision of the surrounding

country in aiming they lend themselves very well to aim at moving objects, as the object, and its route of travel can be kept constantly in view while aiming. There is also very much less eye strain when using them than there was with the old forms of open and peep sights. The sighting radius is very much longer which adds to the accuracy of aim.

It seems to the writer that the 1917 rifle balances better, and that the stock and the drop thereof fits better than in the 1903 rifle, and if experience proves that the two rifles are made of as good material, and that as much pains have been taken with the 1917 rifle as were taken with the 1903 in providing an accurately bored barrel, we will profit considerably by the change, due chiefly to the more modern sights.

DISMOUNTING AND ASSEMBLING THE MODEL 1917 RIFLE

To dismount the bolt. Remove the bolt from the rifle by drawing it out to the rear while pulling out the thumb piece of the bolt stop. Hook a loop of string on the dismounting hook on the cocking piece lug, and, holding the bolt in the left hand, and the string in the right hand draw the cocking piece out until the lug clears the end of the bolt.

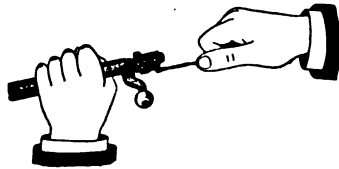

Fig. 30

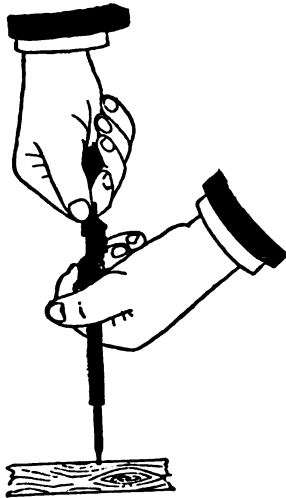

Fig. 31

(See Fig. 30.). Then by moving the right hand in a circular path counter clockwise, four complete revolutions, unscrew the sleeve from the bolt and withdraw the sleeve, cocking piece, and striker from the bolt. Grasp the sleeve with the left hand, and, while holding the point of the striker against a wood or similar surface, force the sleeve towards the point of the striker, compressing the mainspring until the lug on the cocking piece clears the lug slot in the sleeve, as shown in Fig. 31. Then, with the right hand, give the cocking piece a quarter turn, in either direction, to disengage it from the striker, and draw it off to the rear. Relieve the spring from stress slowly and remove it and the sleeve from the striker, being

careful that the parts do not fly from the hand. Turn the extractor so that it covers the gas escape holes in the bolt and push it forward with the thumb until it is free of the ears on the collar.

To assemble the bolt. Slide the mainspring over the striker. Hold the point of the striker against a wood or similar surface, and, placing the sleeve against the end of the spring, with the flats in its bore registering with the flats on the striker, compress the spring by forcing the sleeve toward the point of the striker. Holding the sleeve with the spring fully compressed, replace the cocking piece on the end of the striker and lock it by a quarter turn so that its lug aligns with the lug slot in the sleeve. Then let the sleeve return to its position slowly under the action of the spring. Grasp the bolt in the left hand and start the threads on the barrel of the sleeve into the threads in the end of the bolt. Holding a loop of string in the right hand as before, hook it on the dismounting hook, and draw the cocking piece out. Then by moving the right hand in a circular path, clockwise, screw the sleeve home in the bolt. Place the lug in the half-cock notch. Slide the extractor to place in line with the gas escape holes, engaging the undercut lug on the extractor with the ears on the ring, and lifting the hook so that the tongue will slide over the end of the bolt. Turn the extractor so that it lies over the unslotted or solid lug, and replace the bolt in the receiver, pulling out on the bolt stop, and pressing down on the follower while so doing.

To dismount and assemble the magazine mechanism proceed in exactly the same way as with the United States Rifle, Model of 1903.

CHAPTER V

BARRELS

SOME twenty years ago when black powder was universally used all rifle barrels were made of soft steel or iron. Black powder exerted a pressure of less than 30,000 pounds to the square inch, and nothing stronger was necessary. The main thing was to get a homogeneous metal, and one that would work easily and smoothly. With the advent of smokeless, high-pressure powder and jacketed bullets it was found that an improvement in the barrel steel was absolutely necessary. A higher elastic limit was necessary, greater hardness to resist wear, and a higher melting point to resist erosion of the hot powder gases. A low carbon, easily machined steel was found which would meet these conditions and adopted by the Government for the service rifles. There has been a slight improvement in this steel from year to year, until that now in use is very satisfactory indeed, when erosion, corrosion, machining, and elastic limit are concerned. This same steel is used by practically all commercial riflemakers for their high-power rifles except by the Winchester Company.

On the advent of high-power, smokeless rifles the Winchester Repeating Arms Company adopted a nickel steel for this type of rifle, and have continued to use it to the present day. It has always seemed to me to be a most excellent steel. It is claimed that it has a slightly lower melting point than the ordnance steel used by the United States Government, and that therefore it does not resist erosion as well. My own experience with it has been just the opposite. It seems to resist erosion much better than the other steel, and it certainly is quite a little more resistant to rust. I have one .30-40 barrel of this nickel steel made in the spring of 1906 that has been fired many thousands of rounds, I would hate to say how many, with every kind of ammunition and powder, and as far as I can see the barrel is just as good as ever and shows no signs of wear. During the time that I have had this rifle I have worn out six barrels of Krag rifles, and this one nickel steel barrel has certainly had as many rounds fired through it as all six Krag barrels combined. But this is probably an exceptional

case, and an exceptional piece of steel, and too much notice should not be paid to this incident.

Of late years a few riflemen in this country have imported steel from abroad and had barrels made of it. The German Krupp hard steel makes very good barrels, but I do not believe that it is a bit superior to our own steel for rifle barrels. About 1911 Mr. E. C.

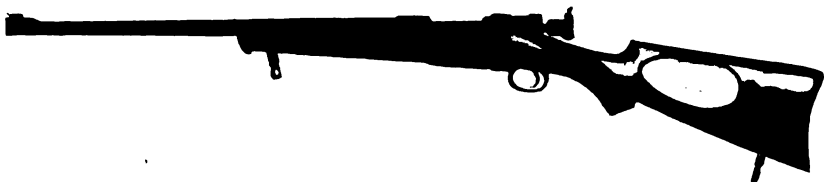

Fig. 32

Sporting Springfield rifle used almost exclusively by the author as a hunting rifle from 1913 to 1917. This rifle has a Poldi "Anti-corro" steel barrel, and has proved a most efficient hunting arm.

Crossman and the writer both imported from the Poldi Steel Works in Vienna, Austria, barrels of what is known as Poldi anti-corro steel, which had attracted much attention abroad on account of its resistance to rust and erosion. We both had these barrels rifled and chambered for the .30-caliber, 1906 cartridge, and we have used them considerably since. Our experiences with them have been practically identical. This is a very tough, hard steel, and has been used quite a little in this country by mechanics for steel working tools. It was so hard that when I sent my barrel to the Springfield Armory to have it chambered and fitted to a Model 1903 action the mechanics there broke four chambering tools in chambering it, and I had to pay the bill. I find that this barrel has a much greater resistance to rust than ordinary steel, or even nickel steel. I used this rifle for three years in Panama, which is probably the greatest rust-producing country in the world, the dampness there being beyond belief. This rifle was out with me in the jungle almost all the time. I noticed particularly that it never had a speck of rust on it, while other barrels would always accumulate quite a respectable coating of rust on the muzzle where there is no bluing, in the course of a day's hunt. To leave a barrel of ordinary smokeless steel, using the .30-1906 cartridge, uncleaned over night when it has been fired means plenty of red rust in the morning, but the anti-corro steel treated in the same way showed absolutely no rust the next day. Moreover, I have often found rust in smokeless steel barrels a week or so after they have been fired and

apparently perfectly cleaned, but periodical inspections of my anti-corro barrel have never shown a particle of rust. This barrel is such a good shooting one that I have never abused it to see just how much it would stand without developing rust. I know it will rust eventually because I was once upset with it when 'way out at sea on an uninhabited coast in a dug-out native canoe, and the rifle was under salt water for several hours. I dismantled the rifle entirely and wiped it off well, but there was evidently one spot under the wood of the forearm that I overlooked, and on dismantling it several months later I found quite a little coating of rust in a spot about as big as a ten-cent piece. I have only fired this barrel about 500 rounds, not enough to show any signs of erosion, but on account of its extreme hardness I would expect it to resist erosion better than our own steels. Mr.



Fig. 33

Floor plate of Springfield sporting rifle owned by the author, showing engraving and coat of arms

Crossman in discussing this steel says: "It is not always possible to care for a rifle barrel as per schedule, and there are times, as any experienced hunter knows, when one is so dog-tired, and so ready to crawl into the blankets and rest the weary muscles and aching bones, that one does not give a fig for what happens to the dog-goned rifle that weighed fifty pounds when dragged back to camp that evening. It is for such occasions that we of experience get when we can, Poldi barrels." Of course these barrels cannot be obtained at the present time. I consider myself lucky to have a barrel of this excellent steel, and the rifle has been my favorite hunting arm for the past four years. It is shown in Fig. 32.

An enormous amount of experimenting has been done with a view to determining the best shape and design for the lands and grooves of the barrel. Invention has run riot in this respect. There have been produced barrels with all number of grooves from two to sixteen, with rectangular, "U" shaped, triangular, and rounded grooves, and even with a simple oval bore. Of recent years the ordnance departments of various nations have had facilities to test to the fullest extent all these different forms of rifling, with the result that they have determined that the difference between most of them as far as accuracy,

wear, and resistance to erosion are concerned is microscopic. Practically all nations and manufacturers have adopted a rifling with square corners to the grooves and lands, and with either four or six grooves. In .30-caliber, which is the average caliber, the grooves are usually made about .004 inch deep. The grooves are almost always of an even number as it has been found easier and cheaper in manufacture to cut two grooves at a time, but undoubtedly a more perfect barrel can be cut by cutting only one groove at a time, this being the method used by Mr. H. M. Pope, who produces the finest handmade barrels in the world. Perhaps the best form of rifling is one with square upper corners to the lands, but with slightly rounded lower corners to the grooves as shown in Fig. 34, "A" being the ordinary rifling as used by most governments and manufacturers today, and "B" being this

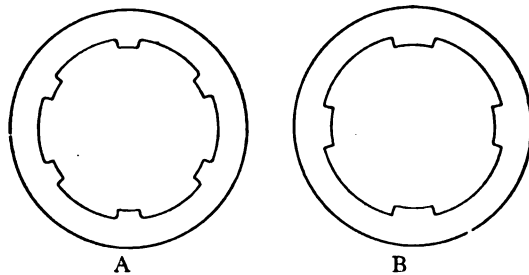

Fig. 34

A. Pope special high power rifling. B. U. S. Government rifling.

special rifling. It is claimed that the stiff jacket of the bullet will not adapt itself to a perfectly square corner at the bottom of the groove, and that a little gas always escapes here. As proof of this rifles cut with the special rifling show a few feet more velocity than those cut with the ordinary rifling. Recently one manufacturer has adopted a segmental cut for his rifling, practically a double oval bore, with rounded grooves and lands, claiming less wear, easier cleaning, and not so much strain on the bullet jacket. Undoubtedly he gets the last two, but the writer believes that more wear and friction must result through the tendency of the bullet to creep up and jam to a certain extent on the rounded driving edge of the groove.

The twist of the rifling in American arms varies from one turn in 60 inches to one turn in $7\frac{1}{2}$ inches. The longer the bullet in respect to its diameter, the quicker the twist must be in order to maintain the gyrostatic stability of the bullet during flight; that is, to keep it from

flying point on, instead of turning over and over. Also, the higher the velocity of the bullet the slower the twist may be. For example, the twist of rifling for the .50-100 Winchester express cartridge, which has a very short bullet in relation to its diameter, is only one turn in 60 inches, while the twist of rifling for the .30-40-220 cartridge, which has a very long, small caliber bullet, is one turn in 10 inches. There used to be quite a little difficulty with the .25-20 cartridge in the days of black powder in keeping the 86-grain bullet flying point on. Many bullets would turn over, and pass through the target sideways, making a keyhole shot, so called because the shape of the hole in the target resembled a keyhole. But with the introduction of smokeless powder it was possible to load enough smokeless powder in the small shell to increase the velocity enough to overcome this tendency to keyhole.

A poorly chambered barrel, or poor ammunition and bullets, require a quicker twist than when the conditions of barrel and cartridge are conducive to accuracy. Thus ordinarily the various .30-caliber United States Government barrels require a 10-inch twist to get the best results, but with the fine hand-made barrels of this caliber as made by Mr. H. M. Pope, a 14-inch twist gives perfect results up to 1200 yards at least. It often happens that the twist of rifling given to a certain barrel by a manufacturer is sufficient to keep the bullet flying point on up to a certain range, but after that range is passed there is a tendency to keyhole because the velocity has been reduced. Tendency to keyhole with any rifle can be overcome by either increasing the velocity, or shortening the bullet, or providing more perfect bullets, provided that this tendency is not caused by faulty chambering of the barrel or defect in the rifling. Occasionally one sees a .22-caliber, rim-fire barrel which persists in keyholing its bullets, and when the cause is investigated it is found to be due to a very dirty bore, or to one very badly leaded. Some riflemen think that it is best to use the slowest twist that will spin a bullet perfectly. Certainly a slow twist requires very perfect ammunition to do good work, and perfect chambering too. I would rather have a twist a little quicker than ordinary so as to handle possible defects in ammunition. Quick twists of course cause more friction, heat, and consequently more wear on the bore.

Formerly the most popular barrel was the octagonal, or eight-sided one. The only possible excuse for such a barrel was that it could more easily be held level; that is, it helped to overcome any tendency to cant, or lean the rifle in aiming. As against this the octagonal barrel is more difficult to make than the round barrel, and it is more liable

to be disfigured on its exterior by blows and cuts. But more important than these, the metal in such a barrel is not uniformly distributed around the bore; there is unequal expansion when the barrel becomes heated, and there is not such a uniform flip or vibration on discharge. Also for a given strength of barrel, the octagonal barrel weighs more than the round. Octagonal barrels are now practically obsolete, being seen only on the older models of tubular magazine rifles.

A heavy, thick barrel will always give better results than a thin taper one. It shoots more consistently, and it maintains its elevation better from day to day. Also it is not so much affected by slight differences in the load, and for this reason alone it is more accurate than the thin barrel, particularly at short ranges, where the difference in velocity does not enter into the matter so much. A thick barrel will also frequently shoot both full-charged and light gallery or small game loads with practically the same elevation and windage at short ranges, and this is a decided advantage to the hunter, and to those looking for an all-around rifle. But of course a thick barrel greatly increases the weight of the rifle, and makes it muzzle heavy. The heaviest barrel now made is the No. 3 barrel for the Winchester single shot rifle, but formerly this rifle used to be made to order with No. 4 and No. 5 barrels, a No. 5 barrel, 30 inches long, making a rifle which weighed about 15 pounds. The Winchester single shot rifle with No. 3 round barrel, 30 inches long, weighs from 9 to 9½ pounds according to caliber, and is a very muzzle-heavy rifle. I regard the barrels furnished for the Model 1895 rifle in .30 Model 1906, .35 W. C. F., and .405 W. C. F. calibers as being almost ideal in their exterior proportions. These barrels are 24 inches long, rather thick at the breech, with a straight even taper to muzzle. They present just about the right combination of stiffness with the modern requirement of light weight.

Many barrels have slots cut in them for sights, and also usually a slot cut on the under side of the barrel for securing a base to which the forearm screw is fastened. There is no excuse for any of these slots. They take away from a barrel much of its stiffness, and increase the flip or vibration which takes place during firing. There is no use at all in providing a heavy stiff barrel in the effort to increase accuracy, and then allowing the manufacturer to defeat the whole idea by cutting on the under side of the barrel a big, deep slot simply for the purpose of dovetailing a base into the barrel to screw a forearm screw into, when he could with much less expense and trouble screw the screw into the barrel in the first place and avoid the slot.

The muzzle of the barrel flips, vibrates, or bends down and then up when it is fired, and usually the flip is greater the more powerful the cartridge. The character of the flip is such that even at short ranges where the velocity does not count for much the more powerful a cartridge is the higher will it strike on the target, because it departs from the muzzle when the rifle barrel towards the muzzle is at a higher point in its vibration. Light and heavily charged cartridges do not have the same starting point when fired from the barrel. This is explained fully in Chapter XIX. There are some exceptions to this rule that the stronger charge strikes higher, and the Ross Rifle Company have taken advantage of this fact in designing the barrel for their .280 rifle, and this explains the peculiar taper of the Ross .280 barrel at the breech. The idea is so to arrange the vibrations of the barrel that the low velocity cartridge will depart from the muzzle at a higher point in the vibration than does the higher velocity cartridge. Thus the company attempts to nullify the effect of the small differences in velocity which are always found in all ammunition, making the low velocity cartridge depart from the muzzle with a slightly greater elevation than does the high velocity load. By this is not meant full-charged and short-range cartridges, but two cartridges, we will say, one giving 3030 feet per second and the other 3050 feet per second velocity.

It would seem that the details of chambering properly come under the head of barrels, but the matter of chambering is so intimately connected with accuracy that I have been forced to deal with it in the chapter devoted to that subject. The accuracy of a barrel depends upon the correctness of its design, and the accuracy of workmanship. Luck has nothing to do with it, except that among a number of poor barrels one may happen to be accurate because, entirely by accident, it happened to be made nearly correctly. Following the lead of Dr. Mann, riflemen have come to call an extremely accurate barrel a "gilt-edge" barrel. I would call such a barrel one that is capable of delivering ten consecutive shots within a one-inch circle at 100 yards, or a 2½-inch circle at 200 yards. Such accuracy is practically impossible with machine-made barrels, because about the closest such workmanship can be executed is within .001 inch. Pope barrels are almost always gilt-edge barrels because Mr. Pope has the rare skill of being able to finish his work within .0002 inch of being perfect. In fact I personally know of one barrel which he made for Dr. Mann, on which he performed a certain piece of work to within .0001 inch.

CHAPTER VI

STOCKS, FOREARMS, BALANCE, AND WEIGHT

THE stocks and forearms of the ordinary factory-made American rifles are made of American walnut. This wood makes a very satisfactory stock, strong and of fair appearance, but it has not the figure, nor will it take the polish, of the imported stocks. Our selected stocks are made from European walnut obtained for the most part in the southeastern part of France. It is called by the trade "English walnut," but practically none of it is grown in England, although I believe we import it from English dealers. English walnut is simply a trade name to designate a finely figured variety suitable for the better gun stocks. Italian walnut is heavier than French, is not so bright in color, has plenty of dark veins, but the background is one hue instead of having the yellow, orange, and neutral tints of the finest woods. Circassian walnut furnishes the very finest stocks, but it is seldom seen in this country. It is hard in grain, full of figure, exact in marking, bright in color, without cracks and galls. It is quite heavy, but has qualities which quite outweigh this disadvantage. The most beautifully marked stocks are cut from the portion of the tree where the roots and trunk join. The wood should be seasoned for at least a year in a dry storehouse without artificial heat before being made up into stocks. It should be so selected and cut that the grain at the grip is always straight so as to give the necessary strength at the weakest part.

Stocks are sometimes made of beech, bird's-eye maple, cherry, and tulip wood, but all these are inferior to walnut. Bird's-eye maple used to be used quite extensively for rifle stocks, particularly on muzzle-loading Kentucky rifles. It makes a nice looking stock, but it is too brittle, and requires varnish to give it a good polish.

The cheaper stocks are simply smoothed and varnished. This method of finishing is best suited to American walnut which, as a rule, does not take a good oil polish, but a varnished stock does not retain its good appearance long when in use. It becomes scratched and unsightly very quickly from ordinary field use. By far the best polish

is what is known as dull London oil finish. It consists in smoothing down the wood very finely, repeatedly wetting the surface to raise the grain, and then polishing again, until finally a surface is obtained on which the grain will no longer raise up with a fuzzy surface when it becomes wet. The stock is then polished by repeated rubbing with raw linseed oil, each coat being rubbed in by hand until the surface is dry. The finest stocks sometimes have as many as thirty coats rubbed in, and the process takes several weeks to complete. This gives a beautiful polish which brings out all the grain of the wood, and makes a smooth, velvet-like surface, without the glassy shine of varnish, but with the beautiful dull luster of pumice-rubbed mahogany. This polish persists in spite of rain, perspiration, and scratches; moreover, it may always be renewed practically as good as new by simply rubbing in a coat of raw linseed oil, placing a little of the oil in the palm of the hand and rubbing it well in until the stock becomes warm from the friction, and the surface becomes dry.

It is a decided advantage to have the grip of the stock and the center of the forearm checked, as this adds to security in holding, particularly in warm climates where the hands are slippery with perspiration, and in cold climates where gloves are worn. Good checking also adds to the appearance of the arm. The checking should not be too fine as it will defeat its purpose, that of keeping the hands from slipping. Nor should it be too coarse as it will then not look well. The size of check used on Winchester rifles is about right. Plain checking with a plain border looks best. Fancy carving is out of place on a rifle, savoring too much of the cheap and gaudy.

Wherever the receiver will permit of it, the stock should have a pistol grip. This is a great aid to steady holding, and to the quick operation of the rifle in rapid fire. The right hand should do most of the work of holding the rifle to the shoulder, leaving the left hand without strain to point and direct the rifle. If there be no pistol grip, either the right hand must grasp the small of the stock unduly hard to pull it back against the shoulder, thus interfering with the flexibility and unrestraint of the trigger finger, or else the left hand must grasp the forearm hard to pull the butt back against the shoulder, in which case it will be under strain and will not be able so well to hold the rifle steadily and without tremor.

When purchasing a new arm, if the rifleman is able to afford extras over the ordinary factory product, the one which will pay most is a hand-made stock built to fit him personally. A well fitting stock is

more important than fine walnut, checking, or pistol grips, but as a rule it is only the expert rifleman who appreciates this. The fitted stock insures steadier holding, makes the rifle come to the shoulder almost perfectly directed at the mark, and thus increases the rapidity of fire, particularly the rapidity with which an accurately aimed first shot can be gotten off. When a rifleman has a stock which fits him perfectly he will find after a time that he becomes so used to his rifle, and to the instinctive pointing of it, that he can do good shooting even at night when he cannot see his sights.

Very little attention has been given to the fit of stock by American manufacturers, but there are a few private gunmakers in this country who have the art down to perfection. The ordinary factory stock is either much too short, or else it is too straight for the average man. Factory stocks are supposed to fit the average man, but constant experimenting on a great number of men with stocks of all dimensions for the past ten years has convinced me that they are far from correct. As a rule they are suitable only for men with very short arms, and thick, short necks.

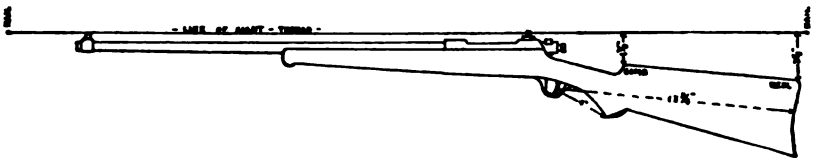

Fig. 35
Showing method of measuring a stock

To measure a rifle stock, lay the rifle on its side on a board floor. Place a long nail in the floor a foot in front of the muzzle, and another a foot in the rear of the butt. Stretch a thin thread tightly from one nail to the other at such a distance above the floor that the thread will be at the same height as the front and rear sights. Carefully bring the rifle sights up against the thread so that the tip of the front sight, and the middle of the notch of the rear sight (or the center of the peep hole of the rear sight), just touch it without forcing it out of a straight line. This thread now marks the line of sight. Measure the distance at right angles to the thread, from the thread to the comb of the stock, and from the thread to the heel of the stock. Measure the distance from the middle of the trigger to the middle of the butt-plate. Figure 35 shows the method. The average dimensions of factory stocks are as follows:

WINCHESTER STOCKS

Length from middle of trigger to middle of butt plate.....	13 $\frac{3}{4}$ inches
Drop from line of sight to comb	2 inches
Drop from line of sight to heel	2 $\frac{3}{4}$ inches

SAVAGE STOCKS

Length from trigger to middle of butt plate	13 inches
Drop from line of sight to comb	1 $\frac{1}{8}$ inches
Drop from line of sight to heel	3 inches

Experience has shown that the following dimensions more perfectly fit the average American:

Length from middle of trigger to middle of butt plate.....	13 $\frac{3}{4}$ inches
Drop from line of sight to comb	1 $\frac{1}{8}$ inches
Drop from line of sight to heel	3 $\frac{1}{8}$ inches

The small man will do a little better with a length of 13 $\frac{1}{4}$ to 13 $\frac{1}{2}$ inches, and a drop at heel of 3 inches, and the very tall man with a length of 14 inches, but other dimensions the same.

It is a difficult matter for the novice to tell whether a stock fits him correctly or not. He must first learn the various firing positions, and have some actual experience in shooting. Really, a man is not in position to tell whether a stock fits him until he has been shooting for several years. To determine whether the stock fits correctly, take the rifle and throw it up to the shoulder several times, so that the butt-plate is perfectly fitted to the hollow of the shoulder, being neither too high nor too low. Do not aim at anything in particular. If it seems to come up easily to the shoulder and to be in perfect control, select a mark ten or fifteen feet distant, and at about the height of the shoulder. Throw up the rifle quickly, while *looking only at the mark*, the cheek snuggling down to the left side of the stock. Hold the rifle still, close the left eye, glance through the sights, and see if they are directed close to the mark. Repeat this a number of times, and if it is found that the sights come close to the mark each time, with no tendency to be either high or low, that the eye seems to be led each time directly into the line of sight by the comb, and that the butt-plate comes up easily to the shoulder, just escaping it on coming up, and having to be brought back the minimum distance against the shoulder, and that it sticks well there, the stock probably fits all right. If the sights point much below the mark the stock is either too crooked, or too short, or the rifle may be very muzzle heavy. If the sights point above the mark the stock is too straight, or else the toe of the stock is too far to the rear, the butt-plate being set at the wrong angle.



Fig. 36

An "under and over" combination rifle and shotgun made for the author by Fred Adolph of Genoa, N. Y. Top barrel 20 gauge shotgun. Under barrel .30-30 W. C. F. rifle. An excellent all around arm, particularly for South American shooting.

It is almost always best to purchase the rifle with the cheapest factory stock obtainable, and, after having sighted the rifle in, proceed to alter the stock roughly by padding or cutting down the comb, and by altering the position of the butt-plate, and padding under the butt-plate to obtain the right length of stock, until the makeshift seems to fit correctly. There is a reason for proceeding in this way. The line of sight from which the manufacturers seem to measure their stocks apparently is fixed arbitrarily, or else measured only from the regular factory sights, and when one places special sights on the rifle the line of sight, and consequently the drop, changes. Thus the dimension of the Savage factory stock is given above, but I found that when I had adjusted special Lyman sights to one of these Model 1899 rifles and sighted it in correctly at 50 yards the drop of the stock became: Drop at comb $2\frac{1}{4}$ inches, drop at heel $3\frac{1}{2}$ inches. When the rifle is correctly sighted the gunmaker can construct a stock to have the exact drop desired, but until this is done it is much a matter of guess work as to just where the line of sight is coming.

The dimensions of the pistol grip are of importance also. On a num-

ber of rifles the so-called pistol grip is merely an excrescence some distance in rear of the grip, and of no use at all. The pistol grip should be well curved, and pushed up close to the trigger. The distance measured from the middle of the trigger to the front edge of the pistol grip cap should be between 4 and $4\frac{1}{2}$ inches. On many rifles, however, the finger lever or the lower tang limit the position of the pistol grip, and the grip will have to conform.

It is an advantage to have the stock made with a slight "cast off"; that is to say, the butt-plate, instead of having its center in a vertical

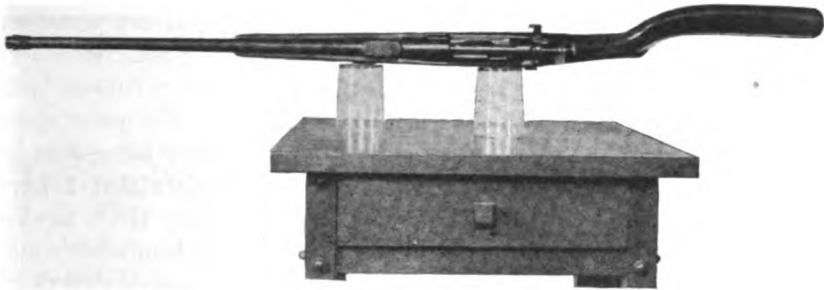

Fig. 37

Springfield rifle remodelled by A. O. Neidner with stock for owner who shoots right handed but aims with the left eye

line dropped from the prolongation of the axis of the bore, should be slightly to the right of this line (for a right-handed shot), say about $\frac{1}{4}$ inch. This will make it easier for the right eye to get into the line of sight. Cast-off is particularly good where the rifleman is stout, or has a very muscular shoulder and chest, and in some cases it is best to have a little more cast-off at the toe of the stock than at the heel.

The butt-plate is an important part of the rifle. There is very little excuse for the rifle butt-plate often seen on American rifles. It is a relic of the muzzle-loading days when the rifle had a very heavy, long barrel, and something to prevent the stock from slipping up on the shoulder due to the leverage exerted by the heavy muzzle was desirable. Lately some have claimed that they like it with lever-action rifles because it seems to stick well to the shoulder when the lever is worked in rapid fire. There is some excuse for it, perhaps, from this standpoint, as the ordinary, flat shotgun, rubber butt-plate slips badly when rapid fire with the rifle at the shoulder is attempted, but the more modern steel butt-plates, especially the particular one to be described, do not have this fault. The rifle butt-plate greatly increases the effect

of recoil, is hard to get quickly to the shoulder, does not adapt itself to the shape of a man's shoulder, and is very prone to stick to the shoulder. In selecting a new rifle it should never be chosen.

Likewise the rubber butt-plate often seen on rifles, and particularly the boy-sized, rubber butt-plate often seen on rifles produced in later years, is to be avoided. Its shape is bad, it is slippery, and it won't last any length of time at all under the usage that a rifle receives. Particularly in mountainous countries it is absolutely necessary at times to use the butt of the rifle as an aid to climbing, especially in rock work. This will scar, disfigure, and break a rubber butt-plate in a little while. On one trip in Montana I noticed that every rubber butt-plate that I saw was broken from this cause. A good checked or roughened steel shotgun butt-plate costs no more than a rubber butt-plate, and should always be chosen. The Winchester Company make a very good checked steel, shotgun butt-plate which they furnish at no extra cost on special order. By far the best butt-plate that I have ever seen, and the one which I have adopted for all my rifles, is that furnished on the Mannlicher-Schoenauer rifles imported into this country before the war. It is a shotgun butt-plate of steel, roughly checked, and rounded so as to fit the shoulder perfectly. Moreover, it is very slightly hollowed so that it sticks to the shoulder most perfectly, either with lever or bolt-action rifles when the mechanism of the rifle is worked in rapid fire. It has a trap door in it so that recesses can be cut in the stock under the butt-plate for field cleaner, small oil can, a few cleaning patches, and a broken shell extractor. The rifle illustrated in Fig. 32 is equipped with one of these butt-plates. It cannot be had at the present time, but I am in hopes that in the near future at least one factory or private gunmaker will see the light and place it on the market.

The butt-plate should always be placed on the stock at a very slight angle, the toe of the butt-plate being just a little farther forward than the heel. This keeps the butt from slipping downward when the rifle is at the shoulder, particularly in rapid fire. With the modern, properly balanced rifle the tendency of the butt-plate is always to slip down on the shoulder instead of up. Some American rifles have the butt-plate placed on at just the opposite angle to this, and it is a confounded nuisance, particularly with a lever-action rifle.

A cheek piece is a slight advantage on a rifle stock, and many riflemen think that it adds considerably to the appearance of the stock. Undoubtedly it helps to accustom the cheek always to find the same

position on the stock each time, thus enabling one quickly to get the eye into the line of sight. Most cheek pieces have sharp edges, and these quickly become dented and broken down, thus greatly disfiguring the rifle. The cheek piece designed by the author has a rounded edge which gives a very fine appearance, and is free from this fault. After nine years in mountains and jungle this cheek piece shown in Figs. 20 and 32 still retains its good appearance. If a cheek piece is added to the stock the butt should have a little more cast off than when the stock is without this addition. A cheek piece is a good thing to improve the balance on a rifle that is a little muzzle heavy, as most of our repeating rifles are.

I am a great admirer of the standard forearms as made on the Winchester repeating and single-shot rifles. Their shape, size, and location is just about right, both from the standpoint of utility and looks, and the rifleman who has a forearm made to order cannot go far wrong in adopting the Winchester forearm as a model, particularly those on the fancy models of the Model 1886 and 1895 rifles. The location of sling swivels on stock and forearm is covered in Chapter XXV.

A rifle should be well balanced so that it comes up to the shoulder easily and quickly, so that it feels lively in the hand and not like a lump of metal and wood, and so that it is easily carried on the shoulder and in the hand. Balance is a hard thing to explain on paper. It is a thing rather to be appreciated only by feel. A properly balanced rifle feels lighter than it is, and is easily handled. A poorly balanced one is clumsy and slow. When balanced across a sharp edge, such as a ruler, the rifle should balance at a point four or five inches in front of the trigger. Most American rifles balance quite a little in front of this point, very little attention being paid to this detail by our manufacturers. The majority of our rifles are muzzle heavy, particularly the tubular magazine repeaters having full magazines and rifle buttstocks. A little muzzle heaviness does not hurt much; in fact, it makes a rifle a little steadier to hold in deliberate fire, and for this reason Schuetzen target rifles are always made quite muzzle heavy. But if the hunting rifle is too heavy at the muzzle it is difficult to bring it into alignment quickly, and hard to swing it in aiming at moving game.

The exact point of balance is not everything by any means. There must also be a nice proportion of weight between barrel, action, and stock. Some rifles balance at the right point, but their receivers and

actions are so heavy that they are decidedly breech heavy and clumsy. The Winchester Model 1895 and the Remington auto-loading rifles are particular offenders in this respect. One of the best balanced arms that I know of is the Winchester Model 1886 rifle when made with a 24-inch, .33-caliber barrel, half-magazine, pistol grip stock, and shotgun butt-plate. Springfield rifles when remodelled into sporting arms by a good workman can be made to balance perfectly, and as the actual balance comes almost in the middle of the magazine, the balance persists no matter how many cartridges are in the magazine. Of course the balance of a tubular magazine rifle changes constantly according to the number of cartridges in the magazine. If the cartridges be heavy, and the magazine a full length one, the rifle is extremely heavy and handles badly when the magazine is full, but there is little difference in the balance of a half magazine no matter how many cartridges are in it, unless the cartridges are very heavy.

American big game rifles weigh from about 9 pounds for the heavier arms to about 6 pounds for the lighter ones when made up in carbine style. Certain models are made in "featherweight" style with very thin barrels, but these are not advisable, and if the sportsman is after light weight arms he had better adopt a carbine than take one of the very thin barrel models as the shooting will be much more reliable. It is possible to cut down the weight of our rifles considerably by hollowing out the stock, and removing excess metal from certain of the parts, including the receiver, but the rifleman had better entrust such jobs to a very skilled gunmaker, otherwise he is liable seriously to weaken the rifle, and even rob it of its margin of safety. The ideal weight for the big game rifle is about $7\frac{1}{2}$ pounds, except for the very heaviest calibers which often need a weight of almost $8\frac{1}{2}$ pounds. Of course the lighter a rifle the more it recoils theoretically, but actually balance and fit of stock have so much to do with the feel of the recoil that it is possible so to model a $6\frac{1}{2}$ -pound rifle that the recoil will not be felt as much as a poorly fitting one of 9 pounds firing the same cartridge. Other things being equal, of course the heavy rifle will tire a sportsman more on a long day's hunt, but here balance and fit also enter, and in many cases a poorly balanced rifle of 7 pounds weight will tire one more in the course of a day over hard ground than a 13-pound, double-barrelled English elephant rifle of superb balance and design.

On the other side of the fence, most of our .22-caliber, rim-fire rifles, particularly the repeaters, are entirely too light and small. The

whole rifle seems to be boy sized, and there is certainly a demand in our market for a decent sized, .22-caliber, repeating rifle with full-sized stock weighing about $6\frac{1}{2}$ pounds, and being so made that adjustable sights can be fitted to it. At the present time the only man-sized, .22 rifle on the market is the Winchester single shot.

CHAPTER VII

THE SIGHTS

SIIGHTS are placed on all rifles for the purpose of enabling one to aim accurately. As the rifle fires but one projectile at each shot it is essential that the aim be much more accurate than with a shot-gun, where the top of the barrel is merely brought into approximate alignment with the object it is desired to hit. To aim any long object, like the barrel of a rifle, it is of course necessary to have two guides or sights which can be brought into the straight line from the eye to the center of the target. This line is called the "line of sight." The two guides or sights are called the *front sight* placed on top of the barrel near the muzzle, and the *rear sight* placed either on top of the barrel a few inches in front of the breech, on top of the receiver, or secured to the top of the tang. These two sights are aligned by trial (that is, made high or low, and moved to the right or left) so that when they are brought into the line of sight and the rifle fired the bullet will strike the center of the bull's-eye at the farther end of the line of sight.

There are an endless variety of sights, from the simplest forms to the most complex. We may divide them into two general classes; *iron sights* and *telescope sights*. The former are the metallic sights, always two in number, front and rear, usually seen on rifles, and familiar to any one who has handled a rifle. The latter are small telescopes secured to the barrel of the rifle by adjustable mountings. They contain cross-hairs similar to those in the telescope of a surveyor's transit, aim being taken by looking through the telescope at the magnified image of the target, and getting the cross-hairs to intersect where one wishes his bullet to hit. Telescope sights are dealt with in a subsequent chapter.

The simplest forms of iron sights are known as *open sights*. The front sight consists of a thin blade of metal affixed to the top of the barrel directly over the center of the bore, near the muzzle, with one edge towards the breech. The rear sight is generally placed on the top of the barrel a few inches forward from the breech. It also con-

sists of a blade of metal, but is placed with its flat side toward the breech and eye. The top edge usually contains a "V" or "U" shaped notch at the center. See Fig. 38.

The act of aiming with open sights consists in so aligning the sights and the target that the front sight appears in the notch of the

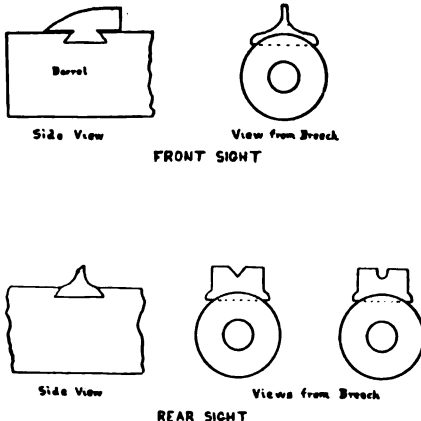

Fig. 38

Common American front and rear sights, showing method of attachment to the barrel

rear sight, and a prolongation of this alignment strikes the target as shown in Fig. 39. The accuracy of aim depends upon aligning the sights exactly the same each time. For example, the blade of the front sight must always appear exactly in the middle of the notch of the rear sight, and the top of the front sight must always appear exactly the same distance above the bottom of this notch. The accuracy with which this can be done time after time depends upon the ability of the eye of the individual to align objects, and accurately to measure and compare small objects by eye. This sense of proportion varies with individuals, and thus the accuracy with which each can aim differs. Accurate aiming may be said to consist of impressing on the retina of the eye by constant practice a memory of the view or "picture" of the sights and target correctly aligned, and then the careful alignment so that this picture appears to be exactly duplicated each time aim is taken.

It has been found that while individuals soon acquire a considerable degree of accuracy and expertness in aiming, yet there is always a certain amount of error, and that with open sights the differences

in light will cause an appreciable difference in alignment even when the picture appears correct. It has also been found that the eye is capable of centering objects with much more accuracy than it is of producing an alignment similar to getting a front sight exactly the

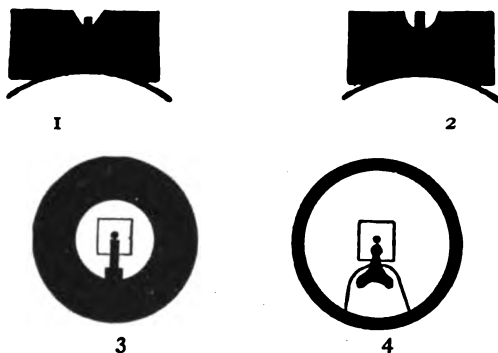

Fig. 39

Method of aligning sights

1. English "V" open express sight.
2. Open "U" sight.
3. Target peep sight with cup disc
4. Lyman peep sight

same every time in the notch of a rear sight. This has led to the perfection of another form of iron sight called the *peep sight*, the rear sight consisting of a small round aperture in a plate, or of a sort of ring. With peep sights the act of aiming consists of getting the front sight to appear with its top exactly in the center of the peep hole, and then moving the rifle so as to bring the target into this alignment. The natural aptitude of the eye for centering objects enables one to do this with considerable accuracy. Fig. 39 shows this method of aiming, 3 being the ordinary peep sight usually seen on target rifles, and 4 being what is known as the Lyman system. In both cases the peep hole appears quite large. It looks large as shown in the figure when the eye is held near to it in aiming, but as a matter of fact the exact size of the aperture illustrated in 3 would probably be .05 inch diameter, and with the Lyman system the peep hole is about .10 inch in diameter. The Lyman sight, as will be seen, permits of an almost unimpeded view of the target during aim, and for this reason it is easier to align quickly, particularly on a moving target, and it can be used in darker lights than most sights. The Lyman peep sight is usually seen on hunting rifles.

As we have seen in Chapter II, the bullet begins to drop the instant

that it leaves the muzzle of the rifle. The sights can therefore be adjusted or aligned for only one range at a time. Thus if the sights are adjusted so that the bullet, when fired, will hit the bull's-eye at 100 yards, the bullet will leave the muzzle under the line of sight, and travelling slightly upward, it will cross the line of sight a few yards in front of the muzzle, and will continue to rise above the line of sight up to a point a yard or two more than half way to the 100 yard target (say 53 yards), and will then fall toward the line of sight until at the target 100 yards from the muzzle it again falls into the line of sight by striking the center of the bull's-eye. With the sights adjusted correctly for 100 yards, and with aim taken at the center of the bull's-eye, it will be apparent that if the target be 50 yards away the bullet will be travelling above the line at that range, and hence it will strike the target above the bull's-eye. And if the target be at 200 yards instead of at 100 yards, the 100 yard sight being used, the

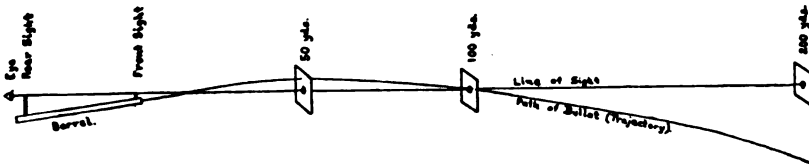

Fig. 40

The alignment of eye, rear sight, front sight, and bulls-eye; also the relation of the line of sight to the path of the bullet (trajectory)

bullet will continue to fall after passing 100 yards, and will strike below the bull's-eye. This is graphically shown in Fig. 40. A further examination of this figure will show that if we wish to adjust the sights to strike an object 200 yards away instead of only 100 yards, when aim is taken normally as explained, we must either lower the front sight or raise the rear sight. Doing either of these has the effect of causing the barrel to point higher into the air when aim is being taken, and therefore the bullet rises higher into the air, and travelling upward above the line of sight, falls to the line at (say) 200 yards. For mechanical reasons this adjustment for ranges is accomplished on the rear sight by constructing it so that it can be slightly raised or lowered. The simplest forms of iron sights do not permit of any adjustment for range, and hence are correctly adjusted for only one range. With such non-adjustable sights if the object be at only half the range for which the sights are set it will be necessary to aim below the object to hit it, and if the object be beyond this

distance it will be necessary to aim above the object to secure a hit. The rifleman must thus calculate how much the bullet will rise or fall, and must estimate this amount to hold high or low in aiming. This in effect introduces two guesses into the act of aiming with fixed sights at any range other than the one at which the sights are correct, and if in addition we have to estimate the range, another guess is introduced. These two or three guesses lead to considerable inaccuracy. Therefore it is much better practice to have a rear sight that can be raised or lowered for the different ranges, in which case there is at most but one guess, that of the exact range. Military sights have such adjustments, and there is a scale on the rear sight showing how high to place it for 100, 200, 300, 400, 500 yards, etc. If one knows the exact range he can then set his sight accordingly, aim at the bull's-eye, and be sure of hitting it, always of course provided he does his part correctly, and the sights are correct and rifle accurate.

It is also very advantageous to have an arrangement for lateral adjustment on one of the sights. A strong wind from one side or the other may drift the bullet causing it to strike to the right or left of the bull's-eye, and it has been found that much more accurate work can be done by correcting for this with a sight adjustment than by estimating the velocity of the wind, the deviating effect on the bullet, and how much to hold to the right or left for it. This adjustment on a sight is called a *wind gauge*. Sometimes the wind gauge is placed on the rear sight, and sometimes on the front sight.

Rifles are usually placed on the market by the manufacturers equipped with the simplest form of open sights, perhaps with a very crude arrangement for procuring a slight adjustment for elevation. These sights are inexpensive, and are easily understood by the novice. Better sights can be procured to special order, or the common sights can be removed and more efficient sights placed on the arm by the rifleman himself. Usually the sights are so secured to the rifle that this can be done without tools or special knowledge. As one progresses in his skill in shooting he develops decided ideas regarding sights. The manufacturers cannot cater to a thousand ideas, and hence they prefer to equip their rifles with plain open sights which they acknowledge are not suitable for expert use, but which are so cheap that the purchaser practically loses nothing when he equips his rifle with better sights of a type which suits him.

We will now proceed to examine and discuss the various forms of sights commonly seen on American rifles.

FRONT SIGHTS

Front sights may be divided into two kinds—open and globe or covered. The essential points in open sights are strength, stability, shape, visibility, and definition. Sights should be, and almost all of them are, constructed of hard tool steel. They must be securely fastened to the barrel so that they cannot be knocked out of alignment easily. The old method of attachment, still seen on many rifles, was to give them a dovetail base, and drive them into a similar transverse slot in the barrel, driving the sight in always from the right, the sight dovetail being slightly taper to give a secure fit. Generally this method is satisfactory, but occasionally a sight secured in this manner is knocked out of alignment. A much better method of attaching the front sight is to provide a stud on the barrel with a longitudinal slot. The sight, in knife blade form, is fitted into the slot and secured by a pin. This method provides an absolutely stable attachment, although the sight cannot be driven a little to the right or left to align it, as is permitted by the former method, and all adjustment for lateral errors must be made on the rear sight.

The necessity for visibility, particularly in hunting rifles, has led to the invention of an endless variety of front sights. For use in target shooting on a black and white target nothing can compare with a dead black front sight, as this gives a black and white silhouette effect in aiming, and the best definition of sights and target. All military riflemen smoke their sights with burning camphor or in the flame of a kerosene lamp just before starting to shoot in order to obtain a dead black surface on the sights. On objects other than black and white targets, such as big game, a sight is desired that can be seen clearly against the object in any light. For this reason hunting front sights are almost always tipped with German silver, copper, gold alloy, or ivory. The tip may take the form of simply welding a piece of one of these substances to the top and rear face of the sight, or the sight may be "bead" shaped, the face of the bead towards the breech being of one of these substances. Such tips can be seen in poor lights where a dead black sight would be practically invisible, and they stand out plainly against dark colored objects, and the protective coloring of game.

But it is very necessary also that the front sight shall not glimmer or glisten in the sunlight, for this will make it look much larger than it really is, the elevation and windage will differ, fine definition will be lost, and one will not be able to aim with any degree of accuracy. Silver, or German silver is a particular offender in this respect. A dull gold, or dull copper is better, but ivory is best of all. The most popular front sights of today have dull copper, dull gold alloy, or ivory beads. The two former substances have the advantage of being stronger, and they can be blackened with camphor smoke for target shooting without injuring them. The ivory bead is quite a little better for a rifle intended solely for game shooting. I have occasionally read of ivory beads breaking, but I have used them for twenty-five years in hard wilderness hunting, and I have never had one break, or



Fig. 41
Correct and incorrect shape of bead of front sight

ever seen a broken ivory bead. Ivory beads sometimes get yellow from apparent age, and from oil. Wash them off with alcohol, and leave out in the sun for several days to bleach, and they will regain their original dead white color provided they are made of genuine ivory. I believe the question of selection between gold, copper, and ivory is merely one of whether the rifleman intends to do much target shooting with his rifle, or intends to use it solely for hunting. If the latter, choose the ivory bead.

The shape of the tip of the bead is of great importance. If the head be rounded towards the marksman's eye, as in the first cut in Fig. 41, then it is a foregone conclusion that if the sun shines on one side of the front sight (as for example in the early morning when shooting to the north, and strong sunlight shines on the right hand side of the front sight) this side of the tip or bead will be much more brightly illuminated than the opposite side, and the eye in aiming will unconsciously favor the illuminated side, particularly when aim is taken hurriedly as in game shooting. This acts just as though the sight had been moved towards the illuminated side, and the sight will cause one to shoot away from the strong light. With a gold bead

sight rounded towards the eye I have found that my own extreme error from this cause is about 4 inches at 100 yards; that is 4 inches lateral difference in points of impact between strong sunlight shining on the right and left side of this form of sight. All open front sights have this fault to a greater or less degree. Even the straight, flat-top, front sight of the United States magazine rifle, Model 1903, when well blackened with camphor smoke, shows an error due to this cause of about 1 inch per 100 yards. A bead should be of the form shown in the second cut in Fig. 41, to give the minimum error from this cause, the edges of the bead being rounded just enough to take away the sharpness and tendency to chip or nick.

The size of the tip or bead is also of considerable importance. The best general size seems to be $\frac{1}{16}$ inch for gold, copper, or ivory beads. For quick shooting at short range in the brush and dark woods, and for night shooting with a jack light a large bead $\frac{3}{32}$ or $\frac{1}{8}$ inch in



Fig. 42
 Various types of front sights

diameter, known as a "Jack" sight, is undoubtedly an advantage, but it is not so good for long range shooting.

The shape of the sight blade should be such as to give the greatest strength, and to avoid catching in the brush. It is an advantage to have that portion of the steel blade of the sight which is visible from the rear while aiming finely checked, or roughened so that it cannot reflect light. The illustrations in Fig. 42 show the common, and the most popular and best forms of open front sight on the American market.

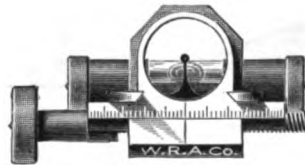
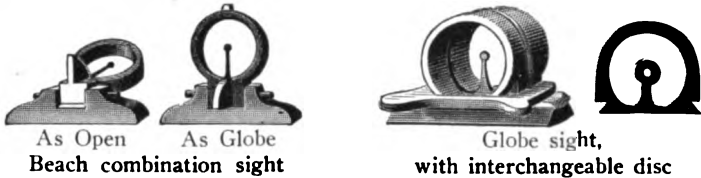

Wind gauge sight,
with spirit level

Fig. 43
Globe front sights

A *globe sight* is one which has a covering of some sort, usually a metal cylinder, covering it to protect it from the glistening sunlight. This form is purely a target sight, and is intended for nothing else. As the sight itself is protected by the cover it is not liable to injury, and it can be made much finer, and give better definition than an open front sight. Often an aperture sight is used under the cover, that is one having a bead which is perforated with a small aperture or peep hole. In aiming the bull's-eye is centered in the aperture. Fig. 43 shows several types of globe sights.

REAR SIGHTS

The great majority of front sights show a similarity of design. There is a blade tipped with some visible metal or ivory, or else it is left untipped. Rear sights, however, are of many varieties. As before mentioned, the simplest form of rear sight is the plain open sight

consisting of a bar having a "V" or "U" shaped notch. Fig. 44 shows one of the oldest forms of rear sights still frequently met with on hunting rifles. It is known as the "Buckhorn" sight because of the similarity of shape when viewed from the breech to a deer's horns. It is not a good sight, and it is remarkable that it should have been so popular. The shape is such that it hides much of the



Fig. 44
Buckhorn rear sight



Fig. 45
Flat top sporting rear sight



Fig. 46
Express rear sights

target in aiming, and it is very difficult to get and keep the aim on running game with it. It is very hard to align the front sight evenly for elevation in the very small "V" notch at the bottom of the crotch. The step for elevating the sight for longer ranges is very crude; the various steps meaning nothing until the rifleman has targeted his rifle with the sight set at each step, and at various ranges. A better shaped sight of the same form is that shown in Fig. 45, known as the Flat Top Sporting Rear Sight. Fig. 46 shows another common form known as the "Express" sight. The stationary sight seen in position for aiming is called the "standard." The "leaves" shown folded down are on hinges and can be raised to give additional elevation.

In recent years almost all manufacturers have given up other shapes of open rear sight for the flat top bar with the "U" notch. This is as it should be. The flat top helps to level the rifle, and cuts off



Fig. 47

Correct method of aligning sights that its top surface shall be on a line with the flat top of the bar, and the "U" gives two sharp right angle corners at its upper extremities to guide the eye in getting the front sight to the correct height, and in the middle of the "U" every time. The correct method of aligning the front sight in such a rear sight is shown in Fig. 47, the line of sight passing through the intersection of the cross lines.

no more of the target from view when aiming than is absolutely necessary. The eye naturally centers the front sight on the flat bar, and thus leads the front sight quickly into the notch. The "U" is the best shape for the notch as the front sight is intended to be aligned so

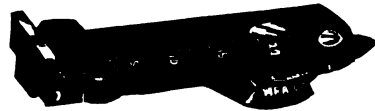
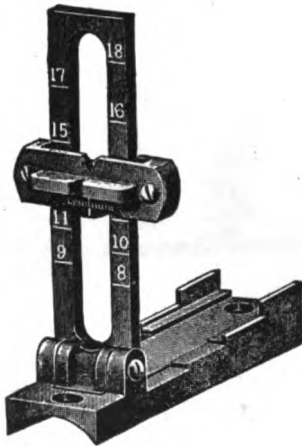

Carbine rear sight

Fig. 48

Military type of rear open sights sometimes seen on sporting rifles

Fig. 48 shows several of the older types of semi-military rear sights where a slight attempt has been made to obtain a better method of elevation. It is supposed that the graduations on these sights are for hundreds of yards of range, but as a matter of fact they are no such thing, as they are far from correct for any modern cartridge that I know of. As with the steps on the sporting rear sight, the value

of these markings will have to be determined by a rather extended course of target shooting by the owner of the rifle. For the longer ranges the leaf is elevated and the slide slid up or down to the desired elevation, and retained at this adjustment by friction alone. This method of retaining the slide in position did fairly well in the days of black powder and light charges, but with modern ammunition it is entirely inadequate, as the slide is liable to, and usually does slip down before the score of ten shots is completed. These sights would be fairly satisfactory today were the standard and slide given a clean cut "U" shaped notch, and a clamp screw provided for retaining the slide in the set position on the leaf.

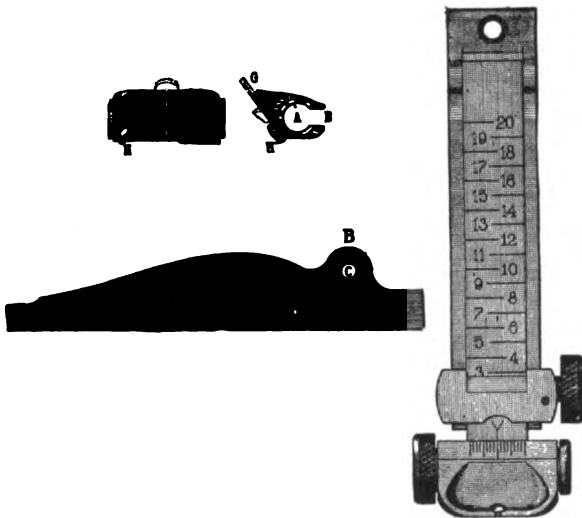

Fig. 49

The best type of open rear sight. The Model 1902 rear sight for the Krag rifle

Fig. 49 shows the very highest development of open rear sight. It is the Model of 1902 rear sight for the United States magazine rifle, Model 1898 (Krag). It is graduated correctly for the .30-40 cartridge for every 100 yards from 100 to 2000 yards, and its construction permits of any elevation between these limits. Elevation is secured by moving the slide up or forward on the leaf. As the slide runs along the upper curved surfaces of the base this elevates the eye piece. The eye piece also has adjustment for windage as shown, which is actuated by the knurl headed screw on the left side, while the screw on the right clamps the elevation adjustment. The eye piece has

attached to it a peep plate which can be pushed into place, thus transforming the sight from open to peep.

Open sights are almost always attached to the barrel a few inches in front of the receiver. If they are placed too near to the breech and eye they will appear badly blurred in aiming. Therefore open sights always have a short sight radius, that is a short distance between front and rear sights. A long sight radius is very desirable as it minimizes errors in aim. A small error made in aligning the sights,



Fig. 50

Showing the advantage of a long sight radius

say of .005 inch, which can hardly be detected by the eye, will cause much less of an error at the target with a long sight radius than with a short one. This is perhaps best graphically described in Fig. 50. A short sight radius, differences in light, dependence on sense of proportion in the individual, and lack of precise arrangements for elevation and windage adjustment are faults common to all open rear sights.

Year by year rifles and ammunition have been gradually improved, but until very recent years aiming devices have remained practically the same — a blade or pointed front sight and an open bar rear sight with a notch in it. The best results cannot be secured from such sights with modern rifles and ammunition. It is a well-known fact that the human eye cannot focus at the same time two or more objects at different distances, even when they are superimposed as are the rear sight notch, the front sight, and the bull's-eye in the act of aiming with open sights. The eye in this case does its best by adopting a compromise focus which shows the three essentials with varying degree of clearness. The requisite skill is difficult of attainment even with the best of young eyes, and the results are greatly influenced by changes of light and other conditions. An open rear sight, in order to be seen at all clearly, has to be placed on the rifle barrel at a considerable distance from the eye when in the shooting position. In many cases the eye may be held when shooting standing at sufficient distance from the sight to obtain a clear outline of it, but when attempting to fire in the prone position the peculiarities of the position make it absolutely necessary to hold the eye much

nearer the rear sight and bad blurring results. On the other hand if the eye be so focused as to make the rear sight appear clear the bull's-eye will be badly out of focus. If the rear sight be placed a sufficient distance forward on the barrel to obtain clear focus in all positions then the sight radius is so shortened as to greatly magnify the results of all errors of aim as already explained.

The optical principles of the peep or aperture sight are quite different. One looks through the aperture. There is no such thing as taking a fine or coarse sight. No attempt need be made to focus on the aperture. It can blur any amount, and the eye can simply center in the middle of the blur without the accuracy suffering in the slightest. This makes it necessary to attempt to focus on but two objects, the front sight and the bull's-eye, and experience has shown that if the eye be focused entirely on the bull's-eye, as it should be, the front sight, being at a considerable distance from the eye, will be seen with very good definition. The rear aperture sight, can, and should be, placed near the eye, as near as possible without endangering the eye from recoil, and this greatly increases the sight radius, and thereby considerably minimizes the errors which result from small imperfections in alignment. Added to these facts, the eye has a natural aptitude for centering objects. It can center a front sight or a bull's-eye much more accurately in an aperture than it can get it in the center of a notch, and at the same time at a uniform height in the notch. Moreover, differences in light do not affect its accuracy in making this alignment. Many arguments could be quoted to prove the superiority of aperture sights over open sights. For years match rifle shots have used nothing else. The best scores with all rifles have been made with aperture sights. All the world records have been made with either aperture or telescope sights. Nine times out of ten when a sportsman has once given that form of aperture sights best adapted to hunting a thorough trial he will thereafter use nothing else.

Many men gain a false impression of the peep sight because the only one with which they are familiar is one of the forms which are placed on the barrel far away from the eye. This is not the right position for an aperture, and no conception of the possibilities of the aperture can be gained from the examination or use of a sight so placed. The aperture must be near the eye, either above the small of the stock, or certainly not further forward than the rear of the receiver. Again, many complain that they find difficulty in exactly

centering the front sight in the aperture, not realizing that if they pay no attention whatever to trying to center the front sight the eye will do it naturally and do it far more accurately than they can do it by taking great pains over it. *The eye should simply look through the peep.* The small size (say .05-inch average diameter) of an aperture, and the ease with which the true center is found by the eye, implies a considerable reduction of error compared with open sights. Although the diameter of the hole is .05 inch, the edges are blurred when aiming because the aperture is so near the eye and consequently out of focus. As a consequence the utmost distance the eye can stray

from the exact center is about half of half, .05 inch — roughly .01 inch. The natural aptitude of the eye in centering objects still further reduces this error. An error of .01 inch can easily be made with open sights without the rifleman being at all cognizant of it.

We can roughly divide aperture or peep sights into two general groups: The disk aperture and the Lyman peep. In the former group the aperture is placed in a plate, usually a circular plate, called a disk. This disk shuts off all view of the target except that portion which can be seen through the peep hole. This peep hole is small, from .03 inch to .06 inch. Figure 51 shows a sample of this group of sights, and Fig. 39 shows how they appear when aiming at a bull's-eye target. This is the best form of peep for target shooting. The disk shuts off the extraneous rays of light and permits one to see the bull's-eye with a greater degree of clearness, particularly when the source of light comes from the front and shines in the shooter's eyes.



Fig. 51
Vernier peep sight for target rifle

In addition there is what is called an "orthoptic" effect, the small aperture and the disk causing everything seen through it to appear in perfect focus. Thus the bull's-eye and

front sight appear perfectly sharp, and small errors in the individual's vision are corrected. This group of sights is entirely for target shooting. They cannot be used successfully for warfare or for hunting, because they give so little view of the target and landscape around the target that they are of absolutely no use against moving targets. They cannot be used in poor lights. It is hard to catch the target and aim quickly with them.

The second group — the Lyman peep sights — may be said to represent the most modern and all around efficient form of metallic

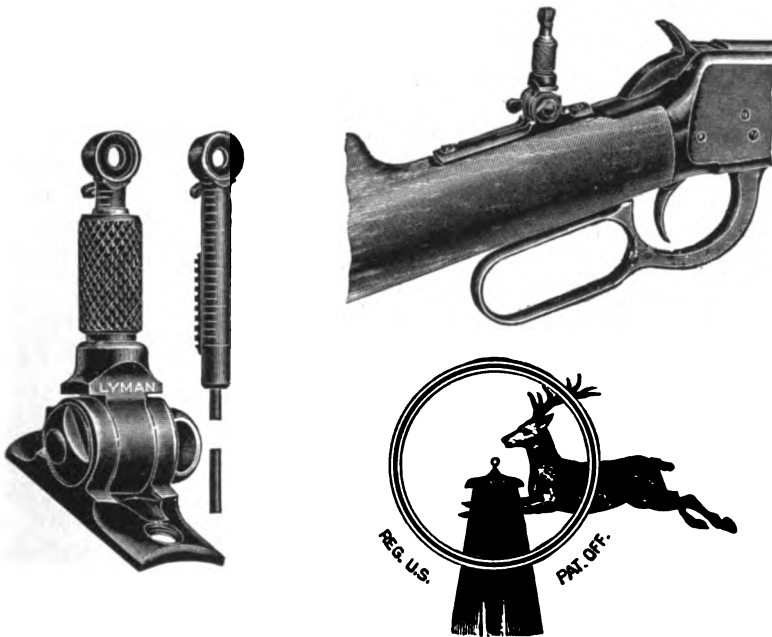

Fig. 52

The original Lyman peep sight, and the way it appears when aiming at running game

sights. The principle was first embodied in the invention of Mr. William Lyman of Middlefield, Connecticut, about thirty years ago, but it has only been within recent years that the system has attained its deserved popularity. The Lyman system consists of placing the aperture in a very small disk so that in effect it is nothing more than a ring. This sight is near to the eye, and in aiming it appears like a blurred ring. The ring is so thin that it does not obscure a complete vision of the target and all the landscape around the target. In

aiming the eye looks through the blurred ring, the centering ability of the eye causing the accurate alignment. The effect is to reduce the act of aiming to practically that used with the shotgun, namely placing the front sight on the object and pulling the trigger. It is just as though there were but one sight on the rifle. The rear sight causes no obstruction to the vision, there is no painstaking effort necessary to align the two sights, and it is not necessary to adopt a compromise focus of the eye. Fig. 52 shows the original Lyman sight and the method of aiming it.

Some of the advantages of the Lyman system are: One sees the whole target and landscape around the target in aiming. In actual practice no attention need be paid to the rear sight in aiming, thus greatly simplifying aiming and greatly quickening it. Such a sight can be seen in very poor lights when open sights could not be used at all. The sight does not darken the target. It is very quick to catch and to use on running game. Aim is as accurate with it as with any other iron sights except the disk system of peep sight where the orthoptic effect allows better definition. The sight is not affected by light as all open rear sights are.

Personally I have used Lyman sights on all my hunting rifles since 1893, and I would not think of using any other system on a hunting rifle except a telescope sight for special uses. I also believe the Lyman system to be the very best for a military rifle, and in this I am borne out by the action of the British War Office in adopting for the Enfield rifle the Lyman system of sighting, and, moreover, thinking so much of it that they made this change during the Great War.

It was Mr. Lyman's idea, and this is correct, that the sight should be as near the eye as possible; that is just far enough away that the sight would not strike the eye when the rifle recoiled. The first Lyman sights were all made to be placed on the tang of the rifle. The introduction of heavier and longer cartridges, and the consequent necessarily greater distance that the bolt had to travel to the rear in order to load these long cartridges, made it impossible to use tang sights on many modern heavy rifles. The bolt would strike the tang sight and turn it down. This led to the designing of what is known as the Lyman receiver sight, the sight being secured to the rear of the receiver. This method of attachment answers very well indeed in most cases, yet it is a fact that the Lyman sight mounted in this way cannot be caught as quickly, nor seen in as poor lights as the same sight mounted on the tang so as to come nearer to the eye. On one

hunting trip in Montana there were four of us in the party. Two had their rifles equipped with Lyman receiver sights, and two with Lyman tang sights. We tried these sights out in competition under all conceivable conditions, and all of us came to the conclusion that aim could be caught much more quickly with the tang sight than with the receiver sight, and also that the tang sight could be seen clearly enough to aim accurately with at least fifteen minutes earlier in the

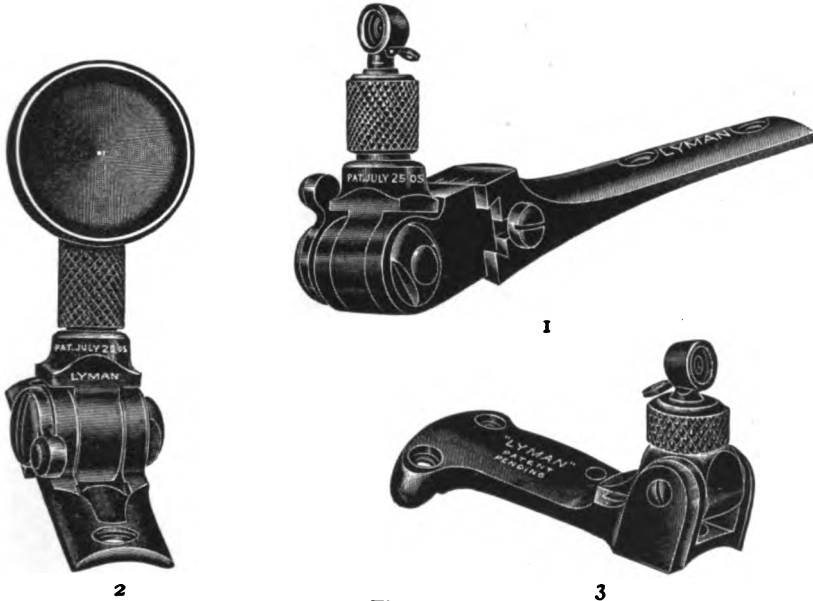
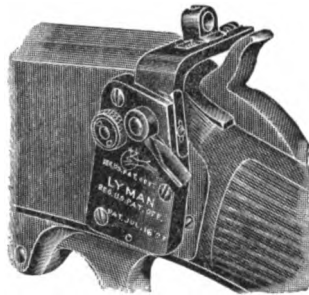
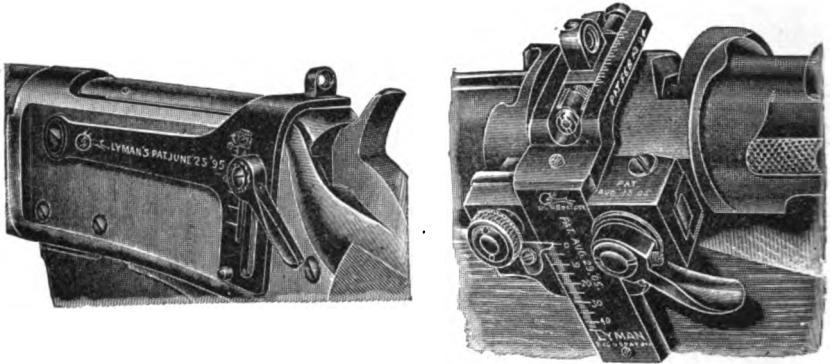

Fig. 53

Various forms of Lyman peep sights

- 1 — No. 20½ rear sight with wind gauge for Savage Model 1899 rifles.
- 2 — No. 1 rear sight for Remington-U. M. C. No. 14 rifle.
- 3 — No. 2A rear sight with detachable cup disc for target shooting.

morning and fifteen minutes later at evening than could the receiver sight. These are important considerations to the hunter and the soldier. Nevertheless the receiver sight on the Lyman principle is a very satisfactory sight. It is better for a military sight than the tang sight because the latter is really too near the eye to be used in the prone position without assuming a very cramped attitude. It is also stronger and less liable to injury than the tang sight. Figure 54 shows a number of Lyman receiver sights adapted to rifles which have long bolts, which, withdrawing a considerable distance to the



Marlin

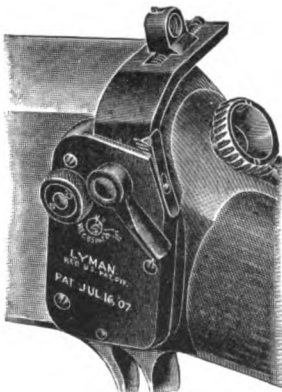

Winchester

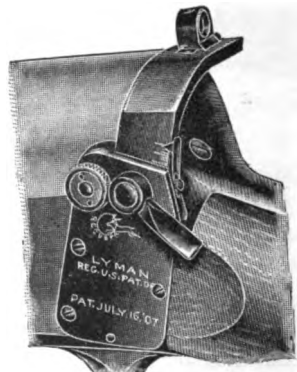

Remington

Fig. 54

Various types of Lyman receiver sights

rear in the act of loading, make the use of the ordinary Lyman tang sight impossible.

In recent years the Marble Arms and Manufacturing Company have

placed on the market a tang sight constructed on the Lyman principle which has a flexible base. There is a spring in the joint, and when the sight is folded down forward or backward it will, when released, immediately spring up again into the firing position. This sight can be used on a number of lever-action rifles which have bolts too long to permit of attaching the ordinary Lyman tang sight. As the bolt

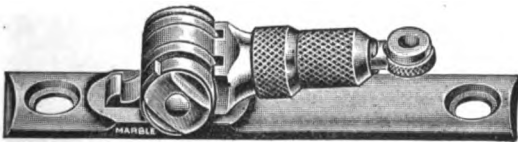
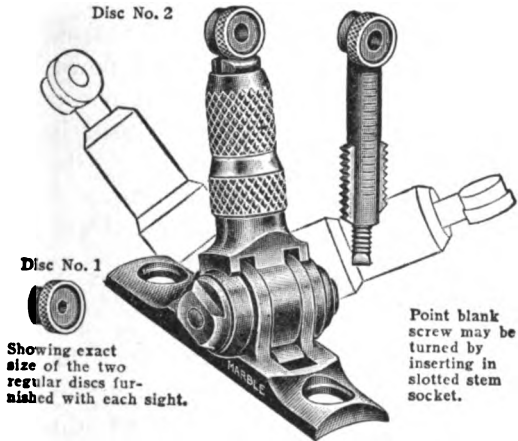

"Flexible" sight, showing sliding lock button

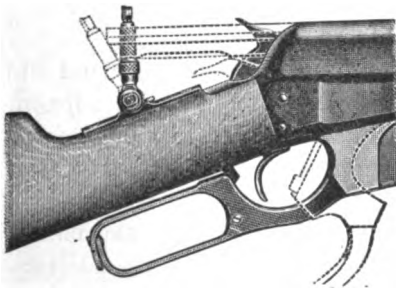

Regular base flexible sight on rifle with long firing bolt

Fig. 55

The Marble flexible base rear sight. Same principle as the Lyman. A strong spring holds it in the firing position, and if struck by anything it bends down and springs back into position. It can be bent down against the tang and held there by a lock when the rifle is placed in a case.

comes to the rear it pushes down the Marble sight, and when the lever is closed and the bolt moves forward, the sight at once springs up into the firing position. This is a very satisfactory sight on the Winchester Model 1895 rifle, except on the .405 caliber, the recoil in this caliber being a little heavy for any tang sight, as the sight is liable to strike the eye during the recoil. Fig. 55 shows this sight.

The older models of the Lyman sight had but one adjustment, a screwing up and down of the stem for elevation. The stem has graduations on it, and it is screwed up and down by rotating the knurled sleeve. This is fairly satisfactory as one can get quite fine adjustment by taking care to revolve the sleeve just a little. But it is not positive. There is no way of recording the *exact* elevation. On most of these sights moving the rear sight up or down one graduation caused a change in point of impact of about 5 inches at 100 yards. The first form of receiver sights were even more crude. There were a number of marks on the side of the sight and a pointer. A clamp secured the sight in position. One loosened the clamp and slid the sight up or down to the desired mark. The pointer snapped in the notch forming the mark, and if this mark was a little out of the correct adjustment it was impossible to adjust as desired as the sight would always slide a little up or down so that the pointer went into the middle of the notch. This form of sight was later improved by constructing it with a first-class scale for elevation and a knurl-headed screw with which to move the sight up and down for obtaining fine adjustment. At the same time the need for lateral adjustment was recognized by adding a wind gauge to many models of Lyman receiver sights, but it has not been until very recently that tang sights were similarly equipped.

Within the last five years the insistent demand on the part of expert rifle-men for sights with absolutely positive adjustment, and with adjustments which could be translated into minutes of angle, has led to the placing on the market of two most perfect aperture rear sights of the Lyman form. One of these is a receiver sight, the Lyman No. 48. It is adapted to the United States magazine rifle, Model 1903, but by a little filing of the base can be satisfactorily mounted on almost all other repeating rifles. Its adjustment for elevation reads to minutes of angle. It also has a wind gauge which has "points" of the same value as the points on the wind-gauge scale of the regular military sight on this Model 1903 rifle, so that the windage tables calculated for this rifle can be used with this sight as well as with the

regular military sight. That is to say, the points on the scale of the wind gauge have a value of 4 inches at 100 yards. One revolution of the wind-gauge screw moves the wind gauge one point. A click arrangement is placed in this screw, so that it clicks for every quarter

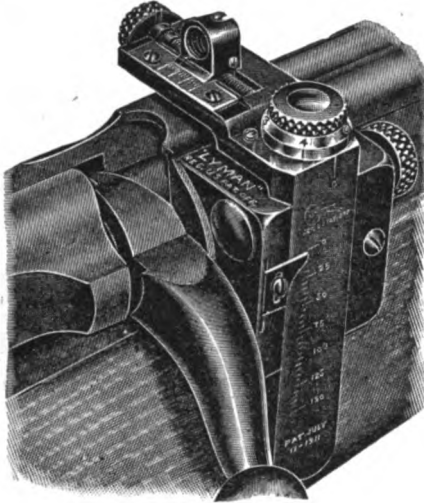

Fig. 56
Lyman No. 48 receiver sight for Springfield rifle

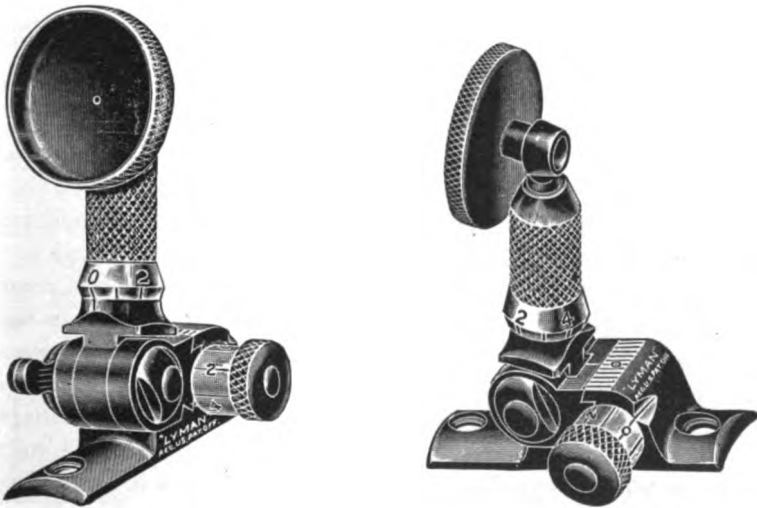

Fig. 57
Lyman No. 103 rear sight. The most perfect rear sight ever made

revolution or quarter point. A quarter point is worth just one minute of angle, so that we really have an adjustment to minutes of angle for both elevation and windage. The elevation screw is also arranged to click for every minute of adjustment. These clicks can easily be felt but are not audible, so they are not liable to disturb game or give one away to the enemy. They are a great advantage, in that the adjustments never slip up or down unintentionally, and it is very easy to make positive adjustments at night by feel alone. This is a most satisfactory sight for either military, long-range target, or hunting use.

The second sight is the Lyman No. 103 tang sight. It also has adjustments for both elevation and windage, but in the case of this



Fig. 58

Lyman rear sight on the author's sporting Springfield rifle. When the rifle is cocked the sight is brought back near the eye, but the act of firing carries the sight forward so that there is no danger of its striking the eye during the recoil. This is a much better sight for hunting than the receiver sight as it can be seen in poorer lights, and aim can be caught much quicker with it than with the receiver sight.

sight these adjustments read to half minutes of angle. The sight was constructed in this manner to satisfy the demand of the gallery shooters, particularly those competing in the series of gallery competitions instituted by the National Rifle Association. Here the demand is for a sight which will adjust to just $\frac{1}{8}$ inch at 25 yards, and a half minute of angle just does this. This also is a most satisfactory rear sight. It is extremely well constructed of excellent material, arrangement is made to take up all back lash and lost motion, and the adjustments have the click arrangement for half-minute adjustment. It is adapted to the Winchester and Stevens Ideal single shot rifles, and to the Winchester Model 1894 rifle. With a little alteration it can be made to answer for the Winchester Models 1886 and 1892 rifles. For the models to which adapted it is a better hunting sight than the No. 48

receiver sight, of course mainly because the aperture comes nearer to the eye.

The diameter of the normal aperture in Lyman sights is about $\frac{3}{32}$ inch, and there is usually an additional plate attached to the stem which is secured by a hinge and can be folded up into the normal aperture and contains a peep hole about $\frac{1}{32}$ inch in diameter. I have never found any use for this small peep, and to prevent it some time getting half-way up and down and thus making it impossible to use the sight without folding it down, I have always removed it from all Lyman sights on my rifles. On special order, Lyman and the Marble models of the Lyman sights can be provided with an attachable cup disk having an aperture about .05 inch in diameter. It is a decided advantage to have this attachment as it makes the sight much better for purely target shooting, and it can always be taken off for field work. One can use it for testing ammunition and for sighting in the rifle, as the elevations and zeros found with it will be exactly the same when it is removed and the true Lyman aperture used.

With all rear sights, both open and peep, it is very desirable that the edges towards the eye be clean cut and sharp, so that there can be no reflection of light or glimmer from them. They should be bevelled on the side farthest from the eye, so as to present a knife edge at right angles to the eye and an absolutely perpendicular surface towards the eye. This is often neglected even by the best makers. If there is trouble with the edges glimmering, a jeweler or expert gunsmith can always remedy the trouble in a few minutes by sharpening the edges. The sights should be always kept well blued to a dead black so as not to reflect light. If they become bright through wear, it is well to send them back to the maker occasionally for rebluing. Sights are delicate instruments. To be suitable for aiming a modern accurate rifle they must be in perfect condition. They must be carefully cared for and guarded from all blows and injury. Next to the bore of the rifle, the sights are the most important parts of the weapon.

CHAPTER VIII

SIGHT ADJUSTMENT

THE sights of a rifle are very seldom correctly adjusted when the owner purchases the same. Some factories make no pretext whatever of adjusting their sights. Others adjust them with considerable care, but often at a range other than that to which the rifleman desires them adjusted. Thus the Winchester Repeating Arms Company adjust all the sights on their high-power rifles, and on many of their black-powder arms as well, on the 200-yard target. That is, when the rear sight is at its lowest elevation the rifle is correctly sighted to hit the center of an 8-inch bull's-eye at 200 yards when aimed at its lower edge. This is entirely too high a sighting for most men, especially for hunting. Take a .30-30 rifle, for example. When fired at 200 yards, its trajectory above the line of sight at 100 yards is 5.79 inches. If this rifle is sighted for 200 yards it will then shoot 5.79 inches, plus 2 inches difference between point of impact and point of aim on account of being sighted to hit 4 inches high at 200 yards, or 7.79 inches above where the top of the front sight is held at 100 yards. This is enough to go clear over the top of a deer on a perfect body hold at 100 yards.

Moreover, experience has shown that a sight adjustment that is correct for one man will seldom be correct for another, owing to little differences in methods of aim, eyesight, manner of holding the rifle, etc. Therefore the chances are that a new rifle, besides shooting very high, will not be correctly adjusted for its owner, and the first thing to do is to adjust the sights.

We must first consider the shortest distance at which we wish to fire, and adjust our sights for that distance. Let us say 50 yards, because with sights adjusted for this range we are always ready for very close shots which sometimes present themselves, such as the head of a grouse at 15 yards. Select therefore a safe range of 50 yards on which to fire, and if possible have at hand a table, a chair, a small box about 10 inches high, a blanket, a small piece of brass rod several inches long, a couple of files — one a small saw file and the other

a very small, rat-tail jeweler's file — a number of targets about a foot square with a black bull's-eye about 3 inches in diameter on the same, and rifle and ammunition. Sit down in rear of the table, placing thereon the small box with the blanket thickly folded on top. Arrange table, chair, box, and rifle so that when sitting in the chair one will have his shoulders and chest in about the same upright position relative to rifle and target as when firing offhand. The rifle is to be rested on top of the blanket on the box, so that the forearm of the rifle rests on the thick, soft blanket about 8 inches ahead of the breech. Experiment with the position until it is comfortable, and the rifle, shoulders, and head are approximately in the same positions as when firing offhand. (See Figs. 155 and 156.)

Now with the sights on the rifle set as low as they will go, fire a single shot at the target, using great care as to aim and trigger pull. Note where this shot strikes. (A pair of field glasses are convenient, as the bullet hole can then be seen without having to get up and go to the target after every shot.) Now adjust the sights according to the following rule: "*Move the rear sight the way you wish your shot to go, or the front sight in the opposite direction.*" That is, if your shot has gone high, striking above the bull's-eye, you must either lower the rear sight, or, if this is impossible, you must file it down on top, deepening the notch with the little rat-tail file.

If the shot has gone low, you can either raise the rear sight, or you can file down the front sight. If the shot has gone to the right and it is desired to make the rifle shoot more to the left, then the rear sight must be moved to the left. If it is fitted into a slot in the barrel, strike the sight a smart blow on the dovetail base, resting the short brass rod against the base and striking the rod with the hammer. If it becomes necessary to move the rear sight so far to the left as to make it unsightly, then the front sight can be moved a little to the right and it will not be necessary to set the rear sight over so far. It is best to verify the shooting by firing three or four shots before starting to adjust the sights. Go slow in moving them, remembering that a very slight move of the sight will change the point of impact considerably on the target. When you think you have moved the sight far enough, shoot again for verification. This is the rough and usual method of adjusting the factory sights on a new rifle. It is not very satisfactory. In fact it is not at all satisfactory for a trained rifle shot. Only the novice or the very poor shot will put up with such methods at all.

Decidedly the best sights are those having accurate adjustments for both elevation and windage, and it is a real pleasure to adjust such sights on a rifle, besides a great saving in ammunition. Often the saving in ammunition will pay for the sights, because with the ordinary factory sights and the crude methods of knocking the sights back and forth and filing down one can easily fire 30 or 40 rounds before he feels that his sights are correctly adjusted for him. With modern adjustable sights, however, the trained rifleman needs but three or four rounds to adjust the sights, after which he not only has them adjusted for one range, but he also knows the correct elevation for all other ranges. It is only necessary to place these sights on the rifle and go to the range where the same equipment should be at hand, except that the small brass rod, the hammer, and the files will not be necessary. Sit down in the same manner and carefully fire a shot, notice where it has struck, and then fire another for verification. If these shots have both struck close together then measure the vertical and horizontal distance in inches from them to the center of the bull's-eye. This will give you how much your shots are striking from the point of aim. All that is then necessary is to follow the rule for determining how much a certain change in sight adjustment will move the point of impact on the target as given below, and adjust the sight according to that rule and the table accompanying it, and the rifle is sighted in. Of course it is only correctly sighted for the individual who did the shooting and for the particular ammunition that was used at the time.

RULE FOR DETERMINING HOW MUCH A CERTAIN CHANGE IN
SIGHT ADJUSTMENT WILL MOVE THE POINT OF
IMPACT ON THE TARGET

First: Measure the distance from the front to the rear sight, and divide this into 3600.

Second: Measure the dimension of the graduation or move that you are trying to find the value of on the sight. The accompanying table gives the dimensions of the smallest graduations on some of our most popular and useful rifle sights.

Third: Multiply the first result by the second result, and the final result will be the distance that the point of impact will be moved at 100 yards. For 200 yards double this, for 300 yards multiply it by 3, for 500 yards multiply by 5, for 50 yards divide by 2, and so on.

Example: We have a Winchester Model 1894 rifle equipped with a No. 1 Lyman rear sight. We wish to determine how much an increase or decrease of one graduation on the elevation stem will move the point of impact at 100 yards. First, the distance between the front and rear sights is 30 inches. Thirty-six hundred divided by 30 equals 120. Second, from the table the dimension of one graduation on the stem of this sight is .05-inch. Third, 120 multiplied by .05 equals 6 inches. That is, if we are shooting with an elevation of 2 points at 100 yards, and we then change our elevation to 3 points we will raise our point of impact 6 inches on the target.

Sometimes, if we know the trajectory of a cartridge, we can determine the correct sight setting for various ranges without firing at those ranges. Suppose the rifle in the above example is a .30-30 Winchester. From the table of trajectories in the Winchester catalogue we find that the height of the trajectory at 100 yards when shooting at 200 yards is 5.79 inches — practically 6 inches. In targeting the rifle at 100 yards we find that the correct elevation for that range with the Lyman No. 1 rear sight is 2 points or graduations on the sight stem. Now, from the above calculation it is evident that if we raise the rear sight to 3 points the rifle will shoot 6 inches higher at 100 yards — that is, it will have just the height of the 200-yard trajectory at 100 yards — in other words, it will be correctly sighted for 200 yards.

DIMENSIONS OF THE SMALLEST GRADUATIONS OF RIFLE SIGHTS

Make and model of sight	Elevation graduation, inches	Windage graduation, inches
Lyman, rear sight, Nos. 1, 1A, 2, and 2A05
Lyman, rear sight, Nos. 29½ and 30½05	.02
Lyman, rear sight, No. 3502	.025
Lyman, rear sight, No. 3602
Lyman, rear sight, Nos. 41 and 4202	.02
Lyman, rear sight, No. 4502
Lyman, rear sight, Nos. 47 and 5205	.02
Lyman, rear sight, No. 48 ¹008	.032
Lyman, rear sight, No. 103 ² and No. 10100417	.00417
Lyman, front sight, Nos. 7, 8, and 1802975

¹ The dimensions given are for 1 minute (i.e., ½ revolution of elevation screw) of elevation, and ¼ point of windage (i.e., ¼ revolution, or 1 "click" of windage screw). One minute in elevation, or ¼ point in windage adjustment, gives a change of point of impact of 1 inch at 100 yards with this sight on the Model 1903 rifle.

² Each complete revolution of elevation and windage screws are graduated into 10 parts, or "clicks," which gives a change for each click of ½¹⁰-inch, which, with a 30-inch sight base equals ½ minute of angle, or ½ inch at 100 yards, ¼ inch at 50 yards, and ¼ inch at 25 yards, or 1 inch at 200 yards. The No. 101 rear sight has the same elevation adjustment, but no windage.

Make and model of sight	Elevation graduation, inches	Windage graduation, inches
Lyman, rear sights, Nos. 21 and 38:		
From 1st to 2nd graduation	.05
From 2nd to 3rd graduation	.05
From 3rd to 4th graduation	.05
From 4th to 5th graduation	.058
From 5th to 6th graduation	.079
From 6th to 7th graduation	.105
From 7th to 8th graduation	.130
From 8th to 9th graduation	.145
Lyman rear sight No. 33:		
From 1st to 2nd graduation	.05
From 2nd to 3rd graduation	.05
From 3rd to 4th graduation	.05
From 4th to 5th graduation	.055
From 5th to 6th graduation	.065
From 6th to 7th graduation	.073
From 7th to 8th graduation	.100
From 8th to 9th graduation	.130
Marble flexible base rear	.0417

TABLES OF SIGHT CORRECTIONS — UNITED STATES ARMY RIFLES
ELEVATION CORRECTION TABLE

Corrections corresponding to a change in elevation of 100 yards.

Range (yards)	Model 1898 Rifle	Models 1903 & 1917 Rifles
	Correction corresponding to a change in elevation of 100 yards (inches)	Correction corresponding to a change in elevation of 100 yards (inches)
100	4.87	2.88
200	11.38	5.44
300	19.95	10.08
400	31.48	17.28
500	46.04	24.72
600	63.86	34.16
700	86.00	46.68
800	108.87	62.48
900	136.02	79.08
1,000	166.08	99.24

WINDAGE CORRECTION TABLE

Correction corresponding to one point on the wind-gauge scale.

Range (yards)	Model 1898 Rifle	Model 1903 Rifle
	Correction caused by moving the movable base one point (inches)	Correction caused by moving the movable base one point (inches)
100	6	4
200	12	8
300	18	12
400	24	16
500	30	20
600	36	24
700	42	28
800	48	32
900	54	36
1,000	60	40

NOTE: The rear sight on the Model 1917 Rifle has no wind-gauge.

MINUTES OF ANGLE AND ANGLES OF ELEVATION

A circle is divided into 360 degrees. Each of these degrees is further divided into 60 minutes. An angle of 1 minute is an angle whose arc is $\frac{1}{21,600}$ part of the circumference of a circle. With a circle having a radius of 100 yards this arc of a 1" angle will measure 1.0472 inches from end to end in a straight line. That is to say, 1 minute of angle subtends 1.0472 inches at 100 yards. It is very necessary to understand this before proceeding further.

For convenience' sake, and simplicity, we consider that 1 minute of angle subtends 1 inch at 100 yards. It will therefore subtend 2 inches at 200 yards, 3 inches at 300 yards, and so on.

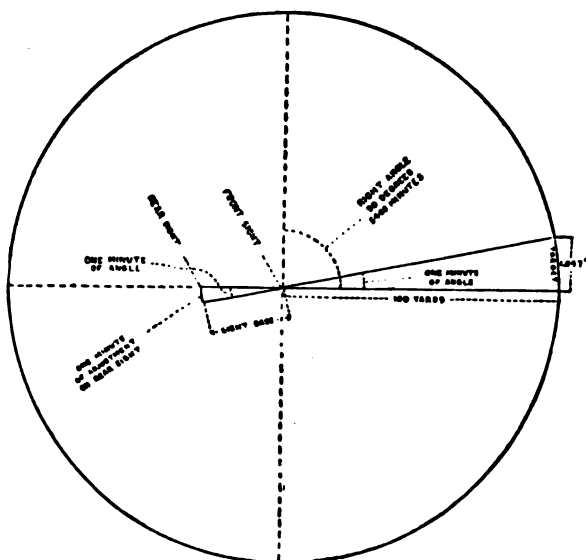

Fig. 59

Illustrating a minute of angle

Suppose we have a rifle whose front and rear sights are 30 inches apart. This distance between the sights is called the sight radius. In 100 yards there are 3600 inches. Thirty-six hundred inches divided by 30 inches equals 120. The sight radius is therefore $\frac{1}{120}$ of the range. If we move our sight up or down one inch in elevation, we will raise or lower the point where our shots are striking on the target 120 times this much, or 120 inches. Now suppose on our rear sight we have graduations measuring .008 inch. That is, the graduation lines on the

elevation scale are .008 inch apart. If we move our rear sight up one of these graduations, we will have raised our point of impact 120 times .008 inch on the 100-yard target. Now 120 multiplied by .008 equals .96 inch,—practically, to all intents and purposes, 1 inch. Thus one graduation on this sight (.008) gives us an adjustment or movement of practically 1 minute of angle.

It is necessary to comprehend this in order to understand and appreciate the many experiments and explanations which follow in this work.

Minutes of angle are used by all ballistic experts and by the Ordnance Departments of all armies in describing and comparing elevations and sight readings. It is the unit of measure in discussing the sighting of a rifle, in just the same way as the foot and inch is the unit of measure of the carpenter. An adjustment on the sight of 1 minute of angle moves the point of impact 1 inch at 100 yards. That is all there is to it.

For example, let us turn to the data of our own Ordnance Department, and look at the angles of elevation with our service rifle, the United States rifle, Model 1903 (New Springfield), using the .30-caliber, Model 1906 ammunition. This ammunition has a 150-grain, sharp-pointed bullet, and when fired it leaves the muzzle of the rifle with an initial velocity of 2700 feet per second. The angles of elevation required to make the bullet hit the point of aim at the various ranges are as follows:

Muzzle	Zero	600 yards	20.68 minutes
100 yards	2.40 minutes	700 yards	26.15 minutes
200 yards	5.18 minutes	800 yards	32.50 minutes
300 yards	8.26 minutes	900 yards	39.86 minutes
400 yards	11.83 minutes	1,000 yards	48.30 minutes
500 yards	15.90 minutes		

The rear sight on this rifle has graduations on it for every 100 yards, from 100 yards to 2800 yards, but the expert military shot will have nothing to do with them. These yard graduations, while they are just the thing for shooting in war, are not at all fine enough for expert military target shooting, so the expert uses a little instrument called the micrometer sight adjuster with which he adjusts his sight. Then instead of recording the adjustment for a certain range as so many yards, he records it as so many minutes, taking the reading from the micrometer. The micrometer reads to minutes of angle. This instrument is very convenient. Suppose the expert is shooting at 600 yards. At that range 1 minute of angle subtends 6 inches (remember 1 inch

per 100 yards). If his shots are hitting 1 foot below the center of the bull's-eye all he has to do is to snap the micrometer sight adjuster on the sight, raise the elevation 2 minutes, and his rifle then shoots correctly into the center of the bull's-eye. Also he has a little table of the elevation required at the various ranges at which he shoots, which reads as follows:

From 200 to	300 yards raise	3. minutes
From 300 to	350 yards raise	1.7 minutes
From 350 to	400 yards raise	2. minutes
From 400 to	500 yards raise	4. minutes
From 500 to	600 yards raise	4.8 minutes
From 600 to	800 yards raise	12. minutes
From 800 to	900 yards raise	7. minutes
From 900 to	1,000 yards raise	8. minutes

A comparison of this table with that of the angles of elevation of the service rifle just given above will show that the two are practically the same. Suppose the rifleman decides to change from one make of ammunition to another. From some brother rifleman he obtains the data for it. This new make requires 2 minutes less elevation than the old make, and at once he knows just where to set his sight for every range. Suppose he is firing a new rifle at 600 yards, and it is shooting well into the center of the bull's-eye, and he then wants to go to the 800-yard range at which he has never fired this rifle. He merely snaps on the micrometer sight adjuster, runs his sight up 12 minutes, and his first shot at 800 yards, if he does his part correctly, will be in a horizontal line passing very nearly through the center of the bull's-eye.

A rear sight reading to minutes of angle is of immeasurable value to any rifleman. A perusal of the pages of this work will convince the reader that if he is to know his rifle thoroughly, and to become really expert with it, at long range as well as short, he must come to a sight reading to minutes of angle. The only sights on the American market now which have this convenient reading are the following:

The Lyman No. 48 rear sight, the elevation scale of which reads to minutes of angle; and the wind gauge of which reads to 4 minutes of angle, but has an operating screw which clicks for every minute. This sight is made for the United States magazine rifle, Model 1903 (New Springfield), going on the receiver thereof, but a first-rate mechanic can easily make slight changes in its base and place it on almost any of our rifles.

The Lyman No. 103 rear tang sight, which reads to half minutes of

angle for the convenience of the gallery shot who wishes a sight which he can adjust to $\frac{1}{8}$ inch at 25 yards ($\frac{1}{2}$ minute). This is adapted to the Winchester and Stevens single shot rifles, and to the Winchester Model 1894 rifle, but with slight alteration can be fitted satisfactorily on almost any of our rifles which will allow of mounting the old Lyman No. 1 rear tang sight.

The Winchester telescope sight, which when used with a No. 2 rear mounting, the front and rear mountings being placed on the barrel 7.2 inches apart, has a reading for both elevation and windage of a half minute of angle.

CHAPTER IX
TELESCOPE SIGHTS
INTRODUCTION

A TELESCOPE sight is a small telescope having cross wires similar to a surveyor's transit, and is mounted on the barrel of the rifle in such a manner that in aiming in the usual manner one's eye looks through the telescope at the object. The object is magnified by the telescope, and it is only necessary for the riflemen so to move the rifle that the cross-hairs are superimposed on the particular place that he wishes his shot to strike. The tube of the telescope is made of steel. Two methods of adjustment are in vogue. The commonest is to elevate and deflect the tube by an adjustable rear mounting in exactly the same manner that the rear sight is ordinarily adjusted. The method of elevating and deflecting must allow for very close adjustment, as the front and rear mountings of the telescope are so much closer together than are ordinary front and rear sights. The other method is to depress the cross-hairs by means of a screw and dial, which in effect causes one to aim higher. As a rule the first method is preferable as being more positive and accurate.

The chief advantages claimed for the telescope sight are :

(a) It greatly reduces the errors of aim. The error of aim with the best iron sights used by marksmen with perfect vision is 1 inch per 100 yards — that is, for example, 5 inches at 500 yards. The eye cannot see to aim closer than this at the various ranges. With the telescope sight this error is divided by the magnifying power. For example, with a telescope sight magnifying 5 diameters, the error of aim at 500 yards would be only about 1 inch, depending slightly upon the fineness of the cross-hairs, and whether any mirage was present in the air.

(b) It allows objects to be seen more distinctly than with the naked eye. Also it permits the vision to penetrate into places where it could not otherwise, as, for instance, into the edge of a woods, and into dark places that appear perfectly black when viewed with the naked eye.

(c) Low power telescopes with large bright fields permit aim being

taken in lights when the iron sights cannot be seen at all. With a good 3-power telescope sight one can see to aim accurately on moonlight nights.

(d) Various forms of telescope sights have certain other advantages which will be discussed later, together with the disadvantages.

A good telescope sight is quite expensive, and it is to a certain extent a delicate instrument. The whole object of equipping a rifle with one is to attain better accuracy than can be had with iron sights. The telescope sight will be here considered primarily as an instrument with which we wish to attain a greater accuracy of aim by (a) eliminating the errors of aim, and (b) making the object aimed at more distinct.

Anything which does not reduce, or actually increases, the error of aim is entirely out of place in connection with a telescope sight. For example, a set of mountings which will not adjust, or are capable of being read closer than, say, 3 inches at 100 yards, is entirely out of place because it introduces an error of as much as 3 inches at times, and this is three times larger than the error of the unaided eye, and fifteen times larger than the error of a good, 5-power, telescope sight.

It will be made evident in the course of this chapter that no telescope sight has ever been produced that is entirely satisfactory for either military use or for big game shooting. Our telescope sights have all been constructed with a view to target shooting, and foreign telescope sights with a view to sale only, and not for use under service conditions. The purpose of this chapter will, therefore, be not so much to describe existing American models, as to discuss the design, capabilities, and development of telescope sights suitable alike for target shooting, war, and sport.

For the sake of brevity the telescope sight adapted to the aiming of rifles will here be referred to as a "scope," a term in common use among American riflemen.

POWER AND FIELD

The power of a scope is its ability to magnify objects seen through it. A 5-power scope magnifies objects five times or diameters, or makes the object appear five times nearer than it actually is. To determine the power of a scope, look through it at a brick wall or similar object. Keep the other eye open, and so move the scope that the image seen through it is alongside the image seen by the naked eye. Count the number of bricks seen by the naked eye which line up against

one brick seen through the scope. The result will be the magnifying power.

The field of a scope is the area embraced by the object seen through it when the eye is at the correct distance from the eye-piece. It is usually designated by the diameter at a certain range. To determine the diameter of the field, choose a level piece of ground. Drive a stake A at 100 yards from the scope. Have the scope in a steady rest, and so directed that the stake can just be seen at the left edge of the field of view, on line with a horizontal line passing through the center of the field. Have an assistant drive a second stake B, also 100 yards from the scope, to the right of stake A so that it can just be seen at the right edge of the field of view. The distance from A to B will be the diameter of the field at 100 yards. Twice this will be the diameter at 200 yards, and so on.

It is a law of optics that, other things being equal, the higher the power of the telescope the smaller the field of view.

A high-power scope is best for experimental work and rest shooting, as the error of aim is less. High power and fine cross-hairs are required for absolute alignment, particularly at ranges of 200 yards and over. High-power scopes are usually classified as those magnifying over 6 diameters. Scopes of over 20 diameters are seldom seen. High-power scopes have small, dark fields, and are unsuitable for either military or hunting use.

Low-power scopes, from 2 to 6 diameters, have brilliant and large fields. Objects can be seen distinctly in poor lights. The scope and rifle can be held steadily enough offhand so that the object aimed at remains in the field all the time, and is not continually bobbing in and out of view as is the case with a high-power scope held offhand. Low powers are best for military use, ordinary target shooting, and hunting. There is a little error of aim, particularly if the cross-hairs are very coarse, but the error is always much less than with iron sights.

A scope having a large object lens, and large eye lens in proportion to the distance between the lenses, will have a larger and brighter field than a similar scope of the same power but relatively smaller lenses.

The field of a very high-power scope appears dark; that is, the object viewed through it appears in a darker light than it does when viewed with the naked eye. On dark days such a glass is useless except against a light background, as, for example, a white target.

For making the object aimed at appear more distinctly, particularly in poor lights, a scope of low power should always be chosen.

The diameter of the field has considerable to do with the efficiency of the glass for the ordinary uses to which a rifleman will put it. With a glass having a large field the rifleman throws the rifle to his shoulder in such a manner that it points as closely as possible at the object he desires to hit. The object is then surely seen in some part of the field, and it is only necessary so to move the rifle that the cross-hairs superimpose their intersection on the point one desires the shot to strike. With a small field the rifleman may not be able so accurately to throw his rifle to his shoulder that the object will be included in the field of view, but after placing the rifle at his shoulder he may have to swing the rifle up or down, or to one side or another, until he finds the object in the field. This takes time and makes the catching of the aim slow. Moreover, if the field is very small the slight tremors of the rifle and scope, as the rifleman endeavors to hold them steady, may be sufficient to cause the object to be constantly appearing and disappearing in the field. Twenty years' experience with a large number and variety of scopes has shown that a field of view of at least 20 feet in diameter at 100 yards is essential if the object is surely to be seen in the field when the rifle is thrown to the shoulder by a skilled rifleman. This is a slightly larger field than obtains with any scopes at present made in the United States.

RELIEF

The relief of a scope is the distance at which the eye must be held in rear of the eye-piece in order to obtain the clearest view of the field and its largest diameter. It is greater with scopes than with other forms of telescopes, as it is necessary that the eye be held at some little distance from the eye-piece so that the eye-piece will not strike the eye when the rifle recoils. Also there is a certain latitude to it so that, for example, the eye may be held at any point from $1\frac{1}{2}$ to 3 inches from the eye-piece and still see the field at its best. This form of relief we will call the "longitudinal relief." A scope for use on a rifle having heavy recoil should have a long longitudinal relief so that the eye will not be endangered. Considerable latitude in the longitudinal relief is always desirable as the eye then does not have to be so accurately placed as to distance from the eye-piece in order to embrace the full field. Latitude thus makes for a quicker catching of the aim and for easier adaptability to the various firing positions.

The eye, for example, will be held much closer to the eye-piece naturally in the prone position than it is in the standing position.

There is also another form of relief which we will call the "lateral relief," that is, the distance which one may move his eye to one side or the other, or high and low, and still see the whole field of view. With iron sights there is no lateral relief at all, and one must get his eye exactly in the line of sight in order accurately to align the front and rear sights. With a telescope there is a certain latitude in this respect, and one may move his eye a little in any lateral direction and still see the whole field of view without disturbing the alignment of the cross-hairs. The more latitude there is to this lateral relief the quicker can the aim be caught, as the eye does not have to come exactly into the line of sight to obtain an accurate aim.

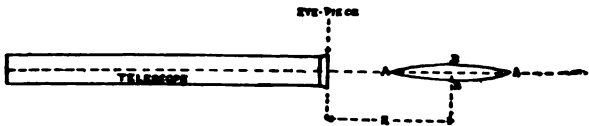

Fig. 60

- R — Longitudinal relief, 2 inches.
 A-A — Latitude of longitudinal relief, 2 inches.
 B-B — Lateral relief, $\frac{1}{4}$ inch.

In Fig. 60 the oval in rear of the eye-piece illustrates the relief of the scope. The drawing shows a longitudinal relief of 2 inches, and a lateral relief of $\frac{1}{4}$ inch, A-A being the longitudinal relief, and B-B the lateral relief. The eye can be placed anywhere within the oval and still see the entire field of view, and accurate aim be taken. The optical principle is such that the slight shifting of the eye from side to side through the lateral relief does not alter the line of aim, provided the cross-hairs of the telescope are in proper focus. That the cross-hairs are in proper focus can always be told by fastening the scope in a heavy vise. See first that the cross-hairs appear distinctly, then move the head from side to side through the lateral relief, and notice whether the cross-hairs move at all in their alignment on an object in front of the scope. If they do not move the focus is correct. A scope is absolutely useless unless the cross-hairs are in focus. Some scopes have the cross-hairs fixed immovable and in focus all the time. Others have a screw which allows them to be focused.

It will be obvious that with a relief, as illustrated in Fig. 60, aim

can be caught very quickly as the eye does not have to come to exactly one place to get perfect alignment. In fact, with such a relief, and a large field, aim can be caught very much quicker than with any form of iron sights, provided that the scope is so mounted on the rifle that the comb of the stock helps to lead the eye into the line of sight by offering a guide or measure as to about where to place the head to get the eye into the line of sight. As a rule the scopes manufactured in the United States have a rather small longitudinal relief, and entirely too small lateral relief. They are thus suitable only for slow target use and experimental work, such as accuracy testing.

LENSES

The field of view should be well defined and free from color fringes. This demands good achromatic lenses. This matter is always attended to by the makers with all but the very cheapest scopes, so that it needs no further attention other than to caution the purchaser against cheap scopes with ordinary lenses which will prove absolutely unsatisfactory, and probably introduce eye strain. The mounting of the lenses in the tube is of the greatest importance. Every lens has its optical center, and this may or may not correspond to, and be in alignment with, the axis of the tube. In fact, it is a very expensive matter to make a scope where these two centers coincide. Nor is it necessary for the ordinary uses to which a scope is usually put. If a telescope in which the optical centers of the lenses and the axis of the tube do not coincide be revolved on the axis of the tube, the cross-hairs, instead of remaining aligned on one spot on the target all the while, will pass in a circle over the field of the target. However, in aiming with such a scope the horizontal cross-hair assists one in holding the scope level, and prevents any tendency to rotate or cant, and thus the line of aim remains constant. But if a lens should start to revolve in its mounting in the tube the line of sight would be thrown off with it, and we would have a constantly changing line of sight as the lens revolved. An experience with a German scope several years ago will suffice to illustrate this point. The tube of this scope was divided into two portions. The rear portion revolved, screwing in and out for focus. The two portions were held fast by a set screw. No single set screw can be relied upon to hold with a high-power rifle of heavy recoil. In firing this scope on a high-power rifle it was noticed that the rifle was continually shooting high and to the right. In ten consecutive shots at 200 yards the point

of impact, starting at the center of the bull's-eye, moved two feet during the string towards 10 o'clock. Investigation proved that the rear portion of the tube was revolving during recoil, the set screw not holding it. This, of course, caused the rotation of the eye-piece, and as a consequence the line of sight went sailing up towards 10 o'clock. The glass was properly focused and the two portions then soldered up, and no further difficulty was experienced for a while, until finally the same thing occurred again, and after considerable investigation it was found that one of the lenses had become loose in its seat, being simply crimped therein by little brass flanges bent down over the edges of the lens, and this glass was revolving under the vibrations of recoil and shifting the line of sight a little with



Fig. 61

A Springfield sporting rifle with German telescope sight attached. A fine appearing combination to the novice, but absolutely useless for practical purposes

almost every shot. These faults are found in almost all German scopes, and make them absolutely unsatisfactory, although their optical properties are superb and often entice riflemen into purchasing them.

The lenses should all be mounted in barrels which are secured in the tube against rotating by means of a rib on the inside of the tube, and a slot cut in the barrel so that the barrel cannot rotate in the tube. Then there should be a similar rib in each barrel and a cut in the edge of the lens fitting over this rib. Then the lenses cannot rotate. Some arrangement must also be made to prevent the caps which secure the lenses in the barrels from coming unscrewed and making the lenses loose in their seats. It must be remembered that with the peculiar recoil of the high-power rifle single screws will always, sooner or later, become loose.

MOUNTINGS

The mountings of the scope are by no means the least important feature in connection with this instrument. It cannot be impressed

too strongly upon riflemen who have had no experience with scopes that the mountings must permit of very close and positive adjustment for both elevation and windage, and must have an arrangement for giving a clear reading of the various adjustments. The smallest movement or distance that the unaided eye can well measure or appreciate is just about .01 inch. Suppose we have Lyman sights on our rifle, the sights being 28 inches apart. With the eye alone we can adjust this sight as close as .01 inch. A change in adjustment of .01 inch on such sights means a change in the point of impact at 100 yards of 1.286 inch. This is plenty close enough in this case. But suppose we have a scope with a short tube (all modern scopes have short tubes) and the distance between the front and rear mountings is only 7.2 inches. Then the smallest adjustment we can see to make on this mounting, that is .01 inch, will cause a change in point of impact of 5 inches at 100 yards. In other words, with the ordinary crude sliding mountings often sold for telescope sights we cannot adjust our sights to shoot closer than five inches at 100 yards, and moreover we can at no time be sure that our rifle is going to shoot correctly at any given object closer than 5 inches. This, of course, will be absolutely unsatisfactory.

The only satisfactory method of adjustment of a scope mounting is by means of micrometer screws having small but positive readings. One who has never used a micrometer very often has the idea that such adjustments are weak and complicated. The fact is they are just the contrary, being nothing more than large, strong screws with the scales engraved on them. A mounting with micrometer adjustments is the simplest and strongest of all kinds. With micrometer adjustments we can easily arrange our mountings so that both the elevation and windage adjustments can be positively moved and read to a change in point of impact of half an inch at 100 yards, or in other words half a minute of angle.

A scope has two mountings, front and rear, corresponding to the front and rear sights. The front mounting has no adjustment, but holds the scope so that it can be moved slightly at the rear end in any direction. The rear mount should have adjustments for both elevation and windage. The only scope mountings made in the United States, or in fact in any country, which are at all satisfactory, are those made by the Winchester Repeating Arms Company — the regular front mounting and the No. 2 rear mounting. The front mount consists of a ring around the tube of the scope, and is secured to the

barrel by means of a dovetail base and a screw. The tube bears on two convex surfaces placed 120 degrees apart inside the ring. In the bottom of the inside of the ring, and placed at 120 degrees from each of these convex surfaces, is a bevel-nosed plunger which engages in a long groove on the under side of the tube, and keeps the tube from rotating but allows it to move longitudinally. This device insures the axis of the tube remaining constant, once it is adjusted.



Fig. 62

Springfield rifle remodelled by A. O. Neidner, and fitted with Winchester telescope sight and Winchester mountings

The shape of the rear mount is oval instead of circular, as in the case of the front mount, and is such as to allow ample play to the tube for elevation and windage adjustments for different ranges. Two springs, one exerting pressure vertically and the other horizontally, hold the tube in contact with the elevation and windage screws. The elevation and windage are set by micrometer screws reading to .001 inch. The division markings on the adjusting screws and mounts are enameled in red so as to make it easy to read them quickly and accurately. When the mountings are placed 7.2 inches apart one point of adjustment on either of the adjusting screws is equivalent to a change in point of impact at 100 yards of half an inch.

Small longitudinal dovetail bases are screwed to the barrel of the rifle the proper distance apart, and the bases of the mountings slip over these, being secured from slipping by thumb screws in the base of the mount. By loosening the thumb screws the mountings can be removed from the bases, thus removing the scope from the rifle, leaving only the small dovetail bases screwed to the barrel. Reference to the illustrations of the Winchester scope and mountings will make this description clear.

The Winchester mountings as described are very satisfactory, in fact

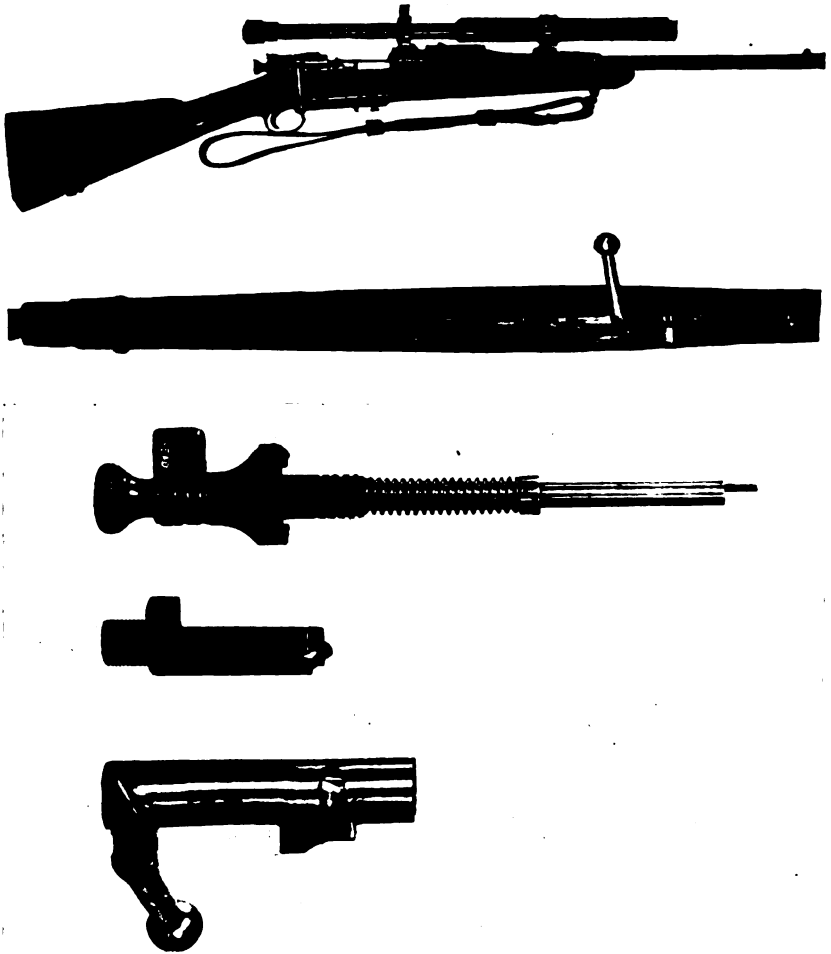

Fig. 63

Views of Neidner .22-caliber Springfield magazine rifle, showing action and details of bolt. In this rifle the cartridge is not loaded into a holder, but is loaded direct from a .22-caliber magazine into a barrel regularly chambered for the .22-long rifle cartridge. The telescope sight is attached to the rifle with Winchester mountings and Mann taper dovetail bases.

almost ideal, in all respects save one. The method of attachment to the barrel is not altogether satisfactory, although in most cases it works very well. It is very necessary that some arrangement be had whereby the scope can readily be removed from the rifle, but this

arrangement should be so positive and accurate that when the scope is removed it can be put back again and still be in absolutely accurate adjustment. Otherwise it will be necessary to sight the rifle in every time the scope is removed and replaced. Also the method of attachment should be absolutely rigid so as to allow no movement during firing, or from shot to shot. The Winchester method of attachment does not quite accomplish this, although it comes very near to it. Sometimes there will creep into the mounting an error of as much as two minutes of angle due to the lack of rigidity in this method of attachment. Either the retaining thumb screws become loose during firing, or the screws are sometimes screwed up tighter than at other times, thus causing a slight variation of the setting of the mounting on the base. Also the bases themselves, being secured to the barrel by screws alone, sometimes work loose under sharp recoil. Little trouble will be experienced, however, until we place the scope on a rifle of very sharp recoil, like the .30-caliber Model 1906.

A few years ago the late Dr. F. W. Mann invented a method of securing the mountings to the barrel. The mountings are so arranged as to fit on taper dovetails securely fastened to the barrel, by a driving fit which gets tighter instead of looser from recoil. The dovetail base is not only screwed, but also soldered on to the barrel so that it cannot possibly become loose. The base is dovetail in shape, and also tapers slightly from front to rear, the taper on both sides being at an equal angle with the axis of the bore. The under side of the mounting is cut out to fit over this base, and fits on it from the rear, the mounting sliding over the base, and wedging up on the taper to a positive fit. This gives fit which is absolutely secure, must come back to exactly the same place each time the mountings are removed and replaced, and which wedges tighter the more the recoil. Figs. 63 and 64 show the Mann taper dovetail base. A number of Winchester scope mountings have been altered by Mr. A. O. Neidner, the skilled riflemaker, so as to be secured to the barrel by means of the Mann taper dovetail bases, and these have proved perfect for the purpose, there being no error at all. In taking these mountings off the bases to remove the scope from the rifle it is necessary to drive them off with a piece of hard wood, using light, sharp blows, and to drive them on in the same manner. This may seem rather crude, but experience has shown that it is the only really satisfactory way if accuracy and absolutely positive results are to be secured. Before obtaining these taper dovetail mountings there was always an error

in point of impact from day to day in my experimental work, sometimes amounting to as much as 2 minutes of angle, which I could not account for. With these mountings this error has entirely disappeared. For example, one day I would shoot a rifle in test at 100 yards and obtain a certain group with it, located at a certain point on the target. The next day I would make a similar test and would obtain another group about the same size as the first group, but perhaps as much as 2 inches away from the location of the first group, aim, sight adjustment, ammunition, everything exactly the same. This error was due to the error of the scope mounting, and the adoption of the Mann taper dovetail bases entirely removed this error.

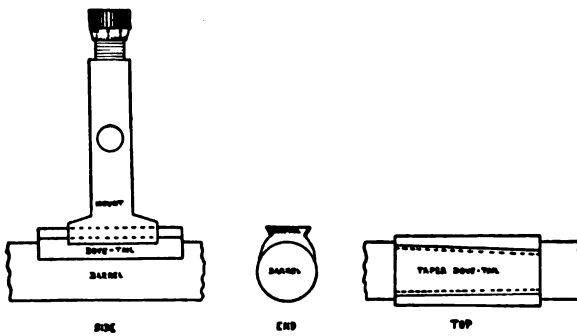

Fig. 64

The Mann taper dovetail method of attaching the telescope sight mounting to the barrel

To test the mountings of a scope, the rifle should be firmly fixed in a very heavy vise where it will be absolutely immovable, and in such a manner that it can be aimed at a target at some distance off while thus immovably held. The target should preferably be at an even number of hundred yards. With the scope on the rifle, aim it at a spot on the target and screw the rifle up tight in the vise. Then remove the scope from the rifle without removing the rifle from the vise, place the scope back again on the rifle, and look through it at the target, noting whether the point of aim has moved in the slightest. If, after a half a dozen trials there has been no change in the point of aim on the target, the method of mounting the scope may be taken as positive and accurate. Place a mark on the target 10 inches above, and another 10 inches to the right of, the first aiming point. With the scope adjusted for the first aiming point, give the rear mounting additional elevation to move the point of impact up

10 inches. Look through the scope and see if it is now aimed at the upper mark. If so, the elevation adjustment is positive and accurate. Bring it back to aim at the original point, and adjust the mount to move the point of impact 10 inches to the right, look through the scope and see if it is now aimed at the right-hand mark, to prove the windage adjustment. With the scope aimed at the mark, move the eye from side to side a little through the lateral relief of the glass and see if the cross-hairs move on the target. If they do not, the cross-hairs are in focus and there is nothing the matter with the scope which would interfere with the accuracy. If they do move, then the cross-hairs should be carefully focused, moving them back and forth until they are perfectly distinct and yet moving the eye from side to side does not change the aim on the target. It is always well to repeat these tests with a scope every few months to see that everything is working all right. You are then sure that any error that may come up in the course of shooting is not an error of the aiming device.

THE WINCHESTER STYLE A, 5-POWER TELESCOPE SIGHT

This is the most modern and satisfactory scope manufactured in the United States. In fact it is the only one which the writer has found that is really satisfactory for use on a high-power rifle. Although by no means ideal it is a very good glass, and the best that can be obtained at the present time. The lenses are $\frac{3}{4}$ inch in diameter, and the tube $15\frac{7}{8}$ inches long. The longitudinal relief is 2 inches and the latitude of longitudinal relief about 2 inches. The lateral relief is only about $\frac{1}{8}$ inch, which is rather small, and trouble is at times had in holding the eye steady enough to keep the full field in view. This trouble is seldom experienced in target shooting but is at times rather aggravating in hunting. The eye-piece is of the terrestrial type, and is adjusted for focus by simply loosening the locking sleeve and turning the eye-piece until the proper focus is obtained, and then screwing up the locking sleeve. When the eye-piece is adjusted to suit the user's sight, no further change should be made in it, focal adjustment for different ranges being obtained by adjusting the objective lens.

The micrometer adjustment of the objective lens provides a simple and accurate means for positive and minute relative adjustment of the lenses and cross-hairs required for accurate focusing of the image at the cross-hairs for various ranges. In using this micrometer focus

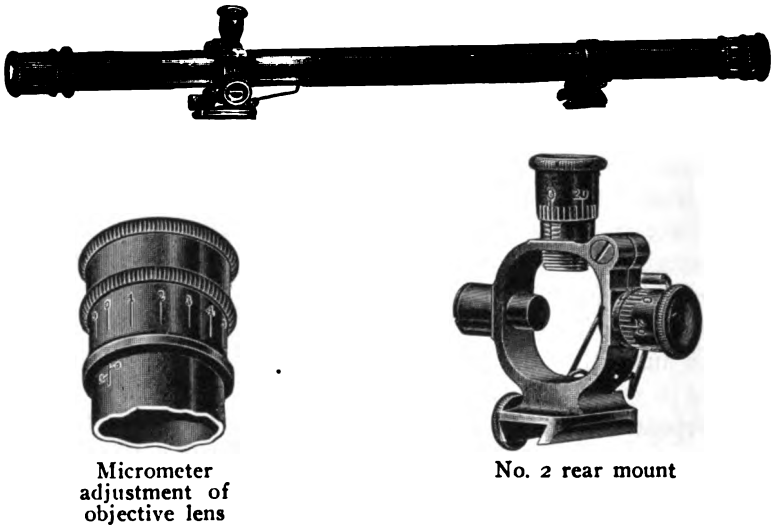

Fig. 65

Winchester type A, 5-power telescope sight and mountings

adjustment always start at zero and screw the sleeve towards the rear. The following table shows the number of turns and divisions required to give perfect focus at the various ranges.

Range	Turns	Divisions	Range	Turns	Divisions
50 feet	0	0	50 yards	1	5½
75 feet	0	8	100 yards	1	9½
100 feet	1	1½	200 yards	2	1½

From 200 yards up, the focus of the objective lens is universal, and therefore requires no change in adjustment. For ordinary purposes the objective may be set in focus for 50 yards, and will answer very well for all distances from 25 yards up, but for constant use at any one range the objective lens should be carefully focused to avoid eye strain. In turning the micrometer screw to focus the objective lens, the lens itself does not turn but slides in the tube, being held from turning by a rib.

The cross-hairs are held in a reticule, and as opinions differ as to the best form of cross-hairs or other sighting points, five different styles of reticules are furnished; namely, single and double cross-hairs, triangle, aperture, and post. The single cross-hairs are almost always to be preferred, except only for military target shooting at bull's-eye targets, when the post is preferable, being shaped very

similar to the front sight on the United States rifle, Model 1903, and aim being taken in the same manner, getting the post so superimposed on the image that the top of the post appears just below the bull's-eye. These reticules are interchangeable, and one can be substituted for another without difficulty (see below).

The mountings for the Winchester scope have already been described. The tube glides through the mountings when the rifle recoils and has to be drawn back to a stop after each shot. This sliding of the scope is almost absolutely necessary. If it were rigidly fixed in the mountings it would receive too much of the force of recoil and would quickly become damaged. Also the tube sliding forward with recoil serves to carry the eye-piece away from the eye, so that there is no danger of the eye-piece striking the eye. If it were not for this sliding feature it would be necessary to have at least 5 inches longitudinal relief to a glass intended for use on a high-power rifle of heavy recoil, and this would materially reduce the size of field. The diameter of the field of this scope at 100 yards is 17 feet.

DIRECTIONS FOR REMOVING LENSES FROM WINCHESTER TELESCOPE SIGHTS

To secure the most satisfactory results from an instrument of this kind, it should be taken apart only when absolutely necessary.

Front or objective lens. Remove the adjusting sleeve cap. Unscrew the adjusting sleeve about $\frac{1}{4}$ of an inch. Then return it to its original position. This leaves the rim of the lens cell exposed so that it can be pulled out. It is not advisable to remove the lenses from their seats in the cells, as they are liable to injury from improper seating.

Reticule (cross-hairs, etc.). Loosen the reticule retaining ring screw, situated on the left side of the tube near the rear end, by turning it *inward* as far as it will go, using the screw-driver furnished. The reticule holder may then be shaken out rearward by holding the tube vertically. If it sticks, rap the end of the tube gently on a smooth wood surface. After removing the reticule holder from the tube, the reticule disc, carrying the cross-hairs, or other form of reticule, may be removed through the slit provided for it. In replacing the reticule in its holder make sure the side on which the wires are soldered is toward the rear and the projection on the side of the disc is seated in its slot, so that when reassembled the reticule will stand upright.

Middle or inverter lens (style A or B, 5-power). Loosen the middle

lens cell retaining ring screw, situated on the left side of the tube near the middle, by turning it inward as far as it will go. Then reach into the rear end of the tube with the finger or any hooked instrument and, engaging the notched end or the rear retaining rod, withdraw it with the rear diaphragm and middle lens cell attached. Replace in reverse order, making sure that when the retaining screw is tightened the center of its head is *exactly* in line with the line scratched across the slot in the tube.

The Winchester Style A, 5-power telescope sight is excellent for target shooting, particularly for Schuetzen rifles. I have had excellent results with it on a .30-40 Winchester single shot rifle. In fact I have used one of these glasses for over ten years, and have had it mounted at one time or another on over 20 rifles. It has always given perfect satisfaction except for the little trouble with the method of mounting on the barrel, as already noted, and the cross-hairs are so thick that it is difficult at times to get an absolutely accurate aim. The cross-hairs should be made thinner. This glass has also been used by a number of our most skilled military rifle shots for long range shooting on the United States magazine rifle, Model 1903, with almost perfect results. The rifle can be used only as a single loader, and the scope must be pushed forward a little each time the bolt is pulled up so as to escape the bolt handle. On the 1903 rifle the mountings should be placed only 6 inches apart in order to give the rear mounting sufficient scope to permit of its adjustment to the extreme range of 1200 yards. When the mountings are placed 6 inches apart, one point adjustment on either elevation or windage screws moves the point of impact .6 inch for every hundred yards of range. On other rifles the mountings should be placed 7.2 inches apart, then one point of elevation or windage is equivalent to a change of point of impact of half an inch for every hundred yards of range.

It is always preferable to have the telescope mounted on the top of the barrel and as low down as possible, so that the eye-piece will come as nearly as possible to the same point that the eye-piece of a tang sight, like the Lyman, would come. Then one can take advantage of the comb of the stock quickly to direct the eye into the line of sight, and can also press the cheek against the side of the stock, as he should, to hold the eye steadily in the line of sight. If the scope be mounted on one side of the barrel in order to be able also to use the iron sights at the same time, or if compelled to do so because the rifle ejects its fired shells out of the top of the receiver, one must

forego all this advantage of having the comb to direct the eye into the line of sight, and the cheek rest on the side of the stock. The eye bobs around in the line of sight, and it is very difficult to hold steadily. If necessary to mount the scope very high above the barrel, a cheek pad, made for use on shotguns, can be laced to the stock, thus raising the comb of the stock. For experimental firing the scope should always be mounted on top of the barrel, centrally over the axis of the bore. In fact I would advise that a telescope sight be not used on rifles that do not permit of its being so mounted, because the results are bound to be unsatisfactory, it being impossible to hold the rifle with any degree of steadiness when looking through the scope, except when shooting from a rest.

When it comes to a scope for all around use, target shooting, big game shooting, and military work, the Winchester scopes have many faults which makes them really unsuitable. Besides those already noted, the field is too small, the lateral relief is too small. The power should be less, about 3 power, and the lenses larger to permit a much larger and brighter field of view. The lenses should be more securely fastened in their cells against possible rotation. Greater longitudinal relief would be desirable. All these points, of course, were not fully appreciated when the Winchester scope was placed on the market.

THE IDEAL TELESCOPE SIGHT

Throughout this chapter the various features of the scope have been discussed, the faults and the desirable features pointed out. If all these features were combined at their best in one glass we would have the ideal telescope sight. Thus our glass would be short and of rather larger diameter than the glasses now seen. The tube would be very strong so as to stand the hard knocks of real service. The lenses would be strongly secured in the tube against coming loose and also against rotating. The magnifying power should be about 3 diameters. The diameter of the field at 100 yards should be at least 30 feet. The longitudinal relief should be at least $3\frac{1}{2}$ inches, with a latitude of at least 3 inches. The lateral relief should be at least $\frac{1}{4}$ inch. The field should be very bright, and without color fringe. Focus for clearness of vision and for distance should be arranged for exactly as in the Winchester scope. The mountings should be similar to the Winchester No. 2, and should be secured to the barrel by means of the Mann taper dovetail bases.

With such a scope the rifleman throws the rifle to his shoulder and

instantly catches the aim. As his eye does not have to get exactly in the line of sight, as is the case with iron sights, he gets his aim much quicker with the ideal scope. The object is seen clearly magnified, and even brighter than when viewed with the naked eye. It is not necessary to get two sights into line, but only to move one sight, the cross-hairs, so as to have them superimpose on the magnified image. When the target is clearly seen it is much easier to get a quick aim at it than when it is indistinct. Every military rifleman knows how much quicker he can sight on a well-lighted bull's-eye target than he can on a drab-colored silhouette. As the target is magnified, and the cross-hairs are thin, much more accurate aim can be taken than with coarse iron sights. In fact the ideal scope is a very much better aiming instrument than any other form of sight under all conditions. Its only disadvantage is that it is a delicate instrument, set up on top of the rifle where it is liable to damage by a fall, or by catching in limbs of trees, etc. This liability to damage can hardly be eliminated except by placing a heavy metal cover over the instrument, which would greatly increase the weight of the rifle.

TARGETS FOR TELESCOPE SIGHTED RIFLES

The conventional bull's-eye target is not very satisfactory for use with the scope. It is difficult to aim accurately at the center of the large magnified black bull's-eye as the black cross-hairs blend with the black of the bull and are not clearly defined. Particularly if the shooting is to be of an experimental character, or if it is to be a test of rifle or ammunition, it is much better to use a specially prepared target consisting of a bull's-eye with a large white center. For this use, with the coarse cross-hairs of the Winchester type A, 5-power scope, I have standardized on a 100-yard target having a 6-inch black bull's-eye with a 4-inch white bull inside it. This is easiest made with the materials at hand anywhere by using a compass, and drawing two circles on the paper target, one circle 4 inches in diameter, and the other 6 inches in diameter. Then take a small water-color paint brush, and with ink paint the space between the two lines, making a ring an inch in diameter. For other ranges use circles proportionately larger or smaller. The cross-hairs are then made to intersect on the white bull's-eye inside the black circle, and the eye can do this with almost absolute accuracy.

CHAPTER X

BULLETS

THE first bullets were round and made of pure lead. They were pounded down the bore of the muzzle loader by the ramrod, and it was a difficult task to get them seated all the way down on the powder, particularly when the bore was a little dirty from firing. It did not take the American frontiersman long to get disgusted with this method that had prevailed in Europe up to about 1700. In Europe it was not often that one fired many shots a day, but in America game was very plentiful, and the rifleman had to be constantly loading his rifle. As a consequence some one, probably one of the Lancaster riflemakers, invented the greased patch. The bullet was made a little smaller than usual. A round patch about the size of a silver dollar, made of either linen or thin buckskin, and greased with deer tallow, was laid over the muzzle of the rifle, and the bullet pressed down on top of it with the thumb. The ramrod then seated this patched bullet easier, and a few wangs with the ramrod when it was fully seated on the powder sufficed to upset the soft lead ball so that it filled the grooves perfectly. The patch of course left the bullet at the muzzle.

This form of bullet and method of loading sufficed very well until about 1820, when riflemen began to press forward into the open prairies of our Central States. Here long shots were the rule, and it was quickly found that the round ball was a very poor long-range missile. It lost its velocity very quickly, and it lacked in penetration for the larger game found in the West. About this time the long conical bullet was invented abroad, and riflemakers in this country were not slow to adopt it, particularly for Western use, as it so greatly increased the range and killing power of the rifle. The conical bullets for the early muzzle loaders were all made small so that they could be driven home easily, they had grooves for lubricant like the present lead bullet, and the base had a hollow cavity in it so that the gases of the burning powder would cause the base of the bullet to expand and fit the rifling to the bottom of the grooves. Sometimes the hollow

base contained a cone-shaped plug to insure positive expansion of the bullet. These bullets continued in use up to the introduction of the breech loader, and we even see this type in use today in some revolver cartridges.

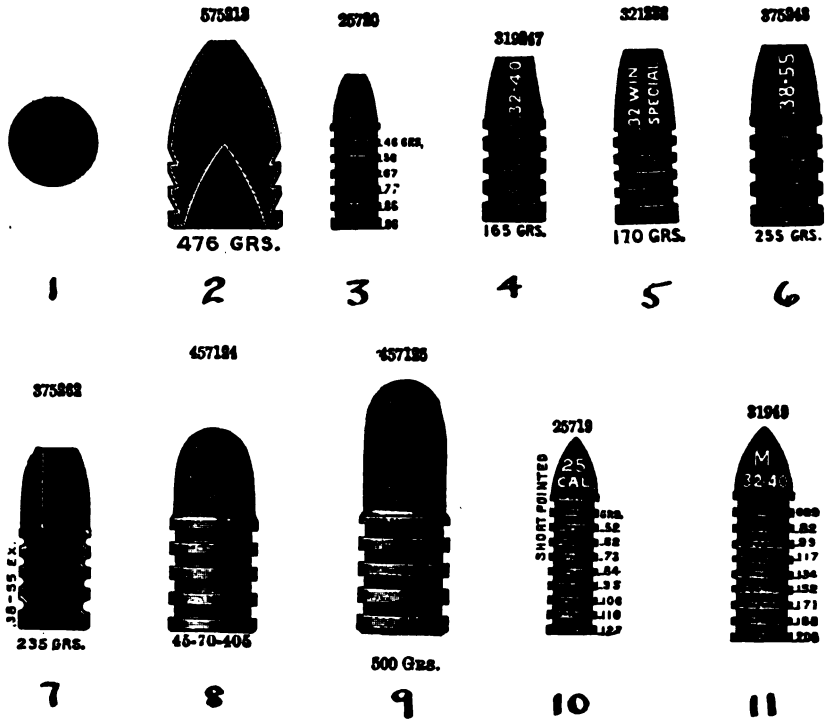

Fig. 66

1. Round bullet as used in the first muzzle loaders.
2. Conical muzzle loading bullet with cavity in base to insure expansion on firing, and filling the bore gas tight.
- 3 to 6. Lead alloy bullets for black powder rifles. Can also be used with low pressure smokeless powder.
7. An express bullet with hollow point to insure its expanding on striking game.
- 8 and 9. The 405 and 500 grain bullets for the .45 caliber U. S. Springfield rifle.
- 10 and 11. Sharp point bullets for shooting small game without mangling.

With the introduction of the breech loader came the full-sized bullet made of lead alloyed with tin to harden it slightly, as we see it today. There has been practically no change in the lead bullet for the breech loader since it was designed shortly after the Civil War. The only improvement worthy of mention is that introduced with some

special loads, and for which Mr. H. M. Pope and Dr. W. G. Hudson deserve credit. The forward portion of the body of the bullet was made bore diameter so that it would ride on top of the lands when the cartridge was loaded, and thus serve to straighten the bullet up in the chamber and insure its axis being in line with the axis of the bore before firing. The rear portion of the body was then made full groove diameter so as to fit to the bottom of the grooves and prevent the escape of gas past the bullet. These bullets showed quite a little superiority as regards accuracy over the old type with straight cylindrical body.

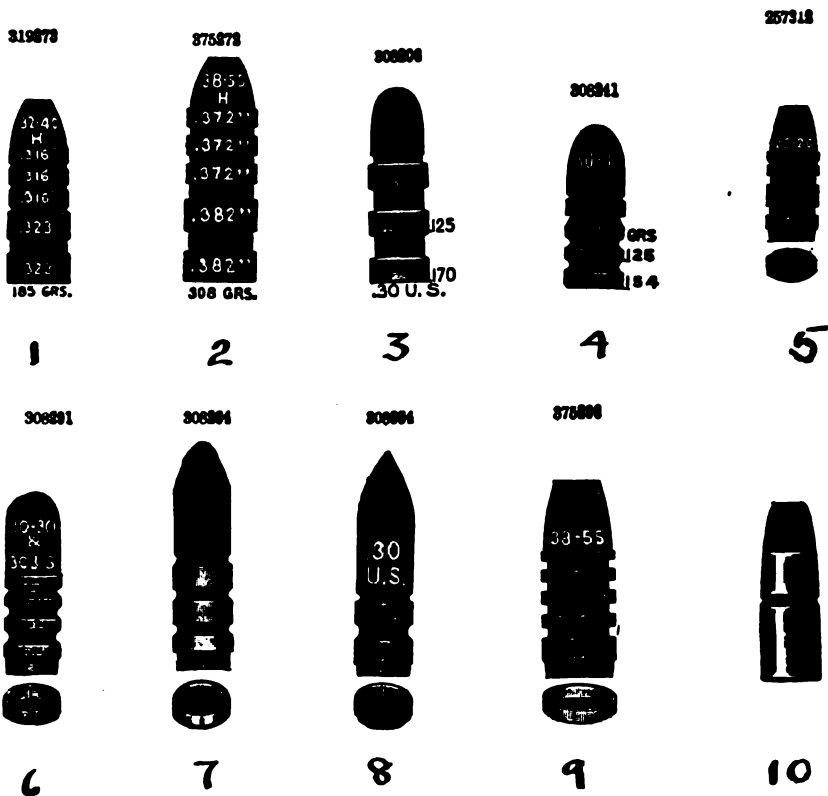

Fig. 67

- 1 and 2. The Hudson-Ideal, two-cylinder bullets for target shooting.
3. The Kephart bullet, first successful lead bullet to be used in high power rifles.
4. A popular lead alloy bullet for short range in .30-caliber rifles.
- 5 to 9. Ideal gas-check bullets for medium high velocity with smokeless powder.
10. Soft-point, jacketed bullet for .32 Winchester special rifle.

The points of all these lead bullets were made either flat, rounded, or rather blunt ogival. Sharp point bullets were later introduced, but always in light weights with a view to their use on small game rather than to cut down the resistance of the air.

With the introduction of high-pressure, smokeless powder, and the increasing of velocities to around 2000 feet per second, a new material for bullets became necessary. The lead bullet caused many troubles with high-pressure powder. The base of the bullet would become fused or melted by the heat of the burning powder, and the bullet would lead the barrel badly. This led to the introduction of the jacketed bullets. These bullets have a core of lead enclosed in a jacket of copper, cupro-nickel, tin-plated copper, or mild steel. Very few steel jacketed bullets were ever made in this country, and I know of none being made today except by the Ross Rifle Company for special uses. The bullets made for American sporting rifles having velocities not exceeding 2200 feet per second are almost always made of copper plated with tin or nickel, to keep it from corroding. The United States Government bullets, and those for kindred commercial arms, are jacketed with cupro-nickel—an alloy of copper and nickel. Some few modern bullets such as those for the Newton rifles, and for the .250-3000 Savage rifle are jacketed with pure copper. A pure copper bullet seems to deposit less metal fouling in the bore of the rifle than those made of other materials.

At the start the metal-jacketed bullets contained grooves for lubricant, but it was quickly found that this was not necessary, either as a lubricant for the bullet itself, or to make the cartridge waterproof. The grooves in the bullets were therefore discontinued, and the modern jacketed bullet is perfectly smooth, or else has only one shallow groove in which to crimp the shell. Where a cartridge is to remain loaded a long time, as with military ammunition, it is much better to have the neck of the shell just the diameter of the bullet inside, and to crimp the shell on to the bullet to hold the latter immovable in the shell. But where one reloads his own ammunition it is better to have the shell slightly smaller inside the neck, and force the bullet into the small neck to be held friction tight, as a little better accuracy results by following this method. But cartridges loaded in this manner are apt to split at the neck of the shells after several years storage. The brass neck of the shell under constant tension literally becomes tired and splits.

Military jacketed bullets have the jacket completely covering the

point of the bullet, the core being inserted at the base, and the jacket crimped over the base. It was soon found that such bullets were unsatisfactory for large game shooting. They penetrated straight through animal tissue without causing much damage, and expended most of their energy beyond. The cartridge companies, however, soon came to the rescue of the sportsmen and put out what is known as the "soft-point" bullet, which has a little lead exposed at the point. The base of the bullet is completely jacketed over, the lead core being inserted, base first, into the jacket, and the jacket only coming up

.30 Army 220 grain soft point bullets



Fig. 68

Showing the expansion of soft-point bullet

to within about $\frac{1}{8}$ inch of the point of the bullet. Such bullets expand well on animal tissue, taking on a mushroom shape, and causing serious wounds. It has been found that the killing power on large game of a 220-grain, soft-point, jacketed bullet of .30 caliber driven at a velocity of 2000 feet per second is just about equivalent to that of the old 500-grain, .45-caliber, lead bullet driven at a velocity of about 1300 feet per second. The soft-point, jacketed bullet should therefore always be used for big-game shooting, and the full-jacketed bullet for target shooting, or for small game, particularly where it is desired to kill the small game without destroying more meat than is absolutely necessary, or tearing a large hole in the skin. Soft-point, 30-caliber bullets on broadside shots at deer usually penetrate completely through the animal, making a hole about 3 to 4 inches in diameter at point of exit, and spoiling the meat for about 5 inches around the wound. On small game such as squirrels, grouse, woodchucks, and rabbits they are liable to blow the whole animal to pieces.

After the new high-power rifles with their jacketed bullets had been in use for several years, riflemen began to complain that the bullets were wearing out the barrels. We know now that this was not so, and that the wear was caused partly by gas cutting at the breech due to the hot burning powder and the poor bullet fit, and partly by a lack of knowledge as to how to clean a high-power rifle

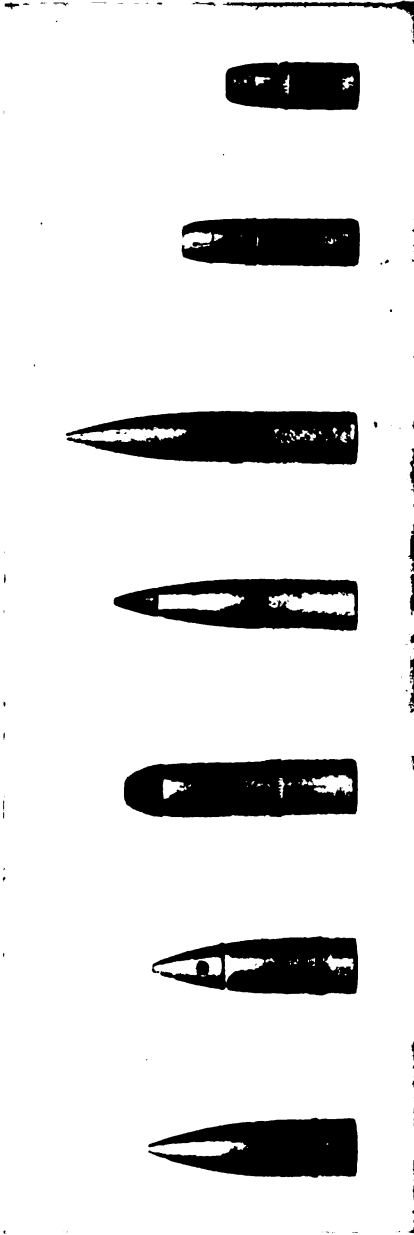

Fig. 69

Bullets in common use in American rifles. In order from left to right:

- .30 caliber U. S. Model 1906, 150-grain, service bullet.
- .30 caliber U. S. Model 1906, 150-grain umbrella expanding bullet.
- .30-40 Krag, 200-grain, soft-point bullet.
- .280 Ross, 142-grain, copper tube, expanding bullet.
- .280 Ross, 180-grain, full jacketed target bullet.
- .25-36 Marlin, 117-grain, soft-point bullet.
- .25-20 Repeater, 86-grain, soft-point bullet.



Fig. 69a

- .405 Winchester, 300-grain, soft-point bullet.
- .35 Remington auto-loading, 200-grain, soft-point bullet.
- .33 Winchester, 200-grain, soft-point bullet.
- .30-30 W. C. F., 170-grain, soft-point bullet.
- .45-70 Springfield, 500-grain, lead bullet.
- .45-90 Winchester, 300-grain, soft-point bullet.
- .38-55 Marlin, 255-grain, lead bullet.
- .401 Winchester self-loader, soft-point bullet.
- .32-20 Winchester, 115-grain, lead bullet.

barrel. A decided demand grew for a lead bullet which could be used in the high-power rifle so as not to wear out the bore, and it was also wanted for cheap reloading and for small game. The first satisfactory results in this direction were secured by Mr. Horace Kephart, who designed the bullet known as the Ideal Bullet No. 308206 for .30-caliber rifles, and obtained excellent results with it in a .30-40 rifle with a light charge of Du Pont No. 1 smokeless rifle powder. It was afterwards found that any bullet would do satisfactory work in a high-power rifle having a quick twist, provided it was made of a hard alloy of about 1 part of tin to 10 parts of lead, was made from $\frac{1}{1000}$ to $\frac{3}{1000}$ of an inch *larger* than the groove diameter of the barrel, and was used with a light charge of low-pressure smokeless powder giving velocities not over 1500 feet per second. Such loads with light bullets proved very satisfactory for gallery and small-game shooting, and with slightly heavier bullets for practice up to 200 yards.

The increase in the popularity of military rifle shooting, and the cost of the full charged military cartridge, as well as the mistaken belief that the jacketed bullets were wearing out the barrels, led to the demand for a lead bullet that could be used with high-pressure powder to give increased velocities, so as to be satisfactory for target use up to 600 yards. After considerable experimenting on the part of the Ideal Manufacturing Company, ably assisted by Dr. W. G. Hudson of the Du Pont Company, the former company brought out the series of Ideal gas-check bullets for use at high velocities in high-power rifles. These bullets are cast of a hard alloy, made several thousandths of an inch larger than the groove diameter of the barrel that they are intended to be used in, and then have a small, cup-shaped, copper disk seated on the base. This disk acts to keep the hot powder gases from burning or fusing, and melting the base of the alloy bullet and deforming it, thus destroying accuracy. These bullets have proved very satisfactory, being quite accurate up to 500 yards, and if extreme care be taken in loading they will be found fairly satisfactory at 600 yards in the .30 caliber government arms. The rifleman can cast and prepare these bullets himself, and the expense is greatly reduced. The powder charges used are usually several grains less of the same powder used with the regular jacketed bullet, so as to give a velocity of about 1800 feet per second. When attempts are made to speed these bullets up much higher than this inaccuracy usually results.

It seems to be a well-established fact that with ordinary lead or lead alloy bullets accuracy and good results cannot be obtained at velocities

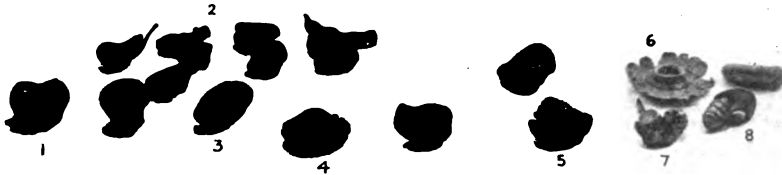

Fig. 69b

Bullets taken from big game, showing mushrooming and deformation:

- | | |
|-------------------------------|---|
| 1. .45-70-330 from deer. | 5. .38-55-255 lead, from black bear. |
| 2. .30-172 Newton, from deer. | 6. .45-70 fired against steel plate. |
| 3. .45-70-436. | 7. .280 Ross, steel jacket, hollow point. |
| 4. .45-70. | 8. .280 Ross. |

over about 1550 feet per second, and that when smokeless powder is used the alloy should be very hard and the bullet slightly larger than the groove diameter of the barrel; that velocities up to about 1900 feet per second can be obtained with good accuracy from hard lead alloy bullets when the base of the bullet is protected by a copper, gas check disk, but that when velocities reach 2000 feet per second accuracy can only be obtained from a metal-jacketed bullet.

My own experiments and experiences show that the jacketed bullet is almost always advisable. I have found them quite a little more accurate than the lead bullets. With lead bullets, particularly with calibers below .32, it is necessary to experiment a lot to find just exactly the right kind of bullet, and the right kind of alloy to use to get the best results. It is a fact that as a lead alloy ages it grows slightly harder. A change of the powder charge almost always makes one start all over again to find the right temper for the bullets, and so it goes on with one endless round of experiments when one uses lead bullets. Gas-check bullets, and those over .38 caliber, are a little better, not so much experimenting being necessary to attain and maintain the best accuracy. All lead bullets are liable at one time or another to lead the bore; that is, to deposit flakes of lead in the bore. The metal fouling deposited by jacketed bullets can be easily dissolved with the ammonia solution, but riflemen have yet to find a really good method of removing lead from the bore of a rifle. Mercury will help a little, but is not entirely satisfactory. Metal-jacketed bullets are also much easier to load. In fact in every way, except that of expense, metal-jacketed bullets are greatly superior to the lead-alloy bullets.

Up to about 1905 no attention had been given to the point of the bullet, with a view to reducing air resistance. It was believed that the point did not figure much in this respect, and bullets were made with round, blunt ogival, and flat points. The flat-point bullet was designed for tubular magazine repeating rifles where the point of one bullet rested against the base and primer of the cartridge ahead of it in the magazine. The Germans were the first to introduce what is known as the "Spitzer" bullet. Spitzer simply means pointed, and a spitzer bullet is one with a long, sharp point, usually drawn on a curve of six or more diameters. The air offers very much less resistance to such bullets than to the old blunt points, and as a consequence the velocity of the former does not fall off nearly as quickly, and their time of flight over all ranges is much less. This is a decided advantage as the trajectory is of course lowered, and the speed of the bullet being greater there is less time for wind to act on it, therefore, there is less deviation from winds. This spitzer bullet is the modern bullet, and all types of cartridges will be forced to come to it in the near future. Already it has been adopted by the armies of every nation, and by almost all progressive sportsmen. Several of our ammunition companies have succeeded in making satisfactory soft-point bullets in spitzer shape by ending the thick jacket a short distance back from the tip of the point and jacketing the tip itself with a thin, softer jacket. It has been found that if the tip be left entirely unjacketed or unsupported, as is done with the ordinary soft-point, jacketed bullet, the soft point under the extremely high velocity and high pressure has a tendency to upset and flow back, the bullet really making itself a blunt point before it reaches the target. Also unprotected, soft-point spitzer bullets are very liable to injury and bad dulling of the point, even in the original ammunition box, or in the belt or pocket of the rifleman.

The Germans who introduced the Spitzer bullet by adopting it for their military rifle, made it to weigh 154 grains in 8 mm. This is equivalent to 150 grains in .30 caliber. The bullet was made light so as to give an extremely flat trajectory over military ranges. Our military shots soon found that these light bullets were not quite so good for long range shooting as a slightly longer and heavier bullet. Our service .30-caliber bullet weighs 150 grains, but the long range target shot prefers one weighing 180 grains for shooting at 800 and 1000 yards. The longer bullet is slightly more accurate at these ranges and it is quite a little less affected by winds. At the same time it

has been found that 150 grains is a little too light for a satisfactory game bullet in .30 caliber. The light bullet does not always penetrate deeply enough, particularly when the rifleman obtains only a rear shot at large game, and it is not so good a bone smasher as the heavy bullet. Where a year or two ago riflemen used the 150-grain, soft-point or expanding spitzer bullet for game shooting in their .30-caliber, Model 1906 rifles, many of the better informed ones are coming to use the 180-grain bullet, and getting much better results.

CHAPTER XI

CARTRIDGES

IN this chapter are described the various cartridges adapted to American rifles. All the popular and modern cartridges have been listed, but it has been necessary to exclude certain of the older and less popular, black-powder cartridges which have become obsolete. Each cartridge is fully described, together with a list of the rifles to which it is adapted, the use to which it is best adapted, and the game for which it is suitable. All the data available regarding the factory cartridge are given.

In many cases detailed instructions for the loading of special leads is given. These leads are recommended because in many cases they are more powerful, more accurate, or less powerful and hence adapted for gallery use or for smaller game, than the factory cartridge. In every case these leads have been tried out, the breech pressures of the heavier loads being taken, and they may be regarded as safe and reliable if the instructions and cautions accompanying them are carefully complied with. Where Ideal bullets are recommended the reader should consult the "Ideal Handbook" on reloading, which illustrates and describes all the Ideal bullets. It can be procured for four cents in stamps by addressing the Ideal Manufacturing Company, New Haven, Connecticut. Before attempting to reload any cartridge the reader should make himself thoroughly familiar with the chapters on modern rifle powders and reloading ammunition. In connection with the cartridge one should also consult the description of the rifle to which it is adapted in Chapter IV.

Where known, the penetration of the various cartridges with different bullets is given. This standard penetration test is made with $\frac{7}{8}$ -inch pine boards set up 15 feet from the muzzle of the rifle. It is really no indication of the power of the cartridge. In many cases the penetration with a given bullet is less at high than at low velocity as the bullet is more upset and deformed at high velocity.

The groove diameters of the standard barrels for the various cartridges are approximate only. For example, the standard diameter

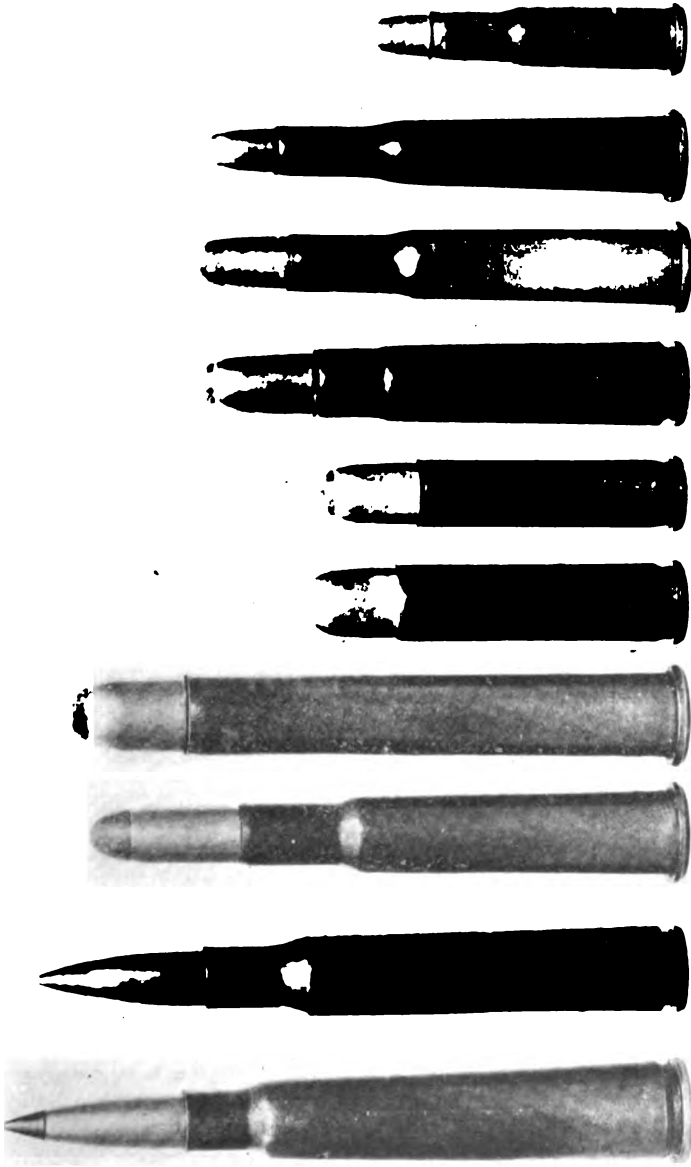

Fig. 70

Some of the more common American cartridges. From left to right:

- .230 Ross, 142-grain, copper-tube, expanding bullet.
- .30-caliber, Model 1906, U. S. service cartridge.
- .30-40 (Krag), 220-grain, soft-point bullet.
- .405 Winchester, 300-grain, soft-point bullet.
- .35 Winchester self-loading.
- .30-30 Winchester center fire.
- .25-20 Marlin high power.
- .25-20 W. C. F. (repeater).

of the barrel for the .30-40 cartridge is given as .308 inch, measuring from the bottom of one groove to the bottom of the opposite groove. Actually this diameter varies in different rifles from .308 to .310 inch, but .308 is the standard size.

Wherever reloading is recommended, the chamber pressure of the various charges of powder is given. All these charges have been tried and found safe. I have myself tried over half of them, and at the same time have given accuracy tests to the various loads. But one caution should be given. *During the last year (1916) the quality of the brass produced for cartridge shells has been very inferior. Many of these shells will not stand reloading with pressures over 48,000 pounds per square inch. Wherever the pressure goes over this it would be well to cut down the powder charge about two grains, unless one knows that his shells are made of good brass such as the ammunition companies were able to obtain prior to 1916.*

In a majority of cases under each cartridge have been given the "Standard pressure." Standard pressure is the mean pressure which should approximately be given by that cartridge when the standard velocity is developed. Each rifle manufacturer sets this standard for himself, taking into consideration the margin of safety in arms of his manufacture. It will be noticed that in the case of certain special loads giving superior ballistic results this standard pressure has been slightly exceeded. In every case where loads have been recommended which exceed this standard pressure, particular pains have been taken to ascertain that the rifles in which they are recommended have plenty of margin of safety to stand this excess pressure.

An examination of the data here given will make it perfectly plain that in many cases the companies loading ammunition have not modernized their ammunition to the extent that is permissible with modern powders. There are several reasons for this: the natural reluctance to change from existing standards, the fact that a change in the ballistics of a certain load makes necessary a change in the sighting of the rifle, and the fact that in many cases an increase in the velocity gained by the adoption of modern progressive burning powders entails a larger charge of powder and a consequent increase in the expense of loading the ammunition. As opposed to these reasons it may be cited that such a change means increased ballistic efficiency in the cartridge and rifle, an increase in the accuracy life of the rifle, and in many cases greater ease in cleaning and less trouble with corrosion. These advantages are such that the rifleman himself

would seem to have a right to demand that the loading companies turn from their old powders of ten years ago to more modern powders and bullets, and this view-point is having its effect, as it is known that in a number of cases the standards have recently been changed.

.22 SHORT, RIM-FIRE CARTRIDGE

This is the lightest cartridge adapted to any American rifle. As a matter of fact there are two smaller cartridges of this caliber known



.22-short, rim-fire cartridge

as BB and CB caps, but these cannot be recommended, and are hardly worth mentioning. They are not accurate or reliable, and their use will ruin any rifle. The .22-short, rim-fire cartridge is loaded with about 4 grains of black powder, or its equivalent in other powders, and a lead bullet of 29 or 30 grains. It is designed for short range use in .22-caliber rifles. It is a most excellent cartridge for gallery use up to 25 yards in rifles that are chambered and rifled especially for it alone. Such rifles should have a twist of rifling of from one turn in 20 inches to one turn in 24 inches. This cartridge has been used for years by the most expert Schuetzen riflemen for their 25-yard gallery competitions, and has proved excellent for the purpose and very accurate. Given a first-class rifle and fresh ammunition, and one can rely on every shot striking a ten-cent piece at 25 yards, provided always he does his part correctly. The best ammunition for accuracy at the present time is that loaded with either Lesmok or semi-smokeless powder. This cartridge is recommended entirely for gallery shooting up to 25 yards. Its accurate range is about 50 yards. It should never be used for game shooting as it is entirely too light for anything but rats and English sparrows. A hollow-point bullet is furnished by some factories, but the velocity is so small that in the majority of cases the bullet does not expand as intended.

Almost always the choice of this cartridge is a mistake, as, except for 25 yard (and shorter) gallery shooting where expense and noise are a consideration, it is completely outranked in every way by the .22-long rifle cartridge. Certain cautions should be observed regarding this cartridge. Its continued use in a rifle chambered for the .22-long, or .22-long rifle cartridge will result in ruining the chamber of the rifle through burning it out just forward of the mouth of the shell. Under

no circumstances should this cartridge ever be used loaded with smokeless powder as the barrel is sure to become ruined in a short time. There is no known way of cleaning a .22-caliber rifle barrel to prevent ruination through pitting and rusting when .22-caliber smokeless ammunition is used in it. The smokeless ammunition is more expensive and less accurate than when loaded with black, Lesmok, or semi-smokeless powders. When shooting with this cartridge the barrel should be cleaned about every 50 rounds to get the best results, and to prevent leading the bore.

The muzzle velocity of this cartridge is about 900 feet per second, and its muzzle energy about 54 foot pounds, but these figures will differ slightly with the various manufacturers and also with various powders used. The standard pressure is 9000 to 10,000 pounds per square inch.

.22-LONG RIFLE, RIM-FIRE CARTRIDGE

In many respects this is one of the most remarkable cartridges ever produced. It is essentially a target cartridge, and it is remarkably accurate up to 100 yards, at that range not being excelled by any other



.22-long rifle, rim-fire cartridge

cartridge. It is adapted to a great variety of rifles and is extremely popular among all classes of riflemen. It is used almost exclusively by all the small-bore rifle clubs in this country and England. Many different small repeating rifles are made to handle it by all our arms companies, but it is only in the heavy, single-shot, target rifle that the cartridge has a chance to show what it is really capable of doing. The following are the average ballistics of this cartridge, although the product of various factories differs quite a little:

Weight of bullet	40 grains
Weight of black-powder charge	5 grains
Muzzle velocity	970 feet per second
Muzzle energy	83 foot pounds
Penetration in $\frac{3}{8}$ -inch pine boards.....	5½ boards
Standard pressure, pounds per square inch.....	10,000 to 12,000

The cartridge is furnished by the various companies loaded with black, Lesmok, semi-smokeless, and smokeless powders; the latter, however, should never be used, as it is less accurate, less powerful, higher trajectory, more expensive, and there is no way known of

cleaning the bore when smokeless cartridges are used which will prevent ultimate pitting and ruin of the barrel. The cartridge can be furnished in both solid and hollow-pointed bullets, the latter increasing the killing power quite a little. But even with hollow-point bullets the killing power of this cartridge is so small that its use on any game larger than rats and English sparrows will result in so much crippled and wounded game, with all its attending suffering, that I wish to recommend strongly that this cartridge never be used for hunting, although I am aware that it is at the present time a very popular grouse and squirrel cartridge, and many times it has even killed large game when the bullet has happened to hit an instantly vital part. I myself, when a boy, killed a deer with this cartridge. But in recent years I have seen so many squirrels and grouse fairly hit with it, only to struggle off to die in misery that I have entirely given it up as a squirrel and grouse cartridge in favor of the .25-caliber rim-fire cartridge.

In the year 1910 I conducted a large number of accuracy tests with this cartridge on a 100-yard, indoor armory range. The rifle used was a Winchester single shot with a heavy No. 3 barrel, set triggers, and a Winchester type A-5 telescope sight. The rifle weighed ten pounds and had a most accurate barrel. The experiments developed many things already known about this cartridge, and also many things that were at that time not generally known, although they have since been found out by others in the course of the shooting of this cartridge by thousands of expert riflemen in the .22-caliber indoor and short-range rifle clubs and leagues. These tests showed that cartridges loaded with Lesmok and semi-smokeless powder were much more accurate than those loaded with black or smokeless. That freshly loaded ammunition bought directly from the factory was much more accurate on an average than that purchased in stores in small towns where it had been on the dealer's shelf for quite a long time; that various lots of ammunition showed considerable difference in accuracy, although 95 per cent. of it was remarkably good; that the ammunition shot better on some days than on others, being considerably influenced in this respect by the amount of moisture in the air; that the particular rifle did its best shooting with a certain make of ammunition, and that it also shot relatively poorly with a certain make that did best in another rifle, also of Winchester manufacture.

The following tabulation of tests fired with three makes of cartridges will be of interest to the reader. The figures are the average of 10 groups of 10 shots each fired from rest with the rifle described

above, the measurement being from center to center of shot holes farthest apart.

Cartridge	25 yards, inches	50 yards, inches	100 yards, inches
Remington—U. M. C.			
Lesmok75	1.95	3.96
Winchester			
Lesmok90	2.00	4.03
Peters			
Semi-smokeless60	1.30	2.61

It should be distinctly understood that this table does not in any way indicate the relative accuracy of the various makes, but only shows the average results of a rather extensive test with one rifle and three different lots of ammunition. In another rifle the relative accuracy of the three makes of cartridges might be exactly reversed. In fact, many tests of this cartridge have shown positively that all makes of this ammunition loaded with these two powders are remarkably accurate and reliable, but that every rifle has one particular make with which it seems to do better than with the others, and this particular make cannot be determined without a test similar to the above.

One test was conducted to get a line on the trajectory of the various cartridges, or, more particularly, on the drop of the bullet. The rifle was sighted in on the 25-yard target, and when shooting nicely was turned on one at 50 yards, the 50-yard group being fired with the sight adjustment correct for 25 yards. This gave a drop of the bullet below the point of aim at 50 yards as follows:

U. S. Cartridge Co., Lesmok50 inch
Peters, crimped, Semi-smokeless	1.25 inches
Peters, uncrimped, Semi-smokeless75 inch
Winchester, Lesmok87 inch
Remington—U. M. C. Lesmok25 inch

No attempt is made to explain these differences. They are simply the actual results of the test. In another extensive test the average elevation required for 50 and 100 yards above the 25-yard elevation was as follows:

Cartridge	Minutes of angle of elevation required above the 25 yard elevation for	
	50 yards	100 yards
Peters, Semi-smokeless	1½	8¾
Remington—U. M. C. Lesmok	½	6½
Winchester Lesmok	2½	10¾

It was decidedly noticeable that in that year, 1910-11, the Reming-

ton-U. M. C. Lesmok cartridges were striking the target butts much harder than any of the other makes tried, which included almost all makes on the market.

The angles of elevation given by the Remington-U. M. C. Co., for their .22-long rifle Lesmok cartridge are as follows:

25 yards	4 minutes	125 yards	23 minutes
50 yards	9 minutes	150 yards	28 minutes
75 yards	13.5 minutes	175 yards	33.5 minutes
100 yards	18 minutes	200 yards	39 minutes

The following experiments were conducted by Mr. C. S. Landis, and I have every confidence in them. The rifle was a Stevens Ideal with heavy barrel and a telescope sight set on top of the barrel. The ammunition used was Peters, loaded with semi-smokeless powder. The rifle was carefully targeted at 25 yards, the 25-yard group of course striking center. With this sighting the rifle was then fired at targets placed at 45 and 60 yards. The 45-yard group measured 1½ inches and its center of impact was just half an inch below the point of aim. The 60-yard group measured 1 inch, and was just 2 inches low. Both these groups contained 24 shots. The sights were then set for 50 yards and the experiments repeated at 60, 45, and 25 yards. At 60 yards the rifle shot 1½ inches low, at 45 yards ¼ inch high, and at 25 yards .6 inch high.

All of the above tests are given to show the average work of this cartridge, the average trajectory, etc. In scanning them, it will be at once apparent how necessary it is, even on a .22-caliber rifle, to have sights which are readily adjustable in order to have the rifle shoot where it is held. The rifleman may sight his rifle in with one lot of ammunition, and a month later go to the same store and purchase identically the same make of ammunition but from another lot; that is, made on a different machine at the factory from the first lot he purchased, and probably also loaded with a different shipment of powder from the powder factory. This lot may shoot as much as 1½ inches away from the point of impact of the first lot at 25 yards, and how is one ever to be sure of his sighting with the sights almost invariably furnished with the small .22-caliber repeating rifles? The small repeating rifle should shoot almost as accurately as the heavy .22-caliber target rifle, for the bores are identical, and the factory spends just as much time and labor on rifling one of the repeating rifles as it does the target rifle. But the light weight of the rifle, the coarser trigger pull, and the crude sights make it impossible for the rifleman to do

his part as well with the light repeater as with the heavy single shot.

In order to show just what this cartridge is capable of when things are working just right, I record below the results of 40 consecutive shots fired from my Winchester single-shot rifle equipped with telescope sight. Ten shots each were fired at 25, 50, 75, and 100 yards, indoors, rest, without cleaning, with Peters uncrimped ammunition loaded with semi-smokeless powder.

Range, yards	Elevation, minutes	Wind-gauge	Size of group, inches
25	4	0	.47
50	6	0	1.05
75	9	0	1.16
100	13	0	1.49

.22 WINCHESTER RIM-FIRE CARTRIDGE



This is an inside lubricated, rim-fire cartridge adapted to the Winchester repeating rifle Model 1890, the Winchester single shot rifle, the Stevens Ideal single shot rifle, and the Remington-U. M. C. repeating rifle Model 12CS. It is loaded with 7 grains of black powder and a 45-grain bullet, both solid and hollow-point bullets being furnished. It can also be had loaded with Lesmok and smokeless powders, the latter powder not being recommended as cartridges loaded with it are more expensive, less accurate, and when they are used there is no known way of keeping the bore of the rifle from pitting and rust. Best results will be obtained from cartridges loaded with Lesmok powder. The following is data for the regular factory cartridge as manufactured by the Winchester Arms Company:

Muzzle velocity	1,107 feet per second
Velocity at 100 yards	915 feet per second
Muzzle energy	122 foot pounds
Energy at 100 yards	84 foot pounds
100 yards trajectory height at 50 yards	4.39 inches
200 yards trajectory, height at 100 yards	20.82 inches
Penetration, $\frac{1}{8}$ -inch pine boards	7 boards
Standard pressure, lbs. per sq. in.	13,000 to 15,000

The .22 Remington Special is identically the same cartridge but manufactured by the Remington-U. M. C. Co., for use in Remington rifles.

This cartridge is not in the same class as the .22-long rifle as far as accuracy is concerned, nevertheless it is quite accurate up to 150

yards, and is a very much better killing cartridge for small game such as grouse and squirrels. Its trajectory is such that it is difficult to hit game with it at ranges over 75 yards unless the range is very carefully estimated and allowance made for the fall of the bullet, either by sight adjustment or by holding over. At 25 yards in a good rifle it should place all its shots in a circle $\frac{3}{8}$ inch in diameter, and at 50 yards into a 2-inch circle. This makes it rather unsuitable for very accurate shooting, like squirrel shooting, except at short ranges. It is, however, a better hunting cartridge than any of the outside lubricated, .22-caliber cartridges, as the grease is not rubbed off the bullets when the ammunition is carried loose in the pocket, and the action of repeating rifles handling it is not dirtied up with the exposed lubricant. It is also a much better cartridge for use in the extreme cold of northern countries where an outside lubricated cartridge is sometimes apt to freeze fast in the chamber. This cartridge requires a barrel specially chambered and rifled for it, and cannot be used in barrels adapted to the other .22-caliber, rim-fire cartridges.

.22 SAVAGE HIGH-POWER CARTRIDGE



Adapted to the Savage Model 1899 repeating rifle. This is a modern cartridge of high intensity and very high velocity. The following is the data for the factory cartridge and rifle:

Muzzle velocity	2,800 feet per second
Velocity at 100 yards	2,453 feet per second
Velocity at 200 yards	2,131 feet per second
Velocity at 300 yards	1,833 feet per second
Muzzle energy	1,190 foot pounds
Energy at 100 yards	911 foot pounds
Energy at 200 yards	687 foot pounds
Energy at 300 yards	510 foot pounds
100 yards trajectory, height at 50 yards62 inch
200 yards trajectory, height at 100 yards	2.75 inches
300 yards trajectory, height at 150 yards	8.00 inches
Penetration, soft point bullet, $\frac{1}{8}$ -inch boards	12 boards
Penetration, full patch bullet, $\frac{1}{8}$ -inch boards	52 boards
Powder charge, Du Pont No. 21	24.3 grains
Bullet, pointed, soft point, copper jacket	70 grains
Diameter of bullet228 inch
Groove diameter of bore of rifle, about226 inch
Depth of grooves003 inch
Twist of rifling, one turn in	12 inches
Chamber pressure, pounds per square inch	48,000 to 50,000

The following powder charges may also be used with good results in this cartridge: with the regular 70-grain jacketed bullet:

Powder	Grains weight	Velocity, feet per second	Pressure, foot pounds
Du Pont military rifle No. 20	27.5	2,750	48,000
Du Pont military rifle No. 21	24.3	2,800	48,000
Du Pont improved military rifle No. 15..	27.5	2,700	48,900
Du Pont improved military rifle No. 18..	27.9	2,800
Du Pont improved military rifle No. 16..	27.0	2,803	46,920
Du Pont improved military rifle No. 16..	27.8	2,850

All of these powder charges should be carefully weighed on scales, and not measured, except the Du Pont military rifle powder No. 21, which can be measured quite accurately on the Ideal universal powder measure No. 5. The next to last charge of 27 grains of No. 16 powder is recommended as giving low pressure and very clean shooting.

For a short range load I have had very good results from the Ideal bullet No. 228367 with gas check and 12 grains weight of Du Pont gallery rifle powder No. 75. This makes a very nice and accurate load. The Ideal Manufacturing Co. recommend that this bullet be used with 17 grains of Du Pont military rifle powder No. 21. This I have not tried.

The Savage rifle for this cartridge has been christened by Mr. E. C. Crossman as the Imp. It is well named. I do not regard it as a reliable cartridge. Some rifles shoot this cartridge fairly well, and others give groups of about 12 inches at 200 yards. It is an effective cartridge for deer and similar game at ranges under 200 yards, as the velocity gives an explosive effect to the bullet which is very destructive to tissue. The bullet, however, being very light, is prone to fly to pieces on large bones and fail to penetrate into the vitals, and the proportions of failures are a little too numerous to make it a reliable cartridge on large game. It has not the required accuracy for small game shooting. The rifle to which the cartridge is adapted has a 20-inch, very light barrel, weighs only 6½ pounds, and the construction of the action is such that it is not possible to get a very good trigger pull with it. It is a hard rifle to shoot accurately on account of these features, and this adds to the general unreliability of the cartridge and rifle. In all points this cartridge, and rifle, are so far outclassed by the newer Savage cartridge, the .250-3000, that I look for it to become obsolete in several years. It is really a freak, and because it was such it obtained quite a popularity at one time due to its very light weight, small size, small caliber, and very high velocity. As its

manufacturers say, "It was the most talked of rifle in America."

.25 STEVENS RIM-FIRE CARTRIDGE

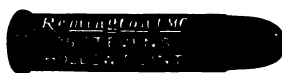

This cartridge is adapted to Stevens Favorite and Ideal single shot rifles, Winchester and Remington-U. M. C. single shot rifles, and to the Marlin repeating rifle Model 27. It is loaded with 10 to 11 grains of black powder, and an inside lubricated lead bullet of 65 to 67 grains weight. It is also furnished by some cartridge companies loaded with Lesmok powder and with hollow-point bullets of 5 grains less weight than the solid bullets. It is not at present loaded with smokeless powder. The following is the data for the regular factory cartridge as loaded by the Remington-U. M. C. Co.:

Muzzle velocity	1,180 feet per second
Muzzle energy	208 foot pounds
100 yards trajectory, height at 50 yards	5.12 inches
Penetration, $\frac{1}{8}$ -inch pine boards	7 boards

This cartridge is strongly recommended as a small game cartridge up to 50 yards. It makes a most excellent grouse cartridge for sportsmen to use on their trips after large game as it kills the birds neatly without ruining meat. It is hardly accurate enough for squirrel shooting except at ranges not over 25 yards. It is advertised as a very accurate cartridge, but I have failed to find it so. It does not hold its elevation well, and when tested on a chronograph a great variation in velocity is found. As a result the shots string up and down on the target. An average target shot at rest by an expert rifleman at 25 yards in a first-class rifle will measure about 1.25 inches high by .75 inch wide.

I found that the killing power of this cartridge, and its effect as regards the fitness of the game for the table or taxidermist, were so excellent that I went to considerable time and expense to obtain satisfactory results with it. First I procured a Winchester single shot rifle with heavy No. 3 barrel chambered and rifled for this cartridge, the barrel having the regular 17-inch twist. This barrel was tried on the Mann "V" rest with concentric action and showed the following average for a large number of shots:

25 yards	1.43 inches	100 yards	3.07 inches
50 yards	2.57 inches	200 yards	6.00 inches

The barrel was then cut off at the breech and chambered by Mr. A. O. Neidner with one of his perfect, tight chambers and tried again. The groups were about a half-inch smaller at 25 yards, but both before and after chambering this rifle gave many key-holes. A .25-caliber barrel with a 14-inch twist was then procured and chambered for this cartridge by Neidner, as it was thought that this would improve the shooting by stopping the tendency to key-hole. This barrel was also tested on the Mann "V" rest on covered range and gave the following groups:

25 yards	50 yards	100 yards
.75 inches	2.25* inches	2.67 inches
.95 inches	1.94 inches	2.73 inches
1.07 inches	1.97 inches	2.13 inches
.78 inches	1.84 inches	3.12 inches
1.10 inches	1.95 inches	2.87 inches
1.06 inches	1.43 inches	2.76 inches
1.33 inches	2.35 inches	3.14 inches
1.30 inches	1.98 inches	
.78 inches	2.54 inches	
	1.42 inches	
Av. 1.013 inches	1.96 inches	Av. 2.917 inches
	1.76 inches	
	Av. 1.966 inches	

All the groups contained ten consecutive shots and were fired with United States Cartridge Co. ammunition, shells uncrimped, and Lesmok powder except that marked * which was fired with Remington-U. M. C. black-powder cartridges. All ammunition was purchased fresh from the factory.

.25-20 WINCHESTER CENTER-FIRE CARTRIDGE
(For Repeating Rifles)



This cartridge is adapted to the Winchester repeating rifle, Model 1892, and to Marlin repeating rifles, Model 1894 and Model 27. This cartridge was brought out to fill a demand for a .25-20 repeating rifle. By taking the .32-20 shell and necking it down to .25-caliber the manufacturers were able to produce a cartridge having almost identical ballistics to the .25-20 single-shot cartridge, and to use it in actions adapted to the .32-20 cartridge, thus obviating the necessity of bringing out an entirely new rifle and action to fill the demand.

The factory cartridge loaded with black powder contains 17 grains of powder and an 86-grain bullet. Smokeless cartridges are also provided by the factories loaded with sufficient Sharpshooter smokeless powder to give the same, or a few feet more, velocity as black powder. There is also a high velocity cartridge furnished, which has a little more Sharpshooter powder than the ordinary smokeless cartridge, and gives a few hundred feet per second higher velocity. The following are the ballistics of the factory cartridges:

BLACK AND LOW POWER SMOKELESS CARTRIDGE

Muzzle velocity	1,376 feet per second
Velocity at 100 yards	1,108 feet per second
Muzzle energy	362 foot pounds
Energy at 100 yards	235 foot pounds
100 yards trajectory, height at 50 yards.....	2.88 inches
200 yards trajectory, height at 100 yards.....	14.08 inches
300 yards trajectory, height at 150 yards.....	41.03 inches
Penetration, lead bullet, $\frac{3}{8}$ -inch boards	9 boards
Penetration S. P. bullet, $\frac{3}{8}$ -inch boards.....	8 boards
Penetration, F. P. bullet, $\frac{3}{8}$ -inch boards.....	11 boards
Standard pressure, pounds per square inch.....	20,000 to 22,000

HIGH VELOCITY CARTRIDGE

Muzzle velocity	1,732 feet per second
Velocity at 100 yards	1,371 feet per second
Muzzle energy	573 foot pounds
Energy at 100 yards	359 foot pounds
100 yards trajectory, height at 50 yards.....	1.82 inches
200 yards trajectory, height at 100 yards.....	9.37 inches
300 yards trajectory, height at 150 yards.....	26.22 inches
Penetration, soft point bullet, $\frac{3}{8}$ -inch boards....	10 boards
Penetration, full patch bullet, $\frac{3}{8}$ -inch boards.....	20 boards
Standard pressure, pounds per square inch.....	27,500 to 30,000

In the winter of 1911 I conducted a very thorough accuracy test with a Winchester Model 1892 rifle chambered for this cartridge. The rifle had an ordinary barrel of the steel regularly adapted to black powder. The tests were all made at 50 yards from a very good muzzle and elbow rest. Ten groups of ten shots each were fired with each kind of ammunition, and the average is shown in the table on following page, the groups being measured from center to center of shot holes farthest apart.

As a result of these tests the Winchester low pressure smokeless cartridge was chosen for use in this rifle, and I used it for a summer's shooting in Maine for small game. Subsequent trials seemed to show that this cartridge was even more accurate than in the initial tests. The combination proved fine for small game shooting, and this was one of the most satisfactory little rifles for a time that I have ever owned.

Ammunition	Size of groups, inches	Remarks
Winchester, black powder, lead bullet..	2.20	Bad caking at breech.
Winchester, low pressure smokeless, soft point bullet	1.57	Very accurate, 1 group measured .8 inches.
Winchester, high velocity, soft point bullet	2.35	Clean.
Remington—U. M. C. black powder, lead bullet	4.20	Bad caking at breech.
Remington—U. M. C. low pressure smokeless soft point bullet.....	1.90	Clean.
Remington—U. M. C. high velocity, soft point bullet	2.20	Clean.
Peters, semi-smokeless, lead bullet.....	3.55	No caking, less fouling than black powder.

As I was a little afraid of the Sharpshooter powder, which I knew to be very hard on barrels, the greatest care was taken in cleaning this rifle. The barrel was always cleaned in the following manner. First, it was thoroughly scrubbed with the ammonia swabbing solution (see chapter on The Cleaning and Care of the Rifle), and then thoroughly dried. It was then cleaned again with oil, and finally liberally oiled with Marble's Nitro-solvent Oil. It was never left over night without cleaning, and it was always cleaned again on the following day in the same manner. Despite this care, after about 300 rounds of this ammunition had been fired from it the barrel began to show pitting, and the pitting progressed so fast that after about 500 rounds had been fired the accuracy began to deteriorate. After about 600 rounds it would no longer hold a 2½ inch group at 50 yards, and the rifle was disposed of.

Pitting in a rifle barrel is practically always caused by the acid fouling of the primer, where the rifle is properly cleaned. It was afterwards found that when small charges of smokeless powder are used the fouling of the powder does not dilute the fouling of the primer to any extent. In this case the primer fouling is so acid that it starts to eat the bore right away as soon as deposited. The fouling of most smokeless powders is a little alkaline, but Sharpshooter powder seems to be less alkaline than others, therefore when a small charge of Sharpshooter powder is used in a shell we have an extremely acid primer fouling. This was the cause of the deterioration of this barrel. It may be said that while at first rifles adapted to this cartridge will prove most satisfactory when used with the low-pressure smokeless ammunition as loaded by the factories, and particularly by the Winchester Company, yet this cartridge and rifles adapted to it cannot be recommended because of the ultimate ruination of the bore when factory ammunition is used.

It is possible for the rifleman to load excellent ammunition for this rifle and cartridge which will not have this bad effect on the bore. If the rifle has a barrel of nickel steel, or special smokeless steel, these steels being furnished on special order, then very excellent results, as good accuracy as with the low-pressure, factory, smokeless cartridge, can be obtained by using a smokeless primer and as much Schuetzen smokeless powder as can be gotten in the shell without crushing it when the bullet is seated. Use the Winchester soft-point, jacketed bullet. If, however, the rifle has the ordinary black-powder, steel barrel a black-powder primer must be used, and as this primer will not satisfactorily ignite a straight smokeless charge it will be necessary to prime with black powder. Therefore the following load is recommended for rifles having black-powder steel barrels: Remington-U. M. C. primers Nos. 1 or 1½. Two grains bulk of F. F. G. or F. F. F. G. black powder placed in the base of the shell, and on top of it about 6 grains weight (15 grains black powder measure) of Schuetzen (Du Pont) smokeless powder. A Winchester 86-grain, soft-point, jacketed bullet. This charge will also give excellent results, and will not ruin the barrel.

It cannot be impressed too strongly on riflemen that accuracy is absolutely essential in any rifle intended for small game shooting. Draw a life-size outline of small game and see how small the vital parts are. Even at the short range of 50 yards a very accurate cartridge is necessary to make a sure shot into the vitals. An inaccurate rifle will give many misses on this kind of game, and will also give many hits not in vital parts, and thus cause much suffering and wounded game, and therefore be entirely unsuitable for small-game shooting. For this reason, and also because of its bad effect on the bore, the high velocity cartridge cannot be recommended. It is not as accurate, has very little more power than the ordinary cartridge, and the difference in trajectory is so slight as to make little practical difference. In fact, on account of the rather poor accuracy of the high-velocity cartridge, a good shot can make sure shots on small game at a longer range with the low-pressure smokeless cartridge. The low-pressure cartridge is sufficiently powerful for all small game. In fact it will tear grouse and squirrels up pretty badly. It will even kill deer very neatly if it strikes a vital spot, but it is most decidedly not recommended for a deer rifle. This cartridge is a most excellent one for turkeys, foxes, woodchucks, coyotes, western ground squirrels, and similar game at ranges up to 75 or 100 yards, and when a repeat-

ing rifle is desired. Beyond 100 yards this rifle is not satisfactory for small game as the trajectory is too high.

.25-20 SINGLE-SHOT CARTRIDGE



Mr. J. F. Rabboth, a member of the Massachusetts Rifle Association, deserves credit for originating the .25-caliber rifle. He wrote the first article advocating such a rifle in the April 18, 1889, issue of "Shooting and Fishing," but for three years prior to this he had been experimenting with a .25-caliber rifle made especially to order for him by the Remington Arms Company. The shell was made by necking down the .32-caliber shell for the Wesson rifle. The charge was 32 grains of Hazard's ducking powder and a 76-grain lead bullet. The 200-yard trajectory was but 7 inches high at 100 yards. It was experiments with this rifle that led up to the placing on the market of the .25-20 single-shot cartridge in the summer of 1889. The Maynard rifle was the first arm placed on the market chambered for this cartridge, followed several weeks later by the old Stevens tip-up rifle. The cartridge was first made by the Union Metallic Cartridge Company.

The factory black-powder cartridge is furnished loaded with 20 grains of powder and an 86-grain lead bullet. Smokeless powder cartridges are also furnished loaded with Sharpshooter powder and either lead or jacketed bullets. The following are the ballistics of this cartridge as loaded by the various factories:

Muzzle velocity	1,412 feet per second
Velocity at 100 yards	1,133 feet per second
Muzzle energy	381 foot pounds
Energy at 100 yards	245 foot pounds
100 yard trajectory, height at 50 yards	2.74 inches
200 yards trajectory, height at 100 yards	13.52 inches
300 yards trajectory, height at 150 yards	35.80 inches
Standard pressure, pounds per square inch	21,000 to 23,000
Penetration, lead bullet, 7/8-inch boards	9 boards
Penetration, S. P. bullet, 7/8-inch boards	8 boards
Penetration, F. P. bullet, 7/8-inch boards	11 boards

The black and smokeless cartridges as loaded by the ammunition factories will give about the same results in this rifle as similar cartridges in rifles chambered for the .25-20 Winchester center-fire car-

tridge. The smokeless factory cartridge also has the same ruining effect on barrels as the similar cartridge for the .25-20 W. C. F. Neither of these cartridges are therefore recommended, and the rifleman should load his own ammunition, purchasing new primed shells in the first place.

Black-powder cartridges, or cartridges loaded with semi-smokeless powder, do fairly well when a 77-grain bullet is used. The 14-inch twist with which most of the rifles adapted to this cartridge are cut is a little too slow for the 86-grain bullet at the velocity given with the full charge of black-powder, and many bullets keyhole. The lead bullet should be loaded projecting a little farther from the shell than that of the factory cartridge, which is possible with a single-shot rifle. But the best accuracy is obtained with a smokeless charge and a jacketed bullet.

The .25-20 single shot is one of my favorite rifles, and I conducted a great many experiments with various rifles of this caliber running over a number of years from 1899 to 1915. It is not necessary to tabulate all these here, suffice to say that by far the best results were obtained by the following load: Winchester shells; Winchester No. 1W primers; 8.5 grains weight of Du Pont Schuetzen powder; the 87-grain Savage soft-point spitzer bullet made for the .250-3000 Savage rifle loaded as far out of the shell as could be and the cartridge still be easily loaded into the chamber without force. The regular .25-caliber, 86-grain, soft-point bullet was also tried and did very well, but did not give quite as satisfactory results as regards accuracy as the Savage bullet. This load with the Savage bullet gave groups averaging 1.25 inches at 50 yards, and groups as small as .68 inches have been fired with it at that range. The rifle used was a Winchester single-shot rifle with a 27-inch, No. 3 round, nickel-steel barrel, set triggers, and Winchester type A5 telescope sight. With a black-powder, steel barrel I would recommend using the Remington-U. M. C. No. 1 or No. 1½ primer, a priming charge of 2 grains of F. F. F. G. black powder, and a proportionately smaller charge of Schuetzen powder as in the case of the .25-20 Winchester center-fire cartridge in order to prevent the barrel becoming pitted.

A trajectory test of this special load was made in this rifle as follows: Five shots at 50 yards gave a group measuring .71 inches, and the load struck center. Ten shots were then fired at 65 yards with the same sight adjustment, resulting in a group measuring 2.00 inches, the center of impact of which was 1.17 inches below the point of aim. Ten

shots were then fired at 25 yards with the same 50-yard sight adjustment, resulting in a group measuring .73 inches, which was .25 inches below the point of aim. The rifle was then fired at 65 yards and the sight correctly adjusted for that range. With this sight adjustment it was found to shoot $\frac{1}{2}$ inch high at 50 yards and exact center at 25 yards. It was therefore decided that the correct range for which to have the sights adjusted for small game shooting was 65 yards. It should be remembered that in this test a telescope sight, mounted high above the barrel, was used, and that the line of sight was about $1\frac{3}{4}$ inches above the axis of the bore.

Bore sighting. When correctly adjusted telescope is aligned on the center of the bull's-eye at 50 yards, a sight on the target through the bore strikes the target approximately 4 inches above the bull's-eye.

This special load has now been used in this Winchester rifle for four years with most excellent results, and the bore, which has always been carefully cleaned not later than the evening of the day on which it was fired, is still in perfect condition. With this load this rifle is a most excellent small game and short-range target rifle. It kills all kinds of small game neatly, but is too powerful for grouse, as it ruins much of the meat, and if grey squirrels are to be fit for the table they must be hit in the head, an easy matter with this outfit up to about 70 yards.

At present this cartridge is only adapted to the Winchester single-shot rifle, and the Stevens Ideal rifle.

The diameter of all .25-caliber bullets is .257 inch, and all rifles of this caliber that I have measured have practically this groove diameter also.

.25-21 STEVENS CARTRIDGE; .25-25 STEVENS CARTRIDGE

These cartridges are identical except that the latter has a little longer shell to enable it to hold 4 grains more powder. They are both adapted to the Stevens Ideal single-shot rifle. Quite a number of Winchester single-shot rifles have also been rechambered for the .25-21 cartridge by private parties. The shells are straight inside, and a straight taper outside. They were very popular in the days of black powder and were brought out in answer to the demand for a straight .25-caliber shell, as it has always been thought that black powder shot better from a straight shell than from a bottle-necked one. The .25-20 single-shot cartridge has a slightly bottle-necked shell.

The factory ammunition of both these cartridges gives slightly greater velocity than the factory .25-20 single-shot cartridge, but the difference

is so small as to make practically no difference in the power and trajectory. I have never been able to obtain any satisfactory results from these cartridges with factory loads, which are furnished only with black powder and lead bullet. Either of these cartridges may be reloaded, using practically the same loads as in the case of the .25-20 single-shot cartridge, increasing the powder charges slightly on account of the increased capacity of the shells, and very satisfactory results obtained. The .25-25 shell may be loaded with a charge of Du Pont military rifle powder No. 21, about 18.5 grains weight, so as to leave a small air space, and an 86-grain jacketed bullet, and quite a high velocity obtained, probably almost 2000 feet per second. In all cases where smokeless powder is used the primer should be a Remington-U. M. C. No. 1 or 1½, and the shell should be primed with 2 grains bulk of F. F. F. G. black powder in order to obviate the pitting of the barrel from the undiluted primer fouling. All the barrels for the Stevens Ideal rifles, to which these cartridges are adapted, are furnished only with the ordinary black powder steel. Observe the same principles in loading as in the case of the .25-20 single-shot cartridge.

.25-35 WINCHESTER CENTER-FIRE CARTRIDGE



This cartridge is adapted to the Winchester repeating rifle, Model 1894, the Winchester single-shot rifle, and the Savage repeating rifle, Model 1899. The following is the data for the factory cartridge:

Muzzle velocity	1,978 feet per second
Velocity at 100 yards	1,680 feet per second
Velocity at 200 yards	1,420 feet per second
Velocity at 300 yards	1,218 feet per second
Muzzle energy	1,017 foot pounds
Energy at 100 yards	734 foot pounds
Energy at 200 yards	516 foot pounds
Energy at 300 yards	386 foot pounds
100 yard trajectory, height at 50 yards.....	1.32 inches
200 yards trajectory, height at 100 yards.....	6.21 inches
300 yards trajectory, height at 150 yards.....	16.61 inches
Penetration, soft point, ⅝-inch boards.....	11 boards
Penetration, full patched, ⅝-inch boards.....	36 boards
Weight of bullet	117 grains
Diameter of bullet257 inch
Average groove diameter of barrels257 inch
Powder charge, Hercules lightning powder, about	18 grains
Twist of rifling, one turn in	8 inches
Standard pressure, pounds per square inch.....	32,000 to 34,000

The following powder charges may also be used with either the regular 117-grain soft-point or full-jacketed bullet, or the 86-grain jacketed bullet of the .25-20 cartridge, the velocities and pressures being given for the former bullet:

Powder	Weight grains	Velocity, feet per second	Pressure, pounds per square inch
Du Pont improved military rifle No. 16....	22.3	1984	26,000
Du Pont improved military rifle No. 16....	25.5	2300	37,000
Du Pont improved military rifle No. 18....	23.5	2000	35,000
Du Pont military rifle powder No. 20.....	22.5	2042	37,200
Du Pont military rifle powder No. 21.....	20.1	1975	34,000

All the above powder charges, except the last, should be weighed and not measured. The last will measure very evenly in the Ideal Universal Powder Measure No. 5. Use Remington-U. M. C. No. 9 or U. S. Cartridge Co., No. 8 primers. If using the 86-grain bullet, seat only about $\frac{1}{8}$ inch of the base of the bullet in the shell.

For reduced load use the 86-grain, jacketed bullet for the .25-20 cartridge, and about 10 grains weight of Du Pont gallery rifle powder No. 75. This makes a very nice load of about the power of the .25-20. Ideal gas-check bullet No. 257306 can also be used with about 17 grains weight of Du Pont military rifle powder No. 21 as a midrange load, but is not quite as accurate as the jacketed bullet. There are a number of other Ideal bullets which can be used in this cartridge, for which see the "Ideal Handbook," but my experience has been that the 86-grain, jacketed bullet is very much more accurate, the twist of rifling in .25-35 rifles being a little too rapid (8 inches) for alloy bullets.

This is a very popular cartridge, and deservedly so. It is extremely accurate, perhaps the most accurate of all our sporting cartridges. It will give 5 to 6-inch groups right along at 200 yards in a good rifle. It is also a most excellent all-around cartridge where game larger than deer is not liable to be encountered. It makes a very nice little deer rifle, particularly when loaded with 25.5 grains of Du Pont improved military rifle powder No. 16, the velocity in this case being about 2300 feet per second. The factory cartridge loaded with the full-patched bullet makes a fine turkey rifle and also for varmints such as coyote, fox, etc., particularly when it is desired not to ruin the meat or the skin. The 101-grain, sharp-point, full-patched bullet for the .25 Remington auto-cartridge can also be used with the same powder charge as for the 117-grain bullet, and fine target results obtained up to 500 yards at least, or this bullet can be used with about 10 grains of Du Pont gallery rifle powder No. 75 and a very nice light charge obtained

with which grouse and squirrels can be shot without ruining them for the table. If a Winchester single-shot rifle with No. 3 barrel be used, all these cartridges and loads will shoot with practically the same sight adjustment at 50 yards, making an ideal combination. I consider this the very best caliber for South American jungle hunting, and for the Eastern United States, where the largest game is deer, it is just the cartridge.

I had a Winchester single-shot rifle with 14-inch twist chambered for this cartridge by Mr. A. O. Neidner. The chamber was cut quite tight, and it was intended to use only the 86-grain bullet. After experimenting very extensively with it I found the most accurate charge to be 22 grains weight of Du Pont military rifle powder No. 20, and the Winchester 86-grain, soft-point jacketed bullet. With this load the rifle gave groups at 100 yards averaging 1.77 inches. The rifle had a telescope sight mounted on top of the barrel, and with this sight the sight adjustment was exactly the same for 50 and 100 yards, making a most excellent combination for small game shooting at ranges beyond the capacity of the .25-20 cartridge. I have used this rifle with fine success, even on the small South American deer. It is an excellent woodchuck and turkey rifle, but is a little too powerful for squirrels and grouse. Strange to say, it does not shoot well with the 86-grain bullet if the velocity is reduced to that of the .25-20 cartridge, many of the bullets key-holing. I have never been able to work out a good reduced load for it due to this reason. This rifle has now been fired about 3000 rounds, and the barrel shows no signs of erosion or wear.

.25-36 MARLIN CARTRIDGE



This cartridge is very similar to the .25-35 Winchester cartridge, but the shell is a little different, and the two cartridges are not interchangeable. Despite its name, the shell holds about two grains less powder than the .25-35, and is slightly less powerful. It is adapted only to the Marlin repeating rifle, Model of 1893. The following are the details of the factory cartridge:

Muzzle velocity	1,855 feet per second
Muzzle energy	893 foot pounds
200 yards trajectory, height at 100 yards.....	7.38 inches
300 yards trajectory, height at 150 yards.....	18.90 inches
Penetration, soft point, 3/8-inch boards.....	11 boards
Penetration, full patched, 3/8-inch boards.....	30 boards

Bullet, flat point, soft point or full patched.....	117 grains
Powder charge, Hercules Lightning, about.....	16.5 grains
Diameter of bullet257 inch
Average diameter of bore, to bottom of grooves..	.257 inch
Twist of rifling, one turn in	9 inches
Standard pressure pounds per square inch	30,000 to 32,000

The bullet differs slightly from that of the .25-35 Winchester cartridge, having a flat point, and being seated a little deeper in the shell. To obtain increased velocity with this cartridge it should be loaded with 25 grains weight of Du Pont improved military rifle powder No. 16 which will give 2250 feet per second velocity, with light chamber pressure. This powder charge should be weighed, not measured. The 86-grain, jacketed bullet can be used for reduced loads with 10 grains weight of Du Pont gallery rifle powder No. 75, and good results obtained. This is a very accurate cartridge up to 200 yards.

.25 REMINGTON AUTO-LOADING CARTRIDGE



This cartridge is very similar to the .25-35 Winchester, and .25-36 Marlin cartridges, except that it has a rimless shell, and contains several grains more powder. It is adapted to the Remington auto-loading rifle, the Remington slide action sporting rifle, and to the Stevens repeating rifle. It is regularly loaded by the factories with two types of bullet, one a 117-grain, blunt-nose, soft- or full-patched bullet, and the other a 101-grain, full-patched, sharp-point bullet. The data for the factory cartridge with these two types of bullets is as follows:

117-GRAIN BULLET

Muzzle velocity	2,127 feet per second
Velocity at 100 yards	1,812 feet per second
Velocity at 200 yards	1,535 feet per second
Velocity at 300 yards	1,303 feet per second
Muzzle energy	1,175 foot pounds
Energy at 100 yards	854 foot pounds
Energy at 200 yards	608 foot pounds
Energy at 300 yards	433 foot pounds
200 yards trajectory, height at 100 yards.....	4.95 inches
300 yards trajectory, height at 150 yards.....	13.77 inches
Penetration, soft point, $\frac{3}{8}$ -inch boards.....	11 boards
Penetration, full patched, $\frac{3}{8}$ -inch boards	44 boards
Powder charge, Hercules Lightning, about.....	22 grains
Diameter of bullet257 inch

Groove diameter of Remington barrel257 inch
 Twist of rifling, one turn in 10 inches
 Standard pressure, pounds per square inch..... 34,000 to 36,000

101-GRAIN POINTED BULLET

Muzzle velocity 2,330 feet per second
 Muzzle energy 1,286 foot pounds
 200 yards trajectory, height at 100 yards..... 3.98 inches
 300 yards trajectory, height at 150 yards 9.10 inches
 Powder charge, Du Pont M. R. P. No. 21, about.. 24.5 grains

The following powder charges may also be used in this cartridge with good results:

POWDER CHARGES FOR 117-GRAIN BULLET

Powder	Grains weight	Muzzle velocity	Pressure, pounds per square inch
Du Pont military rifle powder No. 20.....	25.	1857	32,700
Du Pont military rifle powder No. 21.....	24.2	2100	36,500
Du Pont improved mil. rifle powder No. 18.	20.3	2125	31,100
Du Pont improved mil. rifle powder No. 18.	27.5	2350	39,300
Du Pont improved mil. rifle powder No. 16.	24.6	2118	22,880
Du Pont improved mil. rifle powder No. 16.	30.	2534	37,760

POWDER CHARGES FOR 101-GRAIN POINTED BULLET

Powder	Grains weight	Muzzle velocity	Pressure, pounds per square inch
Du Pont improved mil. rifle powder No. 18.	30.5	2600	38,800
Du Pont improved mil. rifle powder No. 16.	26.	2369	23,080
Du Pont improved mil. rifle powder No. 16.	31.	2753	39,440

With these charges the powder should be weighed and not measured. Notice that some of the charges so greatly improve the ballistics of this cartridge as to put it in the very front rank of modern high-velocity cartridges, and this too with a very low breech pressure. Ideal gas check bullet No. 257325, 110 grains, may be used also with 18 grains of Du Pont military rifle powder No. 21. All the above loads will function the automatic action of this rifle perfectly. A very fine small game load consists of about 10 grains of Du Pont gallery rifle powder No. 75 and the 101-grain, jacketed, pointed bullet. This load will kill grouse and squirrels neatly without injuring the meat for the table, and is quite accurate, but it will not function the auto-loading feature, and it will be necessary to pull the bolt back by hand for each shot.

This cartridge is a most excellent one. There has been a most fortunate combination of powder space, caliber, and weight of bullet. It is an extremely accurate cartridge, even at quite long range, and

a most pleasant cartridge to shoot. For game, it is excellent for everything up to and including deer and black bear. Using the 101-grain, pointed bullet, it makes a splendid rifle for long-range shots at ducks and geese on the water, and is excellent for turkeys and such game. The full charged cartridge with the 117-grain, full-patched bullet is excellent for foxes, coyotes, and other fur bearers, where it is particularly desired not to spoil the skins.

.250-3000 SAVAGE CARTRIDGE



This is a modern cartridge of extremely high velocity adapted to the Savage repeating rifle, Model 1899. The following is the data for the factory cartridge:

Muzzle velocity	3,000 feet per second
Velocity at 100 yards	2,657 feet per second
Velocity at 200 yards	2,340 feet per second
Velocity at 300 yards	2,042 feet per second
Muzzle energy	1,740 foot pounds
Energy at 100 yards	1,375 foot pounds
Energy at 200 yards	1,061 foot pounds
Energy at 300 yards	783 foot pounds
100 yards trajectory height at 50 yards	.4 inch
200 yards trajectory, height at 100 yards	2.5 inches
300 yards trajectory, height at 150 yards	6.3 inches
Bullet, soft point, pointed, copper jacket	87 grains
Diameter of bullet	.257 inch
Groove diameter of bore, average	.257 inch
Powder, Du Pont M. R. P. No. 21, about	30.5 grains
Twist of rifling, one turn in	14 inches
Standard pressure, pounds per square inch	50,000 to 55,000

The following powder charges can also be used in this cartridge with good results:

Powder	Grains weight	Velocity, feet per second	Pressure, pounds per square inch
Du Pont improved mil. rifle powder No. 16.	35.7	2930	31,240
Du Pont improved mil. rifle powder No. 16.	38	3100
Du Pont improved mil. rifle powder No. 16.	40	3361	52,200*
Du Pont improved mil. rifle powder No. 18.	36	3100	46,500
Du Pont improved mil. rifle powder No. 18.	37.5	3180	50,200

* This is the maximum load and should be used only in new rifles or those in excellent condition.

The above powder charges should always be carefully weighed, not measured. Only the regular 87-grain, Savage, pointed bullet should be used.

For reduced loads I would recommend that either Du Pont gallery rifle powder No. 75 or Du Pont sporting rifle powder No. 80 be tried. About 10 grains weight of the former and twelve grains weight of the latter should be about correct. For bullets, use either the regular 87-grain, jacketed bullet, the 86-grain, jacketed bullet for the .25-20 cartridge, or Ideal gas-check bullet No. 257312, the latter sized to about .258 inch. I have obtained excellent results with 10 grains of No. 75 powder and the regular 87-grain, jacketed bullet as detailed below.

I conducted the initial range tests of this cartridge a few months prior to its being placed on the market by the Savage Arms Company. The rifle was a regular stock rifle equipped with a Lyman No. 30½ wind gauge rear sight, and a Lyman gold bead front sight. Rifle shot from my concrete base muzzle and elbow rest. Ten groups of ten shots each were fired at 100 yards for accuracy with Savage factory, full-charged cartridges, which at that time were loaded with 32 grains of Du Pont military rifle powder No. 21, and the 87-grain, soft-point, jacketed, spitzer bullet. The smallest group measured 1.40 inches, the largest 4.12 inches, average 2.96 inches. Measurements were from center to center of shot holes farthest apart. These tests were made with the bullets dry; that is, Mobilubricant was not used. After this firing of 110 rounds during an afternoon no metal fouling at all was visible. Cleaning with the ammonia metal fouling solution gave, of course, the usual blue color, showing that there was a thin, invisible coating of copper fouling. From subsequent shooting it may be said that this cartridge will not metal foul in lumps if the bore is taken care of. There are very few other purely sporting rifles which will show as good accuracy as this, especially in view of the short, light barrel.

Experiments were then undertaken to find a suitable reduced load for use on small game, for the explosive effect of the full charge will literally blow up anything from coyotes down. The regular 87-grain, soft-point bullet was used, and the best charge was found to be 10 grains weight of Du Pont gallery rifle powder No. 75 primed with U. S. C. Co. No. 8 primer, the cartridge being exactly the same as the full-charged, factory cartridge with the exception of the powder charge. This is an excellent load and shoots with all the accuracy of the .22-long rifle cartridge. Ten groups of ten shots each were fired for accuracy at 50 yards from the muzzle and elbow rest, the smallest measuring .95 inch, the largest 1.90 inches, average 1.42 inches. It

was found that for reduced loads it was best to use new shells, or shells that had been fired with reduced loads only. In all lever-action rifles, which do not have the breech bolt supported by lugs at the head, as in the case of bolt actions, there is quite a little elastic spring in the action when fired with cartridges giving pressures around 50,000 pounds per square inch. Shells fired with the full charge are expanded and lengthened, so that if reloaded it is rather difficult to close the bolt. They can be used, but rapid fire with them is out of the question. Shells lengthened in this way can hardly be resized with hand tools. The lengthening is all over and not simply in the neck.

For the high-power load, the Lyman sight on the rifle required setting at 3 points elevation, and zero for wind. The point of impact at 100 yards was one inch above the point of aim. With the reduced load of 10 grains of No. 75 powder the sight was adjusted to 5¼ points elevation, and 1½ points right windage, giving a point of impact at 50 yards ½ inch above the point of aim.

With the No. 30½ Lyman rear sight on the Savage .250-3000 rifle, changing the elevation one point or graduation will move the point of impact 6.15 inches at 100 yards, and a similar change of 1 point in windage will cause a change in point of impact of 2.46 inches at 100 yards.

This is a most excellent cartridge for all game up to, and including, deer, and mountain sheep. With the full-charged factory cartridge it is much too powerful for all small game, but, as will be seen above, it can be loaded by the rifleman to give fine results on all small game. It has an extremely flat trajectory and excellent accuracy, making sure hits at long range an easy matter. For all except the very largest game it is hard to imagine a better arm than the rifle adapted to this cartridge, especially when a light weapon is desired.

.256 NEWTON HIGH-POWER CARTRIDGE



This is a cartridge of very high velocity adapted to the Newton high-power sporting rifle. The manufacturers advertise it loaded with two weights of bullets, 123 grains, and 140 grains. Up to the time of going to press no 140-grain bullets have been placed on the market and the data regarding them is entirely theoretical. The ballistic data

for the cartridge loaded with the 123-grain bullet, as given by the Newton Arms Company, is as follows:

Weight of bullet	123 grains
Muzzle velocity	3,103 feet per second
Velocity at 100 yards	2,891 feet per second
Velocity at 200 yards	2,689 feet per second
Velocity at 300 yards	2,495 feet per second
Muzzle energy	2,632 foot pounds
Energy at 100 yards	2,288 foot pounds
Energy at 200 yards	1,980 foot pounds
Energy at 300 yards	1,709 foot pounds
Diameter of bullet264 inch
Bore diameter of barrel256 inch
Groove diameter of barrel268 inch
Twist of rifling, one turn in	10 inches
Powder charge, Du Pont No. 10 or No. 15.....	46 grains
Powder charge, Du Pont No. 20	42 grains
100 yards trajectory, height at 50 yards.....	.48 inch
200 yards trajectory, height at 100 yards.....	2.08 inches
300 yards trajectory, height at 150 yards.....	5.00 inches
Standard pressure, pounds per square inch.....	55,000 to 58,000

The above velocities were calculated for a 30-inch barrel. The standard 24-inch barrel of the Newton rifle will give about 100 feet per second less velocity than these. The powder charges above are subject to change, the charges having not been definitely decided upon at the time of going to print. In fact the cartridge may still be said to be in the experimental stage to a certain extent, the Great War, and the consequent difficulty in procuring materials, having considerably upset the plans of the Newton Arms Company relative to standardizing on any one product. At present it looks as though this cartridge will ultimately be furnished with a 120-grain bullet. The most recent reliable ballistic data on this cartridge was determined with this 120-grain bullet in a 24-inch barrel as follows:

Powder	Grains weight	Muzzle velocity, feet per second	Pressure, pounds per square inch
Du Pont No. 10.....	48	2,863	54,260
Du Pont No. 13.....	54	2,975	56,200
Du Pont No. 15.....	48.5	2,875	54,060
Du Pont No. 20.....	44	2,757	53,880

The .256 Newton cartridge is a particularly efficient load for large game, especially at long range. The trajectory is exceedingly flat, in fact flatter than any other commercial cartridge, and the expanding, pointed bullet has an explosive effect on animal tissue, making very deadly wounds. It will give good results on all American game.

My own test of this cartridge for accuracy was made in April, 1918, on my experimental range, regular muzzle rest, 100 yards. One group

fired with regular Newton factory ammunition procured in the fall of 1917 gave a measurement of 3.60 inches. Two groups fired under similar conditions with ammunition reloaded with 52.5 grains of Du Pont improved military rifle powder No. 13, and Newton 120-grain bullet, gave measurements of 4.80 and 5.18 inches. All groups were ten shots. Rifle equipped with telescope sight.

.28-30-120 STEVENS CENTER-FIRE CARTRIDGE

This is a low-power, black-powder cartridge adapted to the Stevens Ideal rifle, and to Pope rifles chambered for it.

DATA FOR FACTORY CARTRIDGE

Muzzle velocity	1,405 feet per second
Muzzle energy	526 foot pounds
200 yards trajectory, height at 100 yards.....	32.81 inches
Penetration, lead bullet, $\frac{1}{8}$ -inch pine boards.....	10 boards
Bullet, lead, temper 1 to 32	120 grains
Diameter of bullet285 inch
Powder charge, F. G. black powder.....	30 grains
Primer, Remington — U. M. C. No. 2½ brass.....	...
Twist of rifling, Stevens Ideal, one turn in.....	14 inches

This cartridge was designed by Mr. Charles H. Herrick for the Stevens Company in answer to a demand for a cartridge a little more powerful than the .25-caliber cartridges, but not quite as large as the .32-40, so that it could be used satisfactorily for deer, small game, or 200-yard target shooting. It was designed to cut down some of the expense, etc., of 200-yard target shooting by employing less powder and lead, and at the same time getting a higher velocity. The shell is straight inside, and has just sufficient taper outside to permit of easy extraction. The shell is one of the best made on the market, very much like an everlasting shell, and will stand almost unlimited reloading. The cartridge represents the highest development of the black powder days. It is an odd size, and never became very popular except with rifle cranks. It is an excellent cartridge where a medium caliber, low-power rifle is desired for Eastern game and target shooting. It seems to do its best work with about 30 grains of C. G. semi-smokeless powder, and a 120-grain bullet cast about 1 part of tin to 32 parts of lead. As with all small caliber, black-powder rifles, the rifleman will have to experiment a little with different amounts and lots of powder, and different tempers of bullet in order to get the best results. The regular bullet is the same as the Ideal bullet No. 285221. Ideal bullet No. 285222 is the same except that it has a sharp point, and with it and a slightly smaller powder charge squirrels and grouse can be killed

neatly without mangling. Low-pressure, bulk smokeless powder may also be used in this cartridge, but the bullet should be of a harder temper. If smokeless powder is used it should always be with the regular No. 2½ black powder primer, and a priming charge of about 3 grains of F. F. F. G. black powder, as the smokeless primer is very liable to pit the barrel badly.

.280 ROSS CARTRIDGE



This cartridge is adapted to the Ross Model 10 straight pull sporting rifle, and Ross long-range target rifle. Two types of cartridges are made, one with a light expanding bullet for sporting use, and the other with a long, heavy full jacketed bullet for long range match shooting. The following is the data for the factory sporting cartridge :

Muzzle velocity	3,050 feet per second
Velocity at 100 yards	2,837 feet per second
Velocity at 200 yards	2,635 feet per second
Velocity at 300 yards	2,441 feet per second
Muzzle energy	3,002 foot pounds
Energy at 100 yards	2,710 foot pounds
Energy at 200 yards	2,247 foot pounds
Energy at 300 yards	1,929 foot pounds
200 yard trajectory, height at 100 yards.....	2.20 inches
300 yard trajectory, height at 150 yards.....	5.25 inches
500 yard trajectory, height at 250 yards.....	17.00 inches
Bullet, copper tube expanding, jacketed	143 grains
Diameter of bullet287 inch
Groove diameter of Ross barrel289 inch
Powder charge, Du Pont military rifle No. 10...	58.8 grains
Chamber pressure, pounds per square inch.....	53,500
Twist of rifling, one turn in	8½ inches

This cartridge may also be loaded with the 143-grain bullet and 60 grains weight of Du Pont military rifle powder No. 15 to give a velocity of 3,300 feet per second with a chamber pressure of 55,470 pounds per square inch. This is the maximum charge that should be used. Charges of Du Pont No. 10 and 15 powder should always be weighed on scales, and not measured.

For a reduced load the Ideal Manufacturing Company recommend Ideal gas check bullet No. 291379, cast of No. 1 bullet metal, and sized to .291 inch, with a charge of 30 grains weight of Du Pont military rifle powder No. 21, or 25.2 grains weight of Du Pont sporting rifle powder

No. 80. I have tried this load but did not find it satisfactory. The smallest group fired at 50 yards measured 2.90 inches, and some groups at this distance were as large as 10 inches. Shells that had previously been fired with the regular factory charge were used, and they were exceedingly hard to insert in the chamber and to extract, due to the body of the shell having been expanded to above size. Probably better results could have been secured with new shells, but I was unable to procure these. I would recommend trying this bullet with much lighter charges, say 12½ grains of Du Pont No. 80; or 18 grains of Du Pont No. 18; or 12 grains of Du Pont No. 75.

The factory cartridge is an excellent one ballistically, combining a bullet with a very satisfactory coefficient, and a flat trajectory. Twenty-eight caliber is theoretically the most effective caliber ballistically for a rifle, because a bullet with an extremely effective ballistic coefficient can be used in this caliber without running the recoil up to such an extent that it is not satisfactory for military purposes. But the .280 Ross rifle does not seem to handle this cartridge very well. The accuracy is not good. I have heard of a few rifles which would give 8-inch groups with this cartridge at 200 yards, but I have personally never seen one. Two rifles of this caliber which I have owned would give about 12-inch groups at 200 yards when shot from my concrete base muzzle and elbow rest, or prone with either target sights or a telescope sight. Also Dr. Mann obtained two selected .280 sporting barrels for testing, and upon placing them on his "V" rest found that the best groups that they would give average 7 inches at 100 yards. The trouble seems to be in the size of the neck of the chamber and the groove diameter of the barrel. The bullet is .002 inches smaller than the groove diameter of the barrel, and the chamber is about .004-inch larger at the neck than the neck of the unfired cartridge. As will be seen in the chapter on Accuracy, good shooting cannot be expected from such an arrangement. It seems a pity that a more accurate barrel is not obtainable for this excellent cartridge.

The following are the ballistics of the .280 match cartridge:

DATA FOR FACTORY CARTRIDGE

Muzzle velocity	2,700 feet per second
Muzzle energy	2,834 foot pounds
Weight of bullet	180 grains
Angle of elevation, 100 yards	1.34 minutes
Angle of elevation, 200 yards	3.15 minutes
Angle of elevation 500 yards	9.35 minutes
Angle of elevation 600 yards	12.12 minutes
Angle of elevation, 800 yards	18.27 minutes

Angle of elevation, 1,000 yards	26.28 minutes
Powder charge, Du Pont military rifle No. 10....	53.5 grains
Chamber pressure, pounds per square inch.....	51,070

Despite the discrepancy between the diameters of barrel and bullet, and the large chamber, this cartridge is very accurate in Ross long-range match barrels. It seems to be a case where the inertia of the long, heavy bullet seems to cause prompt upsetting of the bullet to fill the bore without undue deformation of the bullet. The match barrels are throated out a little more than the sporting barrels to receive this cartridge, and this cartridge is so long that it cannot be worked through the magazine, the match rifle being a single shot only, although with practically the same action as the sporting rifle. Ross match rifles for the .280 cartridge are very popular in England for long range match shooting, and have won many matches with very high scores. Wind probably has less effect on the flight of this bullet than is the case with any other cartridge made.

- .30 WINCHESTER CENTER-FIRE CARTRIDGE
- .30 REMINGTON-U. M. C. AUTO-LOADING CARTRIDGE



Commonly known as the .30-30 cartridge. These two cartridges are practically identical, except that one has a rimmed shell, and the other, the .30 Remington, has a rimless shell. The ballistics, powder charge, and bullet are exactly the same. The .30 Winchester cartridge is adapted to a great number of American rifles, the principal being the Winchester Model 1894 repeating rifle. It was this rifle that made the .30-30 cartridge famous and popular. The .30 Remington cartridge is adapted to the Remington auto-loading rifle, the Remington slide-action sporting rifle, and to the Stevens high-power repeating rifle. The ballistic data for the factory cartridge, and for rifles adapted to it is as follows:

Muzzle velocity	2,008 feet per second
Velocity at 100 yards	1,735 feet per second
Velocity at 200 yards	1,493 feet per second
Velocity at 300 yards	1,290 feet per second
Muzzle energy	1,522 foot pounds
Energy at 100 yards	1,136 foot pounds
Energy at 200 yards	850 foot pounds
Energy at 300 yards	629 foot pounds
100 yards trajectory, height at 50 yards.....	1.28 inches
200 yards trajectory, height at 100 yards.....	5.79 inches
300 yards trajectory, height at 150 yards.....	15.23 inches
Penetration, soft point bullet, $\frac{7}{8}$ -inch boards....	11 boards
Penetration, full patch bullet, $\frac{7}{8}$ -inch boards.....	42 boards
Bullet, jacketed, soft point or full patched.....	170 grains*
Diameter of bullet305 inch
Groove diameter of barrel, Winchester, about...	.303 inch
Groove diameter of barrel, Remington, about....	.307 inch
Twist of rifling, one turn in	12 inches
Powder charge, Hercules Lightning, about	26 grains
Standard pressure, pounds per square inch.....	36,000 to 39,000

* The Remington—U. M. C. full-jacketed bullet weighs 160 grains.

The Remington-U. M. C. Co. also makes a cartridge for the .30 Remington rifle loaded with a 157-grain, full-jacketed, pointed bullet for which the following is the data:

Muzzle velocity	2,150 feet per second
Muzzle energy	1,610 foot pounds
200 yards trajectory, height at 100 yards.....	5.25 inches
300 yards trajectory, height at 150 yards.....	14.45 inches

This cartridge can be reloaded with the following powder charges, using the 170-grain, jacketed bullet:

Powder	Grains	Velocity	Pressure
Du Pont military rifle powder No. 21.....	26.4	2000	36,500
Du Pont improved mil. rifle powder No. 18.	29.3	2010	32,900
Du Pont improved mil. rifle powder No. 16.	28.2	2003	26,500
Du Pont improved mil. rifle powder No. 16.	33.	2305	39,120

All the above charges except the first should be weighed, not measured.

The following reduced loads will work well in this cartridge:

Ideal bullet No. 308291 W, cast of Ideal alloy, and sized to .308 inch. 24 grains weight of Du Pont military rifle powder No. 21. No. 9 Remington-U. M. C., or No. 8 U. S. C. Co. primer. This makes a very nice medium load, and it will kill such game as coyotes and foxes neatly without hurting the skins. It is also an economical load for ordinary target practice.

Ideal bullet No. 308241 W, cast of No. 2 Ideal bullet metal, or of 1 part of tin to 10 parts of lead, and sized to .308 inch. Ten grains weight of Du Pont gallery powder No. 75. No. 9 Remington-U. M. C. or No. 8 U. S. C. Co. primer. This is a very good short-range

load, although it will not operate the auto-loading feature of the Remington auto-loading rifle, and that arm will have to be operated by pulling the breech bolt to the rear by hand for each shot. It is quite accurate up to 200 yards. At 100 yards it will keep all shots inside a 4-inch circle. It is a fine short range load, and it will kill small game neatly, grouse being killed without ruining the meat for the table.

The .30-30 is a very popular cartridge, particularly among professional hunters and trappers, and all through Northern Canada. Its popularity is due to several things. The .30-30 was the first high-power rifle to be placed on the American market in any quantity, and it at once became very popular. Both the rifle and ammunition are cheap, and can be procured anywhere. This cartridge is a fine one for game up to, and including, deer and black bear. It is used for all game on this continent, but on the larger game it will seldom kill neatly with one shot, as all cartridges should. It is quite accurate, and at 200 yards the factory cartridge in a good rifle should keep all its shots in about a 7-inch circle. In view of many more modern cartridges having been introduced since this cartridge made its appearance, it cannot be recommended for the sportsman who is about to purchase a new rifle except for use in Northern Canada, particularly in the Hudson Bay and Mackenzie River regions, where the trading posts carry no other kind of high-power rifle ammunition.

The following trajectory table will be of considerable use to the hunter using this and similar cartridges. Figures with the minus sign in front indicate that the shot will strike that amount below the point of aim.

TRAJECTORY TABLE, .30-30 CARTRIDGE
170-grain bullet. Velocity 2,008 feet per second

Height of curve at:	Range sighted to, in yards				
	75	100	150	200	300
25 yards	0.6 inches	0.9 inches	1.6 inches	2.4 inches	
50 yards	0.6 inches	1.2 inches	2.6 inches	4.2 inches	7.7 inches
75 yards	0 inches	1.0 inches	3.0 inches	5.4 inches	
100 yards	-2.2 inches	0 inches	2.8 inches	5.9 inches	12.9 inches
125 yards	-5.0 inches	-2.9 inches	1.8 inches	5.6 inches	
150 yards	-8.7 inches	-6.5 inches	0 inches	4.6 inches	15.2 inches
175 yards		-11.0 inches	-4.5 inches	2.8 inches	
200 yards		-16.5 inches	-9.9 inches	0 inches	14.2 inches
225 yards			-16.3 inches	-6.4 inches	
250 yards			-23.7 inches	-13.8 inches	19.2 inches
300 yards				-31.8 inches	0 inches
350 yards				-55.8 inches	-23.5 inches
400 yards					-53.5 inches

.303 SAVAGE CARTRIDGE



This cartridge is adapted to the Savage repeating rifle Model 1899. It is somewhat like the .30-30 cartridge in appearance and ballistics, although it carries a slightly heavier bullet. The weight of the bullet differs with various ammunition companies producing this cartridge. As loaded by the Savage Arms Company it weighs 180 grains in the full-jacketed, and 190 grains in the soft-nose, variety. With the Winchester make both bullets weigh 190 grains. With Remington-U. M. C. ammunition the soft-nose bullet weighs 195 grains and the full-jacketed bullet 182 grains. The data for the Remington-U. M. C. factory cartridge with 195-grain, soft-point bullet is as follows:

Muzzle velocity	1,952 feet per second
Muzzle energy	1,658 foot pounds
200 yards trajectory, height at 100 yards	5.98 inches
300 yards trajectory, height at 150 yards	15.60 inches
Penetration, $\frac{1}{8}$ -inch pine boards	11 boards
Standard pressure, pounds per square inch	43,000

The bullets average .311 inch in diameter, and the Savage barrels average about .308 inches. The Savage rifles for the .303 Savage cartridge and also for the .30-30 Winchester cartridge are bored and rifled exactly alike; that is, to a standard .308-inch groove measurement, but are of course chambered differently. The Winchester Company uses Hercules W. A., 30-caliber powder in loading their cartridges, the Remington-U. M. C. Company uses Hercules Lightning, while the Savage Arms Company uses about 28.5 grains of Du Pont military rifle powder No. 21. It is not possible to obtain higher velocities than about 2000 feet per second with this cartridge, owing to the fact that the small powder space in the shell, the relatively heavy bullet, and the super size of the bullet run the chamber pressure up too high for the action. Du Pont No. 21 powder is therefore recommended for this cartridge, and should not be used in charges heavier than 29 grains.

An excellent reduced load for this cartridge consists of Ideal bullet No. 308241 S, cast of Ideal No. 2 bullet metal, or 1 part of tin to 10 parts of load, and sized to .311 inch. Ten grains weight of Du Pont gallery rifle powder No. 75. U. S. C. Co. primer No. 8. This load

will keep in a 4-inch circle at 100 yards, and is an excellent load up to 200 yards for target shooting or small game. It will kill grouse neatly without spoiling the meat for the table.

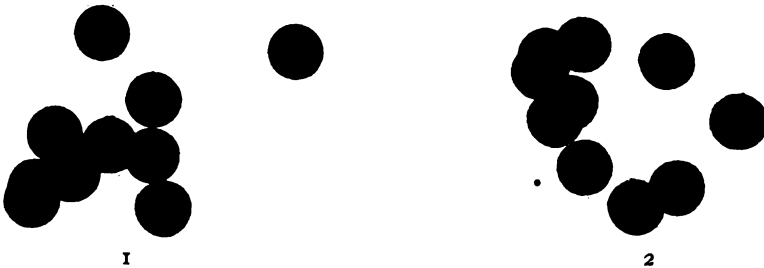

S. S.
Fig. 71

Groups fired with .303 Savage rifle, Lyman sights, muzzle and elbow rest.
No. 1. 10 shots, 50 yards, Remington-U. M. C. ammunition, soft-point bullet.
No. 2. 10 shots, 50 yards, Ideal bullet No. 308241-S, 10 grains of Du Pont gallery rifle powder No. 75. Both groups exact size.

Ideal bullet No. 308291 S can also be used when cast of Ideal No. 1 bullet metal, and sized to .311 inches, with 23 grains weight of Du Pont military rifle powder No. 21. This is quite a powerful load, but the bullet does not expand on animal tissue, so that while it will kill coyotes, foxes, and turkeys neatly it will not blow them to pieces as does the full-charged factory load. It is quite an accurate load up to 500 yards.

The factory cartridge is quite accurate, groups as small as 5 inches have been obtained on my muzzle and elbow rest at 200 yards, and the 200-yard average is about 6 inches. Sometimes, however, the rifle does not seem to hold its elevation well until it has become well heated up by firing, due perhaps to the oversize of the bullet which is about .003 inch larger than the groove diameter of the bore.

This cartridge is very satisfactory for all but the very largest game. It is a considerably better killing cartridge than the .30-30, probably because the heavier bullet is a better bone smasher. Mr. W. G. C. Manson of Lillooet, British Columbia, has used this cartridge for years for large game, and in fact was almost the first man to use it in the field. He told me that when he first received his rifle he took it into the mountains with him on a hunt, and the first box of 20 cartridges accounted for 18 head of large game, including 2 grizzlies. The cartridge is a good one, but is of course considerably outclassed by a number of more modern cartridges.

THE AMERICAN RIFLE

.30-CALIBER U. S. MODEL 1898 CARTRIDGE



This cartridge is also known as the .30 Krag, and the .30-40. It is called the .30 Government cartridge by the Winchester Company. It is adapted to the United States magazine rifle, Model 1898 (Krag), and to the Winchester repeating rifle, Model 1895, and Winchester

TABLE OF REMAINING VELOCITIES AND ENERGIES

Range	Velocity, feet per second	Energy, foot pounds
Muzzle	2,005	1,972
100 yards	1,783	1,553
200 yards	1,590	1,235
300 yards	1,418	985
400 yards	1,265	782
500 yards	1,138	633
600 yards	1,044	533
700 yards	978	467
800 yards	923	416
900 yards	874	373
1,000 yards	831	337

ORDINATES OF TRAJECTORY

Horizontal distance, yards	Height of trajectory above line of sight at:						
	100 yards, feet	200 yards, feet	300 yards, feet	400 yards, feet	500 yards, feet	600 yards, feet	700 yards, feet
100	0						
200	0.46	0					
300	0.99	1.07	0				
400	1.62	2.32	1.88	0			
500	2.36	3.82	4.12	2.98	0		
600	3.23	5.54	6.70	6.43	4.31	0	
700	4.22	7.53	9.69	10.42	9.30	5.99	0

ANGLES OF ELEVATION

Found by experimental firing with Krag.

Range	Angle of elevation	Range	Angle of elevation
100 yards	4.5 minutes	600 yards	41.2 minutes
200 yards	9.7 minutes	700 yards	52.0 minutes
300 yards	15.8 minutes	800 yards	65.8 minutes
400 yards	23.0 minutes	900 yards	80.1 minutes
500 yards	31.6 minutes	1,000 yards	96.0 minutes

Chamber pressure, about	38,000 pounds per square inch
Maximum range at 44 degrees elevation.....	4,066 yards
Groove diameter of barrel, about.....	.308 inch
Diameter of bullet308 inch
Powder charge, Hercules W. A., 30 caliber, about	35 grains
Twist of rifling, one turn in.....	10 inches
Penetration, soft point bullet, $\frac{3}{8}$ -inch boards.....	13 boards
Penetration, full jacketed bullet, $\frac{3}{8}$ -inch boards.	58 boards
Weight of complete cartridge, about.....	439 grains

single-shot rifle. The following are the data for the regular factory and government cartridge, containing the 220-grain, blunt-point, full-jacketed or soft-point bullet:

This cartridge is also loaded by the various ammunition companies with the following loads:

By the Remington-U. M. C. Co.:

Metal cased, pointed bullet weighing 172 grains, giving a velocity of about 2400 feet per second. An excellent long range target load.

Umbrella metal-cased bullet weighing 180 grains, having a muzzle velocity of 2320 feet per second, and a muzzle energy of 2150 foot pounds. This bullet expands well on large game, and the load is an excellent one for all but the very largest game. The velocity is not quite large enough to give that explosive effect seen in the 1906 cartridge, but it will kill well and has a very flat trajectory. The height of the trajectory at 100 yards when the rifle is sighted for 200 yards is only 3.56 inches.

By the Winchester Repeating Arms Co.:

Metal-cased, pointed bullet weighing 180 grains, giving a velocity of about 2300 feet per second. This is an excellent long range target load.

The following mid- and short-range loads can be recommended:

Ideal gas-check bullets Nos. 308284 or 308334, cast of Ideal bullet metal No. 1, and sized to .311 inch. 25.4 grains of Du Pont military rifle powder No. 21. Rem.-U. M. C. Co. No. 9 or U. S. C. Co. No. 8 primers. Muzzle velocity 1725 feet per second. Pressure, 24,540 pounds per square inch.

Ideal bullet No. 308241 S, cast of Ideal bullet metal No. 2, or of 1 part of tin to 10 parts of lead, and sized to .311 inch. Twelve grains weight of Du Pont gallery rifle powder No. 75. Same primers as above. Muzzle velocity, 1400 feet per second. Pressure, 25,000 pounds per square inch.

The 150-grain, full-jacketed service bullet of 150 grains used in the .30-caliber Model 1906 cartridge. Fifteen grains weight of Du Pont gallery rifle powder No. 75. Same primers as above. Muzzle velocity, 1500 feet per second.

The first two loads worked well, and are very accurate in the United States Magazine rifle, caliber .30, Model of 1898, but will not work satisfactorily in the Winchester rifles, as a rule, because the Winchester rifles are chambered tighter than the government arm, and the chamber will not admit of seating shells containing bullets measuring .311 inch without using undue force to seat the cartridge. These bullets do not give accurate results if made much smaller than .311 inch. The last load is a most excellent one for small game shooting. I have used it for many years for this purpose with the best results. It kills all kinds of small game neatly. I have shot otter, beaver, coyotes, monkeys, coati-mundi, agouti, sloth, squirrels, grouse, etc., with it, and it has killed almost instantly, and yet the pelts have not been ruined and the meat has not been all mashed to pieces. With this load, and the full-charged soft-point cartridge the hunter is prepared for all kinds of game.

The .30-40 cartridge can also be loaded with the following bullets and powders to give the results as indicated:

Bullet, grains weight	Powder	Grains weight	Velocity, feet per second	Pressure, pounds per square inch
220	Hercules, W. A., .30-caliber powder...	36.2	2,100	40,000
220	Du Pont improved military rifle No. 15	36.5	1,969
220	Du Pont military rifle No. 20.....	37.5	2,139	44,200 ¹
190	Du Pont military rifle No. 20.....	37.5	2,212	40,600
180	Du Pont military rifle No. 20.....	37.5	2,244	40,200
172	Du Pont military rifle No. 20.....	37.5	2,293	36,900
150	Du Pont military rifle No. 20.....	37.5	2,356	31,300
150	Du Pont military rifle No. 20.....	43.5	2,700	46,000 ¹
220	Du Pont military rifle No. 21.....	33.2	2,025	39,400
220	Du Pont improved military rifle No. 18	36.5	2,005	36,140
220	Du Pont improved military rifle No. 18	39.	2,160	43,300 ¹
190	Du Pont improved military rifle No. 18	40.	2,400	43,800 ¹
172	Du Pont improved military rifle No. 18	42.	2,500	43,340
150	Du Pont improved military rifle No. 18	44.5	2,700	44,600 ¹
150	Du Pont improved military rifle No. 16	45.5	2,830	42,300
170	Du Pont improved military rifle No. 16	43.5	2,636	41,480
190	Du Pont improved military rifle No. 16	41.	2,435	41,400
220	Du Pont improved military rifle No. 16	35.3	2,001	32,140
220	Du Pont improved military rifle No. 16	40.	2,232	41,740

¹ These loads should not be used in the United States magazine rifle, caliber .30, Model 1898 (Krag), but are safe in Winchester rifles that are in first-class condition. Cartridges giving pressures greater than 43,000 pounds per square inch should not be used in the Krag rifle.

The first-mentioned load above was for many years the favorite load for long-range target shooting at the various national matches throughout the country. It gives excellent results at 1000 yards, but it is now outclassed entirely by the pointed bullets of 172, 180 and 200 grains, as the latter, while just as accurate, are very much less influence

by the wind. An excellent load for long range target shooting is the 172-grain Remington-U. M. C., full-jacketed, pointed bullet and 43.5 grains of Du Pont improved military rifle powder No. 16, giving a velocity of 2600 feet per second, with a pressure of only 41,500 pounds per square inch. For big game shooting the best loads are the 220-grain, soft-nose bullet and 40 grains weight of Du Pont No. 16 powder for heavy game like moose and elk, where a bone smashing bullet is desired, and the 180-grain Remington-U. M. C. umbrella bullet (sharp point) and 41.5 grains of Du Pont No. 16 powder, giving a velocity of about 2500 feet per second, with a pressure of about 41,500 pounds for sheep, goats, deer, and all game shot at long range.

I regard the .30-40 cartridge as the most useful and all around successful cartridge ever made for the American sportsman. It is an excellent target cartridge at short, mid, or long range. It is excellent for both large and small game. While, with the ordinary factory loads, it is not quite large enough for the largest game, as it will not stand the test of giving a percentage of even 50 per cent. clean kills with the first shot, yet, with the two big game loads mentioned above, it will almost invariably kill any American game cleanly and quickly. This used to be a very popular big game cartridge among American sportsmen, and it was easily the most popular rifle in the Rocky Mountain country and in Alaska twelve years ago. Of late years it lost its popularity, due to the introduction of rifles of much higher velocity. With the introduction lately of the No. 16 Du Pont powder, which greatly increases the velocity and ballistic efficiency of this cartridge, it should come into its own again. The recoil is light, and moreover the rifleman is not troubled with metal fouling to such a degree as he is with rifles of very high intensity like the .30-caliber Model 1906.

This cartridge makes an excellent all-around one for both large and small game. For an all-around rifle to handle it I would recommend the Winchester Model 1895, particularly if it be made to order with a 24-inch barrel of the same weight and outside dimensions as the .405 barrel regularly made for this rifle. The Krag rifle is not such a good all-around arm as the Winchester, entirely because the reduced loads require a different windage adjustment from the full-charged loads, and when game is in sight it takes entirely too long to change loads, elevation, and windage. With the short, stiff barrel of the Winchester rifle mentioned above there is very little difference between the 200-yard, full-load sight adjustment, and the 50-yard, short-range load adjustment, and practically no difference in the

windage adjustment of the two loads. This makes the change from one load to another very easy and quick.

For many years I have used a Winchester single-shot rifle for this cartridge. It has a 27-inch, No. 3 round barrel, and weighs 9 pounds (see Fig. 8). While it is a single shot, and quite heavy for a hunting rifle, yet it is so thoroughly reliable that I have used it on a number of hunting trips, particularly in British Columbia, California, and the tropics, and always with great success. It shoots the short-range loads at 50 yards with *exactly* the correct sight adjustment for the full-charged load at 100 yards, and as any rifleman can see this is an enormous advantage. If small game is sighted when the rifle is loaded for large game, all that it is necessary to do is to change the cartridge. I have frequently, when testing this rifle, fired many rounds of full-charged cartridges at 100 yards, and small game loads at 50 yards, with exactly the same sight adjustment, aiming at the bottom of the bull's-eye in each case, and kept every shot within a 2-inch circle immediately above the point of aim. Moreover, in ten years this rifle has not changed its elevation an appreciable amount. In fact it is the most reliable rifle I have ever seen or heard of. The only fault that I have to find with it is a fault that it shares in common with all other single-shot rifles: namely, it is difficult to load it quickly when the hands are numb with cold. Despite the opinion of the present generation for users of repeating rifles exclusively, it can be fired and loaded plenty quick enough for any kind of game shooting, except perhaps charging dangerous game.

I append herewith a trajectory table for this cartridge with the regular 220-grain factory load, velocity 2000 feet per second, which will be found useful by sportsmen.

TRAJECTORY TABLE, .30-40 CARTRIDGE
220 grain bullet. Velocity 2000 feet per second

Height of bullet at	Rifle sighted for:					
	50 yards	100 yards	150 yards	200 yards	250 yards	300 yards
	Feet inches	Feet inches	Feet inches	Feet inches	Feet inches	Feet inches
50 yards		1.2	2.5	3.9	5.5	7.
100 yards	-2.4		2.6	5.5	8.6	1 0.
150 yards	-7.6	-3.9		4.3	9.	1 1.5
200 yards	-1 3.6	-11.	-5.6		6.2	1 8.
250 yards	-2 3.	-1 9.	-1 2.7	-7.8		8.
300 yards	-3 6.2	-2 11.	-2 3.5	-1 7.	-7.6	
350 yards	-5 1.7	-4 5.	-3 8.2	-2 9.	-1 6.	-1
400 yards	-7 2.	-6 4.	-5 5.	-4 4.	-2 10.	-2 4.2

The figures with the minus sign (-) in front of them indicate that the bullet strikes *below* the point of aim.

.30-CALIBER, MODEL 1906 CARTRIDGE



This description refers particularly to this cartridge from a sporting or hunting standpoint. For a description of the military cartridge and its ballistics see Chapter IV. The following table gives the ballistics of this cartridge with 150-, 180-, and 220-grain bullets as loaded by the Winchester Repeating Arms Co.:

Weight of bullet	150	180	220 grains.
Muzzle velocity	2,700	2,509	2,204 feet per second.
Velocity at 100 yards	2,465	2,290	1,999 feet per second.
Velocity at 200 yards	2,244		1,812 feet per second.
Velocity at 300 yards	2,039		1,639 feet per second.
Muzzle energy	2,445	2,517	2,375 foot pounds.
Energy at 100 yards	2,034	2,097	1,950 foot pounds.
Energy at 200 yards	1,685		1,602 foot pounds.
Energy at 300 yards	1,392		1,311 foot pounds.
100 yard trajectory, height at 50 yards ..	.68	.76	1.00 inches.
200 yard trajectory, height at 100 yards .	2.95	3.29	4.52 inches.
300 yard trajectory, height at 150 yards .	7.50	8.22	11.40 inches.
Diameter of bullet30825	.308	.308 inch.
Groove diameter of barrel308	.308	.308 inch.
Powder charge, Du Pont No. 20, about	48.6	46.5	43 grains.
Twist of rifling, one turn in	10	10	10 inches.

For penetration see Chapter IV.

This cartridge can also be loaded with the following Du Pont powders, and bullets to give the results indicated:

Powder	Bullet, grains weight	Powder charge, grains weight	Velocity, feet per second	Pressure, pounds per square inch
Du Pont military rifle powder No. 10.....	150	52	2,600	44,640
Du Pont military rifle powder No. 10.....	180	54	2,600	54,820
Du Pont improved military rifle powder No. 15..	150	50	2,700	40,620
Du Pont improved military rifle powder No. 15..	150	54	2,900	51,200

Powder	Bullet, grains weight	Powder charge, grains weight	Velocity, feet per second	Pressure, pounds per square inch
Du Pont improved military rifle powder No. 15..	180	47.6	2,500	46,780
Du Pont improved military rifle powder No. 15..	180	51.5	2,700	56,130
Du Pont improved military rifle powder No. 15..	190	46.6	2,430	46,420
Du Pont improved military rifle powder No. 16..	150	46	2,703	41,940
Du Pont improved military rifle powder No. 16..	150	52.5	3,039	54,640
Du Pont improved military rifle powder No. 16..	220	43	2,206	43,800
Du Pont improved military rifle powder No. 16..	220	45	2,300
Du Pont improved military rifle powder No. 18..	150	51.5	2,925	54,800
Du Pont improved military rifle powder No. 18..	150	48	2,700	44,580
Du Pont improved military rifle powder No. 18..	220	46.5	2,350	50,460
Du Pont military rifle powder No. 20.....	150	48.6	2,686	49,300
Du Pont military rifle powder No. 20.....	172	47.3	2,567	49,090
Du Pont military rifle powder No. 20.....	180	46.6	2,520	49,990
Du Pont military rifle powder No. 20.....	190	45.6	2,424	49,230
Du Pont military rifle powder No. 20.....	195	34.9	1,932	31,100
Du Pont military rifle powder No. 20.....	170	26	2,067	30,660
Du Pont military rifle powder No. 20.....	220	43	2,200
Du Pont military rifle powder No. 21.....	150	46	2,700	50,300
Du Pont military rifle powder No. 21.....	172	42.2	2,460	50,000

All of the above powder charges should be weighed on scales and not measured.

The charges of Du Pont No. 15 powder are particularly recommended for this cartridge. The load of 51.5 grains with 180-grain, pointed bullet makes a most excellent long-range target load, giving to this bullet a very high velocity. This charge is probably less influenced by the wind than any charge in any rifle with the exception of the 180-grain load in the .280 Ross match rifle. The same powder charge with the 180-grain, umbrella-pointed bullet made by the Remington-U. M. C. Co. for the .30-40 cartridge is the most efficient all around load for large game that can be obtained, giving great killing power, fine accuracy, and a very flat trajectory. It will kill with a single shot any game in America. Here we have a load that is effective on Alaska brown bear, and the largest moose, and at the same time has flat enough trajectory, and good enough accuracy for long shots at mountain sheep. I have used this load for a number of years on game with the greatest success, having killed moose and 18-foot crocodiles instantly with it. A large crocodile is the hardest beast to kill instantly that I know of. On deer this load spoils a lot of meat.

For reduced loads the following are recommended:

Ideal bullet No. 308344 with gas check, cast of Ideal bullet metal No. 1, and sized to .311 inch. 25.5 grains weight of Du Pont military rifle powder No. 21. Rem.-U. M. C. No. 9, or U. S. C. Co. No. 8 primer.

This is a fine mid-range load, and shoots accurately up to 500 yards, possibilities having been made at that range on the military target B.

Ideal bullet No. 308241 S, cast of Ideal bullet metal No. 2, or of 1 part of tin to 10 parts of lead, and sized to .311 inch. 10.5 grains weight of Du Pont gallery rifle powder No. 75. Same primers as above. This is a very accurate and inexpensive load for use up to 200 yards. It will keep in an 8-inch bull's-eye on a calm day at that range.

Neither of the above loads will work well in Winchester rifles, as these rifles are usually chambered so tightly that a shell expanded to fit these .311 bullets will not fit the chamber without undue force being used to insert it. Smaller bullets than .311 do not give very good accuracy.

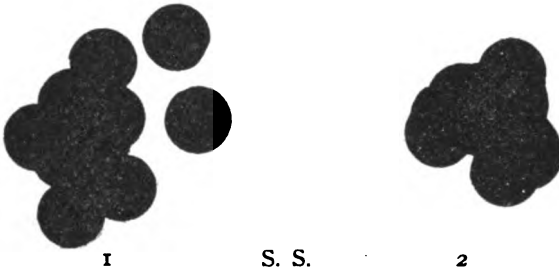

S. S.
Fig. 72

Groups fired with reduced loads in U. S. rifle, Model of 1903. Muzzle and elbow rest, 50 yards. No. 1. 10 shots, Ideal bullet No. 308241, 10 grains Du Pont No. 75 powder, Remington-U. M. C. No. 9 primer, Frankford shells. No. 2. 10 shots, U. S. Government 150-grain, full-jacketed service bullet, 17 grains of Du Pont No. 75 powder. Both groups exact size.

The regular 150-grain, pointed, full-jacketed bullet. Seventeen grains weight of Du Pont gallery rifle powder No. 75. Same primers as above. This is an extremely accurate load up to 300 yards at least. At 50 yards all shots can be kept inside an inch circle. It is the most satisfactory load that I know of for small game, and for use by the sportsman in conjunction with his large game load. The report is light, and the recoil *nil*. It will kill grouse without injuring the meat for the table, and at the same time it has sufficient killing power for all other small game. I have shot monkeys, beaver, otter, coyotes, agouti, and sloth with it, killing instantly in almost all cases, and not spoiling the pelts for the taxidermist. At the same time it will shoot accurately in a rifle which has already been fouled by having the full-charged cartridge fired in it, a thing that no lead or alloy bullet load will do.

In order to give an idea as to the different points of impact and elevations required with various loads in this cartridge, there is given

below the actual elevations required for the different loads in my Springfield rifle which has been remodelled into a sporting arm (regular Springfield barrel) and equipped with Lyman No. 48 rear sight which reads to minutes of angle.

Load	Yards	Elevation	Windgauge
Ideal bullet No. 308241. 10.5 grains Du Pont No. 75	50	21 minutes	3 points right
Ideal bullet No. 308334 25.5 grains Du Pont No. 21	50	16 minutes	3 points right
150 grain pointed full patch. 17 grains Du Pont No. 75	50	16 minutes	2 points right
150 grain United States government service load, 2700 feet per second	100	8 minutes	4 points right
150 grain United States government service load, 2700 feet per second.....	200	11 minutes	4 points right
170 grain Newton S. P. 47.5 grains Du Pont No. 20	100	8 minutes	4 points right
170 grain Newton S. P. 47.5 grains Du Pont No. 20	200	11 minutes	4 points right

In each case the rifle was so sighted that the center of impact of the group came about one inch above where the top of the front sight rested in aiming. The ammunition in the first and second loads seated a little hard, although it was never necessary to pound the bolt handle to close it. The last load was with the 170-grain, pointed, protected-point, copper-jacketed bullets made by the Newton Arms Co.

Colonel Roosevelt used a Springfield sporting rifle with excellent results on antelope and similar game in Africa. The cartridge used was the regular service load with 150-grain, pointed, full-jacketed bullet. He found that the bullet apparently turned over and spun around on striking flesh, and caused a bad wound, killing quickly. Subsequent experiences among a great many sportsmen, however, has shown conclusively that the 150-grain, service bullet is not a satisfactory game bullet. It very often glances and fails to penetrate right through into the vitals in the direction in which it is aimed. Cases have even been known where it has struck a rib on the side of the animal, and, glancing, has entirely encircled the animal just under the skin, coming out on the opposite side, inflicting a very painful but not vital wound.

The most popular big game load at the present time is that loaded with 150-grain, pointed, expanding or umbrella bullet, and having a velocity of 2700 feet per second. This is so principally because it is the only mushroom bullet having the standard velocity of 2700 feet per second that is loaded regularly by the ammunition factories. It does quite good work on all kinds of game, but cannot be regarded as altogether satisfactory. It is a little too light for a bone smasher,

and on the larger game it seems sometimes to explode and fly to pieces before it has penetrated to a vital part. I would hardly call it absolutely reliable on moose and large bear. The special load of Du Pont No. 15 powder, and the 180-grain, Remington-U. M. C. umbrella bullet, mentioned above, is more satisfactory in every respect.

Probably the most satisfactory load regularly produced by the ammunition companies is that loaded with the 172-grain, full-jacketed bullet particularly for long-range target work. This has been used by a number of my friends with very satisfactory results on large game. It is also the load used by Stewart Edward White in Africa. Mr. White has the following to say as regards this load on African game: "SPRINGFIELD: I have fired just 395 cartridges out of this weapon. Of these I have made 307 hits, killed 185 animals, and of those shot at missed 49. The weapon is in good shape and shoots just as well now as it ever did. In fact the last ten animals were killed with thirteen shots, all hits, at 160 (running), 270, 268, 348, 151, 210, 196, 230, 391, and 256 yards, which shows that metal fouling is not bothering much. I keep it down with a Marble brush, clean with boiling water, and use Mobilubricant in the field. With this weapon I killed a very large eland (these beasts weigh from 2500 to 3000 pounds), all my zebra, the greater kudu and roan, wildebeeste, four lions, and all the buck. The pointed bullet is good medicine always. African game of all sizes is notoriously tenacious of life, but of the 185 animals of all sorts killed with this gun, 112 were downed with ONE shot each. It is not heavy enough for lion, rhino, buffalo, hippo, or elephant, however, although it will kill any of them, with the possible exception of buffalo, which is the real tough 'un for punishment, and the rhino except the head shot."

.30-NEWTON HIGH-POWER CARTRIDGE



This is a cartridge of very high velocity adapted to the Newton high-power sporting rifle. It is very similar to the .30-caliber Model 1906 cartridge except that the shell is larger and holds more powder. It can be used with all of the bullets adapted to the 1906 cartridge. It is usually loaded with a 172-grain, copper-jacketed, pointed, soft-point

expanding bullet, and the ballistic data for this load as given by the Newton Arms Co., is as follows:

Muzzle velocity	3,000 feet per second.
Velocity at 100 yards	2,804 feet per second.
Velocity at 200 yards	2,618 feet per second.
Velocity at 300 yards	2,439 feet per second.
Muzzle energy	3,440 foot pounds.
Energy at 100 yards	3,010 foot pounds.
Energy at 200 yards	2,631 foot pounds.
Energy at 300 yards	2,287 foot pounds.
100 yard trajectory, height at 50 yards51 inch.
200 yard trajectory, height at 100 yards	2.22 inches.
300 yard trajectory, height at 150 yards	5.28 inches.
Diameter of bullet308 inch.
Bore diameter of barrel300 inch.
Groove diameter of barrel312 inch.
Twist of rifling, one turn in	10 inches.
Powder charge, Du Pont No. 10 or No. 15	65 grains.

For reduced loads the same jacketed bullets used in the .30-caliber, Model 1906 cartridge will give good results with about 5 grains more powder. If lead alloy bullets are used they should be sized to .313-inch. The use of the various .30-caliber, Ideal gas-check bullets is not recommended for use in this cartridge as the groove diameter of the bore of the rifle is too large for the diameter of the gas check.

The following table gives the actual ballistic results obtained with a .30-caliber Newton rifle:

RIFLE WITH 24-INCH BARREL. NEWTON 172-GRAIN BULLET

Powder	Grains weight	Muzzle velocity, feet per second	Pressure, pounds per square inch
Du Pont No. 10	68.5	2,900	54,820
Du Pont No. 13	79.	3,000	50,740
Du Pont No. 15	67.5	2,900	54,880

In a Newton rifle with 30-inch barrel, 79 grains of Du Pont No. 13 powder and 172-grain Newton bullet gave a velocity of 3225 feet per second with a breech pressure of 50,740 pounds per square inch.

This is an extremely powerful cartridge with high velocity and very flat trajectory. In fact it can be regarded as the most powerful cartridge at present made in America. It is amply powerful enough for any game found in North America, and for all but the very heaviest African game. The recoil is rather heavy for the novice, but in the hunting field will not bother any one accustomed to shooting the .30-caliber, Model 1906 cartridge.

When tested for accuracy on my experimental range, from muzzle

and elbow rest, Newton rifle with Newton peep sight, Newton factory ammunition loaded with Du Pont No. 13 powder and the 172-grain, Newton, copper-jacketed, soft-point bullet, two groups were obtained at 100 yards, measuring 5.38 inches and 9.17 inches. These groups would have been about one inch smaller had a telescope sight been used.

.32-20 WINCHESTER CENTER-FIRE CARTRIDGE



This cartridge is adapted to the Winchester repeating rifles, Models 1873 and 1892, the Winchester single-shot rifle, the Marlin repeating rifles, Models 1894 and 27, and the Stevens Ideal rifle. The data for the factory cartridge as loaded by the Winchester Repeating Arms Co., are as follows:

Muzzle velocity	1,222 feet per second.
Velocity at 100 yards	1,010 feet per second.
Muzzle energy	381 foot pounds.
Energy at 100 yards	261 foot pounds.
100 yard trajectory, height at 50 yards	3.62 inches.
200 yard trajectory, height at 100 yards	16.93 inches.
Penetration, lead bullet, 3/8-inch boards	6.5 boards.
Bullet, 115 grains, pure lead	115 grains.
Diameter of bullet311 inch.
Groove diameter of barrel, about311 inch.
Powder charge, F. F. G. black powder	20 grains.
Standard pressure, pounds per square inch	17,000 to 19,000.

A similar cartridge to the above, with exactly the same ballistics, is also furnished loaded with smokeless powder, and either a lead, soft-point jacketed, or full-jacketed bullet. Also the various ammunition factories supply a high velocity cartridge for which the following are the data:

Muzzle velocity	1,640 feet per second.
Velocity at 100 yards	1,283 feet per second.
Muzzle energy	690 foot pounds.
Energy at 100 yards	420 foot pounds.
100 yard trajectory, height at 50 yards	2.10 inches.
200 yard trajectory, height at 100 yards	10.70 inches.
Penetration, soft point bullet, 3/8-inch boards	7 boards.
Penetration, full patch bullet, 3/8-inch boards	17 boards.
Bullet, 115 grains, soft point or full jacketed	115 grains.
Diameter of bullet311 inch.
Standard pressure, pounds per square inch	25,000 to 27,500.

Of all these cartridges that loaded with smokeless powder and soft-

point, jacketed bullet is probably the most accurate, although very good results can be obtained from freshly loaded black-powder cartridges. The high-velocity cartridge is not quite as accurate as the others, as the velocity is a little too high for the very short bullet. If factory cartridges are to be used it is best to use the black-powder cartridges, as the factory-loaded, smokeless cartridges will very quickly ruin the barrel from pitting. For the reason for this see under the .25-20 cartridge. The black-powder cartridges, and the low pressure smokeless cartridges, are very accurate up to 150 yards, but are hardly suitable for use beyond this range. For reloading use Du Pont Schuetzen, No. 75, or No. 80 powders, and the soft-point or full-jacketed bullets, but always use a black-powder primer and 2 grains bulk of F. F. F. G black powder in the bottom of the shell.

This is a very good little cartridge for general use in the East for small game, and it will even kill deer if one is lucky enough to strike in a vital spot, but it should not be used for a deer gun, as far too large a percentage of this game fired at will simply be wounded. It is also a little too large for squirrels and such game, and has too high a trajectory for small game shooting except at ranges under 50 yards. Within its capabilities it is a very accurate and nice shooting little rifle, and when the black-powder cartridge is used the rifle is very easy to care for. The Winchester Repeating Arms Co., catalogue for January, 1892, page 5, stated in regard to this cartridge: "It is designed for small game at short range, and will be found the most accurate small-bore cartridge on the market." Many years ago the late William Lyman, the inventor of the Lyman sight, had the following to say regarding the .32-20 cartridge: "In the matter of cartridges I am glad to see that sportsmen are appreciating the advantages of shooting a light charge rather than the heavy charges that so many advocated two or three years ago. For large game, of course, a .32-20 W. C. F. cartridge is rather small, but it comes nearer to being an all-around cartridge in my opinion than any other. Up to 200 yards some of the best shooting that I have ever done was with this cartridge. The other morning I took five of these cartridges to my testing box to try an 1892 Model Winchester that my man had just sighted, and the five shots would all have hit a ten-cent piece at 50 yards. An advantage of this light load is that one can shoot 50 or 100 shots without cleaning, which cannot be done with the heavy charges (using black powder)."

.32 WINCHESTER SELF-LOADING CARTRIDGE



This cartridge is adapted to the Winchester self-loading rifle, Model 1905. It is a short, low-power, smokeless cartridge of practically the same ballistics as the .32-40 low-power cartridge. The following are the ballistic data for it:

Muzzle velocity	1,392 feet per second.
Velocity at 100 yards	1,167 feet per second.
Muzzle energy	710 foot pounds.
Energy at 100 yards	499 foot pounds.
100 yard trajectory, height at 50 yards	2.70 inches.
200 yard trajectory, height at 100 yards	12.48 inches.
300 yard trajectory, height at 150 yards	33.25 inches.
Penetration, soft point bullet, $\frac{3}{8}$ -inch boards	10 boards.
Penetration, full patch bullet, $\frac{3}{8}$ -inch boards.....	17 boards.
Bullet, soft point or full jacketed	165 grains.
Diameter of bullet319 inch.
Groove diameter of barrel, about3205 inch.
Standard pressure, pounds per square inch	28,000 to 30,000.

A very satisfactory load for this rifle is Ideal bullet No. 321298, cast of Ideal bullet metal No. 2, or of 1 part of tin to 10 parts of lead, and sized to .321 inch. Seven grains weight of Hercules Sharpshooter powder. Remington-U. M. C. No. 9, or U. S. C. Co. primer No. 8. This load develops slightly less velocity than the regular factory cartridge.

This is a very accurate cartridge up to 300 yards and perhaps farther, but the high trajectory makes it undesirable for game shooting at ranges over 150 yards. It is really not a good game cartridge, as it is not quite powerful enough for large game and too powerful for small game, although it will be found all right for the largest small game such as foxes and coyotes. It is best adapted for rapid-fire target shooting, giving excellent results when the range is known up to 300 yards. Great care should be taken in cleaning rifles firing this cartridge to avoid the pitting of the barrel. The barrel should be scrubbed with stronger ammonia or with Winchester Crystal Cleanser very soon after firing, but not while the rifle is still hot from firing. Then dry the bore, and oil thoroughly. Repeat the cleaning on the following day. It is doubtful if the bore can be fully protected by any method of cleaning, and if much shooting be done a new barrel will probably be necessary every year or two, depending of course on how much the rifle is fired and the care taken of it.

.32-40 CARTRIDGE



This popular cartridge is adapted to a great variety of rifles, almost every manufacturer having made rifles for it at some time. At present the following rifles are being manufactured for it in America: Winchester repeating rifle, Model 1894; Winchester single-shot rifle; Marlin repeating rifle, Model 1893; Savage repeating rifle, Model 1899; Stevens Ideal single-shot rifle. The cartridge is made up in a large number of different loads by the various ammunition companies. The following table gives the data for these loads: Load No. 1 being the black powder and low-pressure smokeless load, a lead bullet being used with the black-powder load and a soft-point or full-patched jacketed bullet with the smokeless load. Load No. 2 is the Winchester high-velocity cartridge loaded with smokeless powder and a soft-point or full-jacketed bullet. Load No. 3 is the Remington-U. M. C. high-power load, using a soft-point or full-jacketed bullet. This last load should only be used in rifles having smokeless steel barrels. Rifles with smokeless steel barrels can be had to order from the Winchester Repeating Arms Company, or can be obtained from regular stock from the Savage and Marlin companies, but are not made by the Stevens Company.

Load No.	1	2	3	
Muzzle velocity	1,427	1,752	2,065	ft. per second.
Velocity at 100 yards	1,194	1,460	1,708	ft. per second.
Velocity at 200 yards	1,055	1,231	1,403	ft. per second.
Velocity at 300 yards	967	1,082	1,177	ft. per second.
Energy at muzzle	747	1,125	1,558	foot pounds.
Energy at 100 yards	523	781	1,072	foot pounds.
Energy at 200 yards	380	561	816	foot pounds.
Energy at 300 yards	330	429	495	foot pounds.
100 yard trajectory, height at 50 yards....	2.45	1.70	1.30	inches.
200 yard trajectory, height at 100 yards...	12.22	8.23	5.47	inches.
300 yard trajectory, height at 150 yards...	31.92	22.08	15.64	inches.
Penetration, lead bullet, $\frac{3}{8}$ -inch pine boards	8.5			boards.
Penetration, soft point bullet, $\frac{1}{8}$ -inch boards	8.5	10	10	boards.
Penetration, full patch bullet, $\frac{1}{8}$ -inch boards	18	30	38	boards.
Diameter of bullets, all kinds319			inch.
Groove diam. of barrels, all makes, about	.3205			inch.
Twist of rifling, all makes, one turn in....	16			inches.
Powder charge, F. G. black powder.....	40			grains.
Standard pressure, pounds per square inch	17,000 to 19,000	30,000 to 32,000	34,000 to 36,000	

The accuracy of these cartridges differ considerably. Satisfactory results cannot be obtained from factory-loaded, black-powder ammunition unless it is quite freshly loaded, and then only fair results. I have found the low-pressure, smokeless cartridge loaded by the Winchester Company to be very accurate at 200 yards when fired from a Winchester single-shot rifle, groups as small as 3.50 inches being obtained at that range. Groups of about 8 inches can be obtained from the Remington-U. M. C. high-power cartridge in a rifle having a smokeless steel barrel.

This cartridge has a great reputation for accuracy. It has been used for years by Schuetzen riflemen for extremely fine work at 200 yards, *but always with bullets seated in the barrel ahead of the shell.* It is not a particularly accurate cartridge when the bullets are seated as deeply in the shell as in the factory ammunition. Very good results can be obtained from lead bullets and black powder, loaded fresh, when the bullets are seated with about one-fourth inch more of the bullet projecting from the shell than is the case with the factory cartridge. A very accurate load for use with either black or semi-smokeless powder is as follows: Ideal bullet No. 321232, cast of 1 part of tin to 32 parts of lead, and sized to .321 inch. Forty-four grains, bulk measure, of King's semi-smokeless F. G. or C. G. powder, or the same amount of F. G. black powder. The bullet seated so that two bands project from the shell. With this load I have obtained 2-inch groups at 100 yards in a Winchester single-shot rifle which had a groove diameter of .3205 inch.

The following loads of smokeless powder can be used in this cartridge, using either the soft-point or full-patched, jacketed bullets:

Kind of powder	Grains weight	Velocity feet per second	Pressure, pounds per square inch
Hercules "sharpshooter"	11	1,450	low
Du Pont smokeless No. 1	17	1,450	low
Du Pont sporting No. 80	13.2	1,450	low
Du Pont military No. 16	21	1,435	11,300
Du Pont military No. 16	25	1,754	21,880
Du Pont military No. 16	30.5	2,200	39,700 ¹
Du Pont military No. 18	23.5	1,430
Du Pont military No. 18	25.3	1,750
Du Pont military No. 18	29	2,100
Du Pont military No. 21	18	1,500	16,000
Du Pont military No. 21	26.5	2,030	43,000

¹ This powder charge should be weighed, not measured. It will be necessary to compress the charge slightly to seat the bullet.

The Ideal Manufacturing Company can furnish a large variety of alloy bullets for this cartridge. Among these may be mentioned bullet No. 31949 of 134-grains weight. This bullet has a very sharp point, and when used with a charge of low-pressure powder it will kill squirrels and grouse neatly without spoiling their meat for the table, a thing that cannot be done with any of the regular bullets, as the flat points tear small game rather badly. Ideal bullet No. 319295 with gas-check may also be used, cast of Ideal bullet metal No. 2, or of 1 part of tin to 10 parts of lead, and sized to .321 inch. With it use 23-grains weight of Du Pont military rifle powder No. 21, giving a velocity of about 1850 feet per second, and very good accuracy.

The Schuetzen riflemen who practice fine target shooting at 200 yards exclusively invariably use very heavy single-shot rifles, and load their bullets ahead of the shell into the rifling by means of a bullet seater (a sort of a plunger working inside a dummy shell which seats the bullet approximately central in the rifling). The shells are filled with powder and a cardboard wad placed on top of the powder to prevent the same spilling. The shell is loaded into the chamber after the bullet has been seated, thus making two operations necessary to load the rifle. Much better accuracy can be secured in this manner than with the bullet seated in the shell, provided the bullet is accurately centered in the bore without deforming it. A great many different bullets and charges of powder have been used in this way by Schuetzen riflemen from time to time, the bullet being almost always a little heavier than the standard 165-grain bullet, running from 180 to 200 grains. The best load that I know of at the present time for regular commercial single-shot barrels that have not been throated is as follows:

Ideal Bullet No. 319289 cast of 1 part of tin to 15 parts of lead, and the two base bands sized so that they are as large as can be seated in the bore with the strong Ideal bullet seater. This size may vary a little with different barrels. For powder charge use the shell full of Du Pont Schuetzen powder, or else about 3 grains of Du Pont No. 1 smokeless powder in the base of the shell, and the balance of the shell filled with King's semi-smokeless powder, F. G. Use a cardboard wad over the powder. It may be necessary to experiment a little with the powder and kind of temper of bullet. The load should give from 4- to 5-inch groups at 200 yards in good barrels.

The best results that can be secured from the regular commercial barrels is with the load designed by Dr. W. G. Hudson, and in order

to use this load it is necessary that the rifling be reamed out a little just in front of the chamber to receive the large bullet. The Ideal Manufacturing Company are prepared to ream out barrels in this manner, but after reaming they can only be used for this one particular bullet. The bullet is the Ideal bullet No. 319273. The two broad base bands of this bullet measure .323 inches, and it can only be seated in barrels that have already been throated, and then requires the strong Ideal bullet seater. The bullet weighs 185 grains, and should be cast of one part of tin to fifteen of lead, and not sized. For powder charge use the shell full of Du Pont Schuetzen powder and use a smokeless primer. This load is good for from 3- to 4-inch groups at 200 yards.

See also the chapter on the Pope Muzzle Loading System.

.32 WINCHESTER SPECIAL CARTRIDGE



This cartridge is adapted to the Winchester repeating rifle, Model 1894, the Winchester single shot rifle, and the Marlin repeating rifle, Model 1893. It was introduced in response to a demand for a smokeless powder cartridge somewhat like the .30-30, which could be reloaded satisfactorily with black powder. The following are the data for the regular factory cartridge:

Muzzle velocity	2,112 feet per second.
Velocity at 100 yards	1,769 feet per second.
Velocity at 200 yards	1,471 feet per second.
Velocity at 300 yards	1,237 feet per second.
Muzzle energy	1,084 foot pounds.
Energy at 100 yards	1,181 foot pounds.
Energy at 200 yards	816 foot pounds.
Energy at 300 yards	578 foot pounds.
100 yard trajectory, height at 50 yards	1.17 inches.
200 yard trajectory, height at 100 yards	5.60 inches.
300 yard trajectory, height at 150 yards	15.26 inches.
Penetration, soft point bullet, $\frac{7}{8}$ -inch boards	12 boards.
Penetration, full patch bullet, $\frac{7}{8}$ -inch boards	45 boards.
Bullets, soft point or full metal patch	170 grains.
Diameter of bullet321 inch.
Groove diameter of barrel, about321 inch.
Powder charge, Hercules "Lightning"	23.5 grains.
Twist of rifling, one turn in	16 inches.
Standard Pressure, pounds per square inch	36,000 to 38,000.

This cartridge can also be loaded with the following charges of powder, using the regular 170-grain, jacketed bullet:

Kind of powder	Grains weight	Velocity, feet per second	Pressure, pounds per square inch
Du Pont military No. 15	32	1,974	26,000
Du Pont military No. 16	30.8	2,120	27,480
Du Pont military No. 16	32.5	2,225
Du Pont military No. 16	33.5	2,395	39,015 ¹
Du Pont military No. 18	33	2,050	34,120
Du Pont military No. 18	34.5	2,275	38,500 ¹
Du Pont military No. 20	31	2,040	35,300
Du Pont military No. 21	29.1	2,090	40,200

¹ These powder charges should be weighed on scales, and not measured.

The following loads with Ideal bullets can also be used:

Ideal gas-check bullet No. 321297, cast of Ideal bullet metal No. 2 and sized to .321 inch. Twenty-four grains weight of Du Pont military rifle powder No. 21. Remington-U. M. C. No. 9 or U. S. C. Co., No. 8 primer. A good load for varmints, etc. Velocity about 1800 feet per second.

Ideal Bullet No. 321232, cast of No. 2 Ideal bullet metal, or of 1 part of tin to 10 parts of lead, and sized to .321 inch. Sixteen grains weight of Du Pont No. 1 smokeless or Du Pont Schuetzen powder, or 15.2 grains weight of Du Pont sporting rifle powder No. 80. Same primers as above. This is a good low-power load, giving about 1450 feet per second velocity.

The .32 Winchester special factory cartridge is a very good load for all but the very largest game. It is a fine deer and black bear cartridge. The slow twist of the rifling makes a barrel of very long life, particularly if the new Du Pont pyro powders are used instead of the old Lightning powder. In fact if these new powders are used there is no reason for using any of the alloy bullets, as the life of the barrel will be practically limitless, and the jacketed bullets always give a little better accuracy. With the 170-grain, soft-point or full-jacketed bullet a very nice light load for short range use is about 14 grains of Du Pont gallery rifle powder No. 75.

.32 REMINGTON-U. M. C. AUTO-LOADING CARTRIDGE

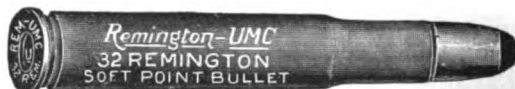

This cartridge is very similar to the .32 Winchester Special, except that it has a rimless shell. It is adapted to the Remington-U. M. C. auto-loading rifle, the Remington-U. M. C. slide action sporting rifle, and the Stevens high-power repeating rifle. The following are the data for the factory cartridge:

Muzzle velocity	2,112 feet per second.
Muzzle energy	1,682 foot pounds.
200 yard trajectory, height at 100 yards	5.31 inches.
300 yard trajectory, height at 150 yards	14.82 inches.
Bullet, soft point or full patch	165 grains.
Diameter of bullet319 inch.
Groove diameter of barrel, about319 inch.
Twist of rifling, one turn in	14 inches.
Powder charge, Du Pont military No. 16	32.3 grains.
Chamber pressure, pounds per square inch	36,000 pounds.

The powder charge used in the factory cartridge gives the best results and highest safe velocity, and other charges are not recommended for the full charge load. Ideal gas check bullet No. 321317 may be used, cast of Ideal bullet metal No. 1, and sized to .321 inch, with 24 grains weight of Du Pont military rifle powder No. 21, with good results, but it is in no way superior to the standard load, except that the bullets are a little cheaper. This cartridge will give about 8-inch groups at 200 yards, and is powerful enough for all but the very largest American big game.

Do not make the mistake of using in this cartridge loads that are recommended for the .32 Winchester special cartridge, as they might prove extremely dangerous. The two cartridges are very different, particularly as regards powder space. The relation of powder space to bullet weight and caliber is such in this Remington cartridge that it is impossible, even with the improved Du Pont powders, even slightly to increase the velocity over the standard.

.33 WINCHESTER CENTER-FIRE CARTRIDGE



A high power, smokeless cartridge adapted to the Winchester Model 1886 repeating rifle, the Winchester single-shot rifle, and the Marlin Repeating rifle.

Bullet, soft point or full metal patched	200 grains.
Bullet, diameter338 inches.
Length of shell	2 ¹ / ₁₀ inches.
Average groove diameter of barrels340 inch.
Powder charge, Hercules W. A. .30 caliber	36 grains.
Muzzle velocity	2,056 feet per second.
Velocity at 100 yards	1,741 feet per second.
Velocity at 200 yards	1,467 feet per second.
Velocity at 300 yards	1,246 feet per second.

THE AMERICAN RIFLE

DATA FOR FACTORY CARTRIDGE

Muzzle energy	1,877	foot pounds.
Energy at 100 yards	1,346	foot pounds.
Energy at 200 yards	960	foot pounds.
Energy at 300 yards	680	foot pounds.
100 yard trajectory, height at 50 yards	1.21	inches.
200 yard trajectory, height at 100 yards	5.78	inches.
300 yard trajectory, height at 150 yards	15.51	inches.
Penetration, soft point, $\frac{3}{8}$ -inch pine boards	13	boards.
Penetration, full jacketed, $\frac{7}{8}$ -inch pine boards	39	boards.
Standard pressure, pounds per square inch	33,000 to 35,000.	

For full trajectory table of this cartridge see under .30-40 Government (Krag) cartridge, the trajectory of these cartridges being so similar up to 300 yards that the table for the .30-40 will suffice for all practical purposes for the .33 W. C. F.

This cartridge owes its popularity to the excellent rifle to which it is adapted, the Winchester Model 1886. It is a very good big game cartridge for all but the very largest game. It is not, however, a very good long range cartridge, as the flat point of the bullet causes its velocity to fall off rapidly, and it has not sufficient accuracy. It is therefore not recommended for distances over 300 yards. At 200 yards accuracy tests show that it will group ten consecutive shots in an 8-inch circle on an average. Groups have been made as small as $5\frac{1}{2}$ inches and as large as 12 inches. It is capable of being specially loaded to give higher velocities, and consequently flatter trajectory, and greater killing power as will be seen below. The recoil is very light, and is hardly more noticeable than that of the .30-30 cartridge.

SPECIAL LOADS

Two hundred-grain, soft-point or full-jacketed bullet, and 41.5 grains weight of Du Pont improved military rifle powder No. 16. Primer U. S. C. Co. No. 8, or Remington-U. M. C. No. 9. Muzzle velocity 2250 feet per second. Muzzle energy 2244 foot pounds. Chamber pressure about 38,000 pounds per square inch. The powder charge should always be weighed and not measured. This is the heaviest load that can be recommended, and the charge should never be exceeded. This load should only be used in new rifles, or those in absolutely perfect condition. While the chamber pressure does not seem particularly high, on account of the taper of the shell the back thrust on the bolt head in rifles using this cartridge is equivalent to that given by very much higher velocities in other rifles using shells with straighter bodies. Subject to these remarks this is an excellent and powerful load.

Two hundred-grain, soft-point or full-jacketed bullet, and 35.4

grains weight of Du Pont military rifle powder No. 21. Same primers as in the first load. Muzzle velocity and energy same as with the factory cartridge. The powder charge will measure very nicely and accurately in the Ideal powder measure No. 5. Where one desires the same results as with the factory cartridge, shells should be re-loaded with this charge as the No. 21 powder gives much less erosion and even better accuracy than the factory charge of Hercules W. A. .30-caliber powder. The accuracy life of the rifle is practically unlimited with this charge, provided the bore be properly cleaned and cared for.

Ideal gas check bullet No. 338320, 199 grains, cast of Ideal bullet metal No. 1 or No. 2, and sized to .340 inch. Bullet lubricated with Ideal banana lubricant. Shells must be first resized at neck and then expanded with a .340 muzzle expander chamber to fit this bullet. Powder charge 31 grains (weight) of Du Pont military rifle powder No. 21. Primers same as with the first special load. Muzzle velocity about 1800 feet per second. A very nice light charge, suitable for coyotes, lynx, etc., where it is specially desired to avoid spoiling the skin. Too powerful for small game.

Ideal bullet No. 338234, 145 grains, cast of Ideal bullet metal No. 2, and sized to .340 inch. Bullet lubricated with Ideal banana lubricant. Shells must first be resized at neck and then expanded with a .340-inch muzzle expander chamber to fit this bullet. Do not crimp. Powder charge 10 grains (weight) of Du Pont gallery rifle powder No. 75, or 12 grains (weight) of Du Pont sporting rifle powder No. 80. Primers same as with first special load. Muzzle velocity about 1300 feet per second. A nice light charge for small game, but on account of the shape of the point of the bullet it will tear grouse and similar game rather badly.

For target practice I would recommend the third load given above, as it is quite accurate and the wear on the rifle is very small.

See also under Winchester repeating rifle, Model 1886.

.35 WINCHESTER SELF-LOADING CARTRIDGE



This cartridge is adapted to the Model 1905 Winchester self-loading rifle. The following are the ballistic data for it:

Muzzle velocity	1,396	feet per second.
Velocity at 100 yards	1,151	feet per second.
Muzzle energy	779	foot pounds.
Energy at 100 yards	530	foot pounds.
100 yard trajectory, height at 50 yards	2.74	inches.
200 yard trajectory, height at 100 yards	13.07	inches.
Penetration, soft point bullet	9	boards.
Penetration, full patch bullet	17	boards.
Bullet, soft point or full patch	180	grains.
Twist of rifling, one turn in	16	inches.
Standard pressure, pounds per square inch	28,000 to 30,000.	

This is a good cartridge for deer and black bear, being very similar in its ballistics and size to the old .38-40 W. C. F. cartridge. It has good accuracy up to 200 yards, but is not particularly good beyond that range. It has a high trajectory and is not suitable for long range work. For white tail deer in thick timber it is a very satisfactory cartridge.

.351 WINCHESTER SELF-LOADING CARTRIDGE



This is a high-power cartridge adapted to the Model 1907 Winchester self-loading rifle. The following are the ballistic data for the factory cartridge:

Muzzle velocity	1,861	feet per second.
Velocity at 100 yards	1,523	feet per second.
Muzzle energy	1,385	foot pounds.
Energy at 100 yards	927	foot pounds.
100 yard trajectory, height at 50 yards	1.55	inches.
200 yard trajectory, height at 100 yards	7.60	inches.
300 yard trajectory, height at 150 yards	21.10	inches.
Penetration, soft point bullet, 1/8-inch pine boards.....	13	boards.
Penetration, full patch bullet, 1/8-inch pine boards.....	26	boards.
Bullet, soft point or full patch	180	grains.
Twist of rifling, one turn in	16	inches.
Standard pressure, pounds per square inch	37,000 to 39,000.	

This is a good cartridge for deer and similar game in close timber. It has plenty of killing power for this game, and the rifle that handles it permits of very rapid fire. It is not suitable for shots much over 200 yards as the trajectory is not flat enough, and the accuracy begins to fall off fast after passing the 200-yard range.

.35 REMINGTON-U. M. C. AUTO-LOADING CARTRIDGE



This is a very popular high-power cartridge adapted to the Remington-U. M. C. auto-loading rifle, the Remington-U. M. C. high-power, slide-action sporting rifle, and the Stevens high-power repeating rifle. It is the most powerful cartridge made for any American auto-loading rifle. As made by the Remington-U. M. C. Co., this cartridge is turned out with two types of bullets, the regular 200-grain, round-point bullet made with either soft point or full patch, and the 170-grain, pointed bullet, made in full patch only. The following are the ballistic data for these two cartridges:

Weight of bullet	200	170	grains.
Muzzle velocity	2,020	2,120	feet per second.
Velocity at 100 yards	1,672	feet per second.
Velocity at 200 yards	1,390	feet per second.
Muzzle energy	1,776	1,695	foot pounds.
Energy at 100 yards	1,240	foot pounds.
Energy at 200 yards	857	foot pounds.
200 yard trajectory, height at 100 yards	5.93	5.32	inches.
300 yard trajectory, height at 150 yards	16.17	14.30	inches.
Penetration, soft point bullet, $\frac{7}{8}$ -inch boards ...	13	boards.
Penetration, full patch bullet, $\frac{7}{8}$ -inch boards ..	32	boards.
Diameter of bullet356	.356	inch.
Groove diameter of barrel, about356	.356	inch.
Twist of rifling, one turn in	16	16	inches.
Powder charge, Hercules "Lightning"	29		grains.
Standard pressure, pounds per square inch	34,000 to 36,000		

The following powder charges may be used with the regular 200-grain, soft-point or full-patch bullet, or they may be increased not to exceed 2 grains and used with the 170-grain pointed bullet:

Kind of powder	Grains weight	Velocity, feet per second	Pressure, pounds per square inch
Du Pont military No. 16	41	2,233	36,660 ¹
Du Pont military No. 16	37	2,000	31,000
Du Pont military No. 18	38.8	2,000	36,000
Du Pont military No. 21	34.3	2,000	41,500

¹ This charge should be weighed on scales and not measured.

Ideal gas-check bullet No. 358315, weighing 202 grains, may also be used, cast of Ideal bullet metal No. 2, or of 1 part of tin to 10 parts of lead, and sized to .358 inch. With it use 30.6 grains of Du Pont military rifle powder No. 21, and the Remington—U. M. C. No. 9 primer. This is an accurate load which is more economical than the others for target practice.

The .35-caliber Remington cartridge is a very satisfactory one for all but the very largest game. It will kill even the large Alaskan bear and moose if struck right, but not always with a single shot. With an auto-loading rifle, however, one is almost sure of getting in a number of shots before the game gets out of sight, and this cartridge has been used in Remington-U. M. C. auto-loading rifles with good success on Alaskan game. It is quite an accurate cartridge, even up to 400 yards, but the trajectory is such that it is not satisfactory for game shooting at ranges much over 200 yards. At 200 yards it can be relied upon to group its shots in about an 8-inch bull's-eye. The twist of the rifling is slow, and the powder charge not excessive, giving to rifles using this cartridge a practically unlimited life, especially when the cartridges are loaded by the rifleman himself with one of the new Du Pont pyro powders instead of the old "Lightning" powder, preferably the Du Pont No. 16 powder which gives very low chamber pressure.

This cartridge gives considerable recoil in the auto-loading rifle, but very light recoil in the slide-action arm.

.35 WINCHESTER CENTER-FIRE CARTRIDGE



This popular cartridge is adapted to the Winchester repeating rifle, Model 1895, and to the Winchester single-shot rifle. The following are the ballistic data for the factory cartridge:

Muzzle velocity	2,200	feet per second.
Velocity at 100 yards	1,923	feet per second.
Velocity at 200 yards	1,672	feet per second.
Velocity at 300 yards	1,448	feet per second.
Muzzle energy	2,687	foot pounds.
Energy at 100 yards	2,053	foot pounds.
Energy at 200 yards	1,550	foot pounds.
Energy at 300 yards	1,175	foot pounds.
100 yard trajectory, height at 50 yards	1.03	inches.

200 yard trajectory, height at 100 yards	4.73 inches.
300 yard trajectory, height at 150 yards	12.24 inches.
Penetration, soft point bullet, 7/8-inch boards	15 boards.
Penetration, full patch bullet, 7/8-inch boards	56 boards.
Bullet, soft point or full patched	250 grains.
Diameter of bullet356 inch.
Groove diameter of barrel, about358 inch.
Twist of rifling, one turn in	12 inches.
Standard pressure, pounds per square inch	39,000 to 41,000.

This cartridge was formerly loaded with Laflin and Rand "35-95" powder, a powder very similar to the Hercules, "W-A. .30 Caliber," which was a nitroglycerine powder, and rather erosive in its effects, but I understand that the change is about to be made to one of the new Du Pont pyro powders which will be a decided improvement.

In reloading with the regular 250-grain, jacketed bullet the best results can be obtained from Du Pont improved military rifle powder No. 16, 45.5 grains weight, giving a velocity of 2189 feet per second, with a chamber pressure of only 32,760 pounds per square inch, and 47.5 grains weight giving a velocity of 2266 feet per second, with a chamber pressure of 37,720 pounds. Forty-six grains of Du Pont military rifle powder No. 20 may also be used, giving about 2200 feet per second, but the chamber pressure will be slightly greater.

The soft-point bullet with full charge is entirely too destructive for small game, even for game as large as foxes and coyotes. For such animals a nice load consists of the regular full-patched bullet and about 36 grains of Du Pont military rifle powder No. 21. Or the Ideal gas-check bullet No. 358318 may be used, cast of Ideal bullet metal No. 1, and sized to .358 inch, with 34 to 36 grains of Du Pont military rifle powder No. 21.

This is an excellent cartridge for all kinds of large game, including Alaska brown bear and moose. It will kill all American big game neatly with one shot if the game is struck anywhere near a vital spot. The recoil is a little heavy to the novice, but one used to shooting will never notice it.

.38 WINCHESTER CENTER-FIRE CARTRIDGE



This is a very old cartridge, having been brought out many years ago for the Winchester repeating rifle, Model 1873. It formerly was

a very popular cartridge, but in recent years has had to give way to more modern cartridges of superior ballistics. Quite a number of rifles are still sold for it, however. At present the following arms are being manufactured for it: Winchester repeating rifles, Models 1873 and 1892; Winchester single-shot rifle; Marlin repeating rifle, Model 1894; Remington-U. M. C. slide-action sporting rifle, Model 14½. Despite its name, this cartridge is really .40 caliber instead of .38 caliber. The ammunition factories load it up with several loads. There is the black-powder load with lead bullet, and the smokeless load of similar ballistics to the black powder load, using soft-point, and full-patched, jacketed bullets. In the last few years the factories have also placed on the market a high velocity load with soft-point or full-jacketed bullets which gives increased velocity and power. The following table gives the ballistics for these loads:

	Black and smokeless	High velocity
Muzzle velocity	1,324	1,776 feet per second
Velocity at 100 yards	1,053	1,367 feet per second
Muzzle energy	701	1,261 foot pounds
Energy at 100 yards	443	747 foot pounds
100 yards trajectory, height at 50 yards	3.19	1.79 inches
200 yards trajectory, height at 100 yards	15.53	9.46 inches
300 yards trajectory, height at 150 yards	41.66	27.33 inches
Penetration, lead bullet, ⅜-inch boards	7.5 boards
Penetration, S. P. bullet, ⅜-inch boards	10	10 boards
Penetration, F. P. bullet, ⅜-inch boards	12	20 boards
Bullet, lead, soft point, or full patch.	180	180 grains
Diameter of bullet400	.400 inch
Twist of rifling, one turn in	36	36 inches
Powder charge, F. F. G. black	38 grains
Standard pressure, pounds per square inch	15,000 to 17,000	21,000 to 23,000

The Winchester Company also make a cartridge of this caliber having a hollow-point bullet weighing 165 grains, which has slightly greater velocity than the black-powder charge, and gives the maximum mushrooming effect on animal tissue.

In reloading this cartridge I would recommend that Du Pont sporting rifle powder No. 80 be used, with either the soft-point or full-jacketed bullet. For the low pressure velocity use 14.9 grains weight, and for the high velocity cartridge use about 17 grains weight. If it is desired to use a lead bullet, either 38 grains bulk of F. F. G. black

powder should be used, or preferably 38 grains bulk of King's semi-smokeless powder, F. G. or F. F. G.

This cartridge is suitable for deer and black bear at ranges up to 200 yards. Beyond that range the trajectory is too high, and the accuracy begins to fall off. The low-pressure smokeless cartridge is the most accurate, being good for about 10-inch groups at 200 yards, or about 3½-inch groups at 100 yards. The high velocity cartridge has greatly superior killing power to the low-power load, but if one is to shoot at rather long range he had better use the low-pressure load as it has plenty of power for deer and black bear up to 200 yards, and is much more accurate, particularly at ranges over 100 yards.

.38-55 CARTRIDGE

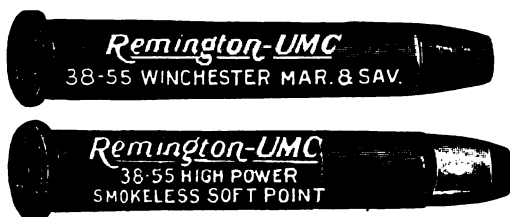

This is a very old cartridge, but it still retains much of its popularity. With the .45-70 cartridge it alone can be said to have successfully withstood the introduction of smokeless powder and high velocity. A great number of different makes of single-shot rifles have been made for it from time to time, and it has always been a favorite cartridge with Schuetzen riflemen. At present the following rifles are being made for it: Winchester repeating rifle, Model 1894; Winchester single-shot rifle; Savage repeating rifle, Model 1899; Marlin repeating rifle, Model 1893; Stevens Ideal single-shot rifle. Three varieties of loads are on the market for this cartridge, the black and low-pressure load, the high-velocity cartridge, and the high-power cartridge. The high-velocity cartridge is loaded only by the Winchester Company, while the high-power cartridge is loaded by the Remington-U. M. C. Co. and some other factories. The following table gives the ballistic data for these various cartridges.

When this cartridge was first made the shell was very thin and had a folded head, and contained 55 grains bulk of black powder. Afterwards the shell was made thicker and stronger to stand reloading, and the powder space decreased, so that the shell as now manufactured will hold but 48 grains bulk of black powder when the bullet is seated

THE AMERICAN RIFLE

BALLISTIC TABLE, .38-55 CARTRIDGES

	Black and low pressure smokeless	High velocity	High power	
Muzzle velocity	1,321	1,593	1,700	feet per second
Velocity at 100 yards	1,131	1,350	1,442	feet per second
Velocity at 200 yards	1,024	1,108	1,238	feet per second
Velocity at 300 yards	944	1,056	1,097	feet per second
Muzzle energy	988	1,437	1,635	foot pounds
Energy at 100 yards	725	1,033	1,173	foot pounds
Energy at 200 yards	580	765	867	foot pounds
Energy at 300 yards	510	637	688	foot pounds
100 yards trajectory, height at 50 yards	2.87	2.01	1.76	inches
200 yards trajectory, height at 100 yards	13.56	9.53	8.19	inches
300 yards trajectory, height at 150 yards	34.42	25.46	20.95	inches
Penetration, lead bullet, 7/8-inch boards	9.5	boards
Penetration, S. P. bullet, 7/8-inch boards	13.5	10	12	boards
Penetration, F. P. bullet, 7/8-inch boards	14.	23	36	boards
Bullet, lead, soft point, or full patch	255	255	255	grains
Diameter of bullet375	.375	.375	inch
Groove diameter of barrel, about378	.378	.378	inch
Twist of rifling, one turn in	18	18	18	inches
Powder charge, F. G. black powder	48	grains
Powder charge, Hercules "Lightning"	grains
Standard pressure, pounds per square inch	18,000 to 20,000	28,000 to 30,000	32,000 to 34,000	

to the standard depth, but the cartridge has retained its old designation. Owing to this lack of powder space a very high velocity cannot be obtained in this cartridge. It is hard to get enough modern smokeless powder into the shell, and the powder does not burn properly.

The following powder charges can be used with good results in the .38-55 cartridge:

With lead bullet:

- 20 grains weight of Du Pont No. 1 smokeless.
- 20 grains weight of Du Pont Schuetzen smokeless.
- 15 grains weight of Du Pont gallery rifle No. 75.

With metal-cased bullet, low power:

- 16.4 grains weight of Du Pont sporting rifle No. 80.

With metal-cased bullet:

- 29.3 grains weight of Du Pont military rifle No. 18. Velocity 1593 feet per second. Pressure 26,000 pounds.
- 23 grains weight of Du Pont military rifle No. 21. Velocity 1390 feet per second. Pressure 19,000 pounds.
- 28 grains weight of Du Pont military rifle No. 21. Velocity 1690 feet per second. Pressure 36,000 pounds.
- 29 grains weight of Du Pont military rifle No. 16. Velocity 1594 feet per second. Pressure 18,300 pounds.
- 32 grains weight of Du Pont military rifle No. 16. Velocity 1700 feet per second.
- 35 grains weight of Du Pont military rifle No. 16. Velocity 1899 feet per second. Pressure 38,760 pounds. This charge should be weighed on scales, and not measured. It will require a little compression of the powder to seat the bullet.

Ideal gas-check bullet No. 375296, cast of Ideal bullet metal No. 2, or of 1 part of tin to 10 parts of lead, and sized to .380 inch may be used with about 25 grains of Du Pont military rifle powder No. 21, and a very satisfactory load secured for target practice.

The .38-55 cartridge is a very satisfactory one for deer and black bear. It has just about the right power to kill deer neatly without ruining a lot of meat, as many high-power cartridges do. It has often been used for larger game, but is a little light. At one time it was very popular among the guides of the State of Maine, and much used on moose, but several years' experience proved that it was not powerful enough for this game, although it did good work on caribou.

This cartridge has long had a big reputation as a very accurate Schuetzen cartridge, the bullet being seated in the bore ahead of the shell, and with the shell full of black or semi-smokeless powder. The bullet used is almost always considerably heavier than the standard bullet for fixed ammunition, sometimes weighing as much as 330 grains. With commercial barrels the best results are now obtained from Ideal bullet No. 375272. The barrel must be throated to take this bullet,

and when so changed cannot be used for other loads, but the results as far as accuracy is concerned makes it fully worth while. This bullet has two large base bands measuring .382 inch, and it cannot be seated in the barrel ahead of the shell unless the bore just in front of the chamber be throated to receive it. The bullet should be cast of 1 part of tin to 15 parts of lead, and not sized. It is to be seated about $\frac{1}{32}$ inch ahead of the shell with the strong Ideal bullet seater. The shell should be filled almost to the top with Du Pont Schuetzen powder, and a blotting-paper wad seated over the powder to retain it in the shell. Use shells that have already been expanded to fit the particular rifle by firing several times in that rifle. In good barrels this load is good for about 3- to $3\frac{1}{2}$ -inch groups at 200 yards, and is much less influenced by the wind than any other Schuetzen loads usually used. The recoil is very light, about like that of the .32-40 black-powder cartridge.

.401 WINCHESTER SELF-LOADING CARTRIDGE



This is a smokeless, high-power cartridge adapted to the Winchester self-loading rifle, Model of 1910. It is regularly loaded with two weights of bullet, 200 and 250 grains. The following are the ballistic data for these two loads:

Weight of bullet	200	250	grains
Muzzle velocity	2,141	1,875	feet per second
Velocity at 100 yards	1,721	1,543	feet per second
Velocity at 200 yards	1,372	1,275	feet per second
Velocity at 300 yards	1,132	1,097	feet per second
Muzzle energy	2,037	1,952	foot pounds
Energy at 100 yards	1,315	1,323	foot pounds
Energy at 200 yards	840	900	foot pounds
Energy at 300 yards	560	675	foot pounds
100 yards trajectory, height at 50 yards....	1.01	1.49	inches
200 yards trajectory, height at 100 yards....	6.47	7.34	inches
300 yards trajectory, height at 150 yards....	17.06	20.36	inches
Penetration, soft point bullet, $\frac{1}{8}$ -inch boards	14	12	boards
Penetration, full patch bullet, $\frac{1}{8}$ -inch boards	34	27	boards
Standard pressure, pounds per square inch.	{ 37,000 to 39,000	{ 37,000 to 39,000	

This is not a particularly accurate cartridge, but it has sufficient accuracy for the purpose for which it was designed, namely for a quick kill at short range. Neither of the loads is accurate enough,

even for large game shooting, at ranges much over 150 yards. It, and the rifle for which it is adapted, are, however, excellent for deer shooting in thick timber and jungle. With the auto-loading rifle a number of shots can be fired very quickly, and the cartridge is a very deadly one, giving quick kills at short range, or else a big blood trail to follow. This cartridge is often compared to the .30-40 (Krag) cartridge to show its power. It has more power at the muzzle than the .30-40 cartridge, but at all other ranges it is decidedly inferior to the latter cartridge as the following table will show. It must be remembered that game is not killed at the muzzle. Also the long, heavy, .30-40 bullet is much more of a bone smasher than the short, large-diameter bullet of the .401 cartridge. Nevertheless the .401 bullet has plenty of destructive force for deer, and plenty of bone smashing power, and is probably a superior bullet for deer at short range to the .30-40-200 grain bullet, as it will cause much more blood to flow, and consequently a plainer trail to follow, if the deer be only wounded.

	.401 A. L.	.30-40	
Muzzle velocity	2,141	2,000	feet per second
Velocity at 100 yards	1,721	1,783	feet per second
Velocity at 200 yards	1,372	1,590	feet per second
Velocity at 300 yards	1,132	1,418	feet per second
Muzzle energy	2,037	1,970	foot pounds
Energy at 100 yards	1,315	1,553	foot pounds
Energy at 200 yards	840	1,235	foot pounds
Energy at 300 yards	560	985	foot pounds

.405 WINCHESTER CENTER-FIRE CARTRIDGE



This is the most powerful cartridge adapted to any American rifle. The only rifle made for it is the Model 1895 Winchester repeater. The following table gives the ballistic data for this cartridge:

Muzzle velocity	2,204	feet per second
Velocity at 100 yards	1,807	feet per second
Velocity at 200 yards	1,623	feet per second
Velocity at 300 yards	1,384	feet per second
Muzzle energy	3,236	foot pounds
Energy at 100 yards	2,399	foot pounds
Energy at 200 yards	1,740	foot pounds
Energy at 300 yards	1,290	foot pounds
100 yards trajectory height at 50 yards.....	1.04	inches
200 yards trajectory, height at 100 yards.....	4.85	inches
300 yards trajectory, height at 150 yards.....	12.82	inches

Penetration, soft point bullet, $\frac{7}{8}$ -inch boards....	13 boards
Penetration, full patch bullet, $\frac{7}{8}$ -inch boards....	48 boards
Bullet, soft point or full patch	300 grains
Diameter of bullet411 inch
Groove diameter of barrel, about.....	.412 inch
Twist of rifling, one turn in.....	14 inches
Powder charge, Hercules "W-A. .30 caliber"....	45 grains
Standard pressure, pounds per square inch.....	43,000 to 45,000

In reloading this cartridge with the regular 300-grain, jacketed bullet the following powder charges of the new pyro powders are recommended as giving less erosion, and consequently a longer accuracy life than the regular charge of W-A. .30-caliber powder which is a nitroglycerine powder:

53.4 grains weight of Du Pont military rifle powder No. 20, muzzle velocity 2173 feet per second. Pressure 43,710 pounds per square inch.
 55 grains weight of Du Pont improved military rifle powder No. 16, muzzle velocity 2192 feet per second. Pressure 41,420 pounds per square inch.

The Ideal Manufacturing Company make bullet No. 412263 weighing 300 grains for this cartridge, and recommend for powder charge 28 grains weight of Du Pont No. 1 smokeless powder. I would also recommend 28 grains of Schuetzen powder. This load will give a velocity of about 1400 feet per second with very low pressure. Quite a different sighting will be required from the full load, and if the rifle is to use the two loads interchangeably it will be necessary to have it equipped with a sight having a large range of adjustment for both elevation and windage like the Lyman Nos. 38 or 41 receiver sights.

This cartridge is the best one on the American market for all kinds of large game. It is powerful enough for any American game, and in fact is unnecessarily powerful for deer and such game. It has been used with excellent results on almost all African game but is a little small for rhino, buffalo, etc., and very much too small for elephant. It is the best moose and bear cartridge made in America, but where one is to do very much long-range shooting, particularly at mountain sheep, the .30 Model 1906 cartridge, loaded as suggested under the description of that cartridge, is advisable.

This cartridge is quite an accurate one. At 200 yards in a good rifle it should group all its shots in a 7-inch circle. The trajectory is quite flat up to 200 yards, but beyond that distance becomes quite curved, owing to the large caliber and the blunt nose of the bullet. It is not a very suitable load for ranges over 200 yards, but inside that range cannot be excelled by any big game cartridge made in America for American rifles. It will kill big game dead with one shot oftener than any cartridge I know of.

The recoil of this cartridge in a Winchester rifle is about the same as that of an ordinary 10-gauge shotgun; a little severe to the novice but not at all troublesome to the seasoned shot.

.44 WINCHESTER CENTER-FIRE CARTRIDGE



This was the first center-fire cartridge produced for a repeating rifle. It was first placed on the market in 1873, being adapted then to the Winchester repeating rifle, Model 1873. This rifle was the first really successful repeating rifle, and immediately become very popular, so much so in fact that it is still being manufactured exactly as it was first put out. This cartridge at once gained an enormous popularity, due almost entirely to the excellent rifle to which it was adapted. The cartridge and rifle are both to a certain extent obsolete today, but are still very popular in out-of-the-way corners of the world, particularly South America. The sportsman of today would hardly choose it for any work, except perhaps should he be called upon to penetrate the South American jungles and wanted an arm of such caliber that he could be assured of getting ammunition for it anywhere.

Ballistically considered, there are two types of ammunition loaded in the .44 W. C. F. shell at the present time; the black-powder type which has low velocity, and which can be obtained loaded either with black or low pressure smokeless; and the other the high-velocity type, being loaded with smokeless powder and given as high a velocity as is safe with the old type of rifles having ordinary steel barrels.

The following are the ballistic data for the black-powder cartridge:

Muzzle velocity	1,300 feet per second
Velocity at 100 yards	1,034 feet per second
Muzzle energy	751 foot pounds
Energy at 100 yards	475 foot pounds
100 yard trajectory, height at 50 yards	3.26 inches
200 yard trajectory, height at 100 yards	15.94 inches.
Weight of bullet	200 grains.
Diameter of bullet424 inch
Powder charge, F. F. G. black	40 grains
Twist of rifling, one turn in	36 inches
Penetration, lead bullet, 7/8-inch pine boards	9 boards
Standard pressure, pounds per square inch	13,000 to 15,000

The high velocity cartridge has the following ballistics:

Muzzle velocity	1,569 feet per second
Velocity at 100 yards	1,202 feet per second

Muzzle energy	1,095 foot pounds
Energy at 100 yards	641 foot pounds
100 yard trajectory, height at 50 yards	2.32 inches
200 yard trajectory, height at 100 yards	12.12 inches
Penetration, soft point bullet, $\frac{7}{8}$ -inch boards.....	10 boards
Standard pressure, pounds per square inch	18,000 to 20,000

At the present time the rifles being manufactured for this cartridge are the Winchester repeating rifle, Model 1873 (for black and low-pressure smokeless only); the Winchester repeating rifle, Model 1892; the Winchester single-shot rifle; the Marlin repeating rifle, Model 1894; and the Remington-U. M. C. slide-action sporting rifle.

The cartridge is not a particularly accurate one beyond 150 yards, and is not suitable for shots beyond 200 yards, both on account of its rather poor accuracy and very high trajectory. The low-pressure smokeless, and freshly loaded, black-powder loads will group their shots in about a 4-inch circle at 100 yards, but after 150 yards the accuracy falls off very fast. The high-velocity cartridge is not as accurate at any range as the low-power cartridge, but it has much more killing power for short-range work. This cartridge has been used on all kinds of game, but it is really not satisfactory for anything larger than deer and black bear. Owing to its being about the only satisfactory repeater in use during the latter days of the opening of our West, it was much used there and gained the reputation of having *wounded* more game than any other cartridge made. Nevertheless it is a very good deer cartridge for short-range shooting.

.45-70 CARTRIDGE

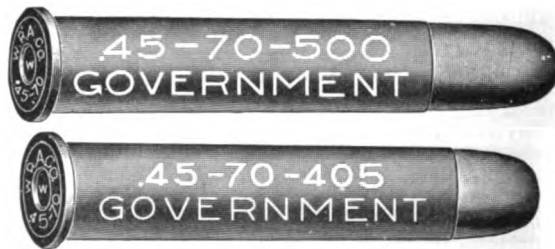

This cartridge was first manufactured for the United States Springfield single-shot rifle which was the arm of the United States Army prior to 1892, when the first model of the Krag-Jorgensen rifle was adapted. It was loaded by the government arsenal with a 500-grain lead bullet and 70 grains of F. G. black powder for the Springfield rifle, and with a 405-grain lead bullet and 55 grains of F. G. black

powder for the Springfield carbine. At present the Winchester Model 1886 repeating rifle, the Winchester Single-Shot Rifle, and the Marlin Model 1895 repeating rifle are the only arms being manufactured for this cartridge.

We have a great variety of loads on the market at the present time for this cartridge as the following list will show :

Bullet weight	Powder	Muzzle velocity, feet per second	Make
500 L & J	Black and smokeless	1201	Win. & U. M. C.
405 L & J	Black and smokeless	1318	Win. & U. M. C.
350 L & J	Black and smokeless	1344	Winchester
330 L	Black and smokeless	1380	Winchester
300 J	High velocity smokeless	1888	Win. & U. M. C.
432 J	Smokeless	1340	U. M. C.
345 L	Black	1390	U. M. C.

L—Lead bullet. J—Jacketed bullet.

The following tables give the ballistics of the United States Government cartridges loaded with black powder :

ELEVATIONS

Range, yards	Rifle, 500-grain bullet 70 grains powder	Carbine, 405-grain bullet, 55 grains powder
100	17 53	22 32
200	31 18	31 23
300	44 58	43 15
400	1 0 32	58 30
500	1 17 18	1 18 36
600	1 34 30	1 40 12
700	1 52 36	2 03 23
800	2 12 02	2 27 22
900	2 34 36	2 52 52
1000	2 58 10	3 19 53

These angles of elevation are taken directly from the arms.

VELOCITY AND ENERGY

Range, yards	Rifle		Carbine	
	500-grain bullet	70 grains powder	405-grain bullet	55 grains powder
	Velocity, feet per second	Energy, foot pounds	Velocity, feet per second	Energy, foot pounds
Muzzle	1,316	1,921	1,150	1,189
100	1,172	1,525	1,018	930
200	1,059	1,245	913	749
300	986	1,079	827	616
400	932	965	757	515
500	886	872	697	437
600	844	792	646	376
700	807	723	602	326
800	772	662	564	286
900	741	609	530	253
1000	712	562	500	225

Note: These velocities were taken with the regular Springfield rifles and

carbines, the rifle having a barrel 32.6 inches long, and the carbine one of 22 inches. The regular rifle cartridge with 500-grain bullet gives a muzzle velocity of 1201 feet per second in a 26-inch sporting rifle barrel.

CHAMBER PRESSURE

The chamber pressure with the rifle, and the 500 grain bullet, 70 grains of black powder, is about 25,000 pounds per square inch.

ORDINATES OF TRAJECTORY ABOVE LINE OF SIGHT-RIFLE

Horizontal distance, yards	Height in feet at									
	100 yards	200 yards	300 yards	400 yards	500 yards	600 yards	700 yards	800 yards	900 yards	1000 yards
200	1.1	0								
300	2.3	2.4	0							
400	3.7	5.1	4.1	0						
500	5.1	7.9	8.4	5.7	0					
600	6.6	10.9	13.0	11.9	7.6	0				
700	8.1	14.1	17.6	18.3	15.4	9.4	0			
800	9.8	17.4	22.6	24.7	23.9	19.6	11.9	0		
900	11.6	21.0	28.2	32.3	33.5	31.2	25.5	15.5	0	
1000	13.5	24.8	34.0	40.3	43.4	43.4	39.8	32.1	18.5	0

The following are the ballistic data given by the Winchester Repeating Arms Company for their black and low-pressure smokeless cartridges in Winchester rifles having a barrel length of 26 inches:

Weight of bullet	500	405	350	330	grains
Muzzle velocity	1,201	1,318	1,343	1,380	feet per second
Velocity at 100 yards	1,082	1,143	1,139	1,155	feet per second
Muzzle energy	1,602	1,562	1,403	1,396	foot pounds
Energy at 100 yards	1,317	1,176	1,009	974	foot pounds
100 yard trajectory, height at 50 yards	3.35	2.90	2.86	2.75	inches
200 yard trajectory, height at 100 yards	14.82	13.27	14.96	13.05	inches
300 yard trajectory, height at 150 yards	36.12	33.55	34.32	33.78	inches
Penetration, lead bullet, $\frac{7}{8}$ -inch boards	18	13	13	10	boards
Diameter of bullet456	.456	.456	.456	inch
Groove diameter of barrel, about457	.457	.457	.457	inch
Twist of rifling, one turn in	20	20	20	20	inches
Powder charge, F. G. black	70	70	70	70	grains

Note: The twist of rifling in the Springfield rifle is one turn in 22 inches.

The following are the ballistic data for the Winchester high-velocity cartridge:

Muzzle velocity	1,888	feet per second
Velocity at 100 yards	1,539	feet per second
Muzzle energy	2,375	foot pounds
Energy at 100 yards	1,579	foot pounds
100 yard trajectory, height at 50 yards	1.47	inches
200 yard trajectory, height at 100 yards	7.40	inches

Penetration, 7/8-inch pine boards	13 boards
Bullet, soft point jacketed	300 grains
Diameter of bullet450 inch
Standard pressure, pounds per square inch	23,000 to 25,000

ACCURACY

Under good conditions, with freshly loaded ammunition, the .45-70-500 and .45-70-405 cartridges will group their shots in about a 5-inch circle at 200 yards, and in about an 18-inch circle at 500 yards. The .45-70-350 and the .45-70-330 Gould hollow-point cartridges will group their shots in about an 8-inch circle at 200 yards. The Winchester high-velocity cartridge will group its shots in about an 8-inch circle at 200 yards, but its accuracy falls off very quickly after passing 200 yards; it being essentially a short-range cartridge where great power is desired, and flat trajectory over 200 yards. In killing power on game the high-velocity cartridge will be found best for broadside shots on most game, but taking it all around, game in all positions, the cartridges loaded with 500- and 405-grain bullets are much the best killing loads. These last cartridges are powerful enough for all American game, and the high-velocity cartridge for all game except moose and large bear.

This is an excellent cartridge for big game shooting where long shots are not expected. It combines power, accuracy, and a practically unlimited accuracy life. The recoil is rather severe to the novice, but nothing to speak of to the seasoned shot. This cartridge can be reloaded to give greatly increased power, but caution is needed in so reloading it, as there are in use many rifles for this cartridge that have been fired many thousands of rounds, and in which the breech bolt does not breech up as tightly as it should. The following load will be found to be exceedingly powerful, but it should only be used in new rifles, or rifles in first-class condition, and the powder charge should be weighed and not measured. Use the Winchester 405-grain, soft-point, jacketed bullet. The powder charge should be 50 grains weight of Du Pont military rifle powder No. 20. This load will give a velocity of about 1700 feet per second, and a chamber pressure of about 32,000 pounds per square inch. Forty-four grains' weight of this powder with the same bullet gives a velocity of 1490 feet per second at a testing range of 50 feet, and a breech pressure of 22,000 pounds per square inch and is a very good load. The best reduced load that I know of for short range and gallery work is the 405-grain lead bullet, cast of 1 part of tin to 25 of lead, and 35 grains bulk of Hazards F. G. black

powder. This load is very good up to 100 yards, and was much used in gallery work by the New York National Guard prior to the Spanish-American War.

.45-90 WINCHESTER CENTER-FIRE CARTRIDGE



This cartridge is adapted to the Winchester Model 1886 repeating rifle, the Winchester single-shot rifle, and the Marlin Model 1895 repeating rifle. It is very similar to the .45-70 cartridge, being slightly longer, and containing 20 grains more powder. Two types of cartridges are loaded by the ammunition factories. One with black or low-pressure smokeless powder, and the other a high-velocity cartridge: The following table gives the ballistic data for these cartridges:

	Black and smokeless	High velocity
Muzzle velocity	1,532	1,992 feet per second
Velocity at 100 yards	1,248	1,621 feet per second
Muzzle energy	1,563	2,644 foot pounds
Energy at 100 yards	1,037	1,752 foot pounds
100 yard trajectory, height at 50 yards.....	2.28	1.41 inches
200 yard trajectory, height at 100 yards ...	11.24	6.63 inches
Penetration, lead bullet, 3/8-inch boards	13	— boards
Penetration, soft point bullet, 3/8-inch boards	15	14 boards
Weight of bullet, lead or jacketed	300	300 grains
Diameter of bullet456	.456 inch
Groove diameter of barrel, about457	.457 inch
Twist of rifling, one turn in	32	32 inches
Powder charge, F. G. black powder	90	— grains

This cartridge can also be reloaded with the following powder charges and bullets to give superior ballistics:

Bullet, weight	Powder	Charge, grains weight	Velocity, feet per second	Pressure, pounds per square inch
300 M. P.	Du Pont Military No. 20	57	1,996	30,880
350 M. P.	" " " No. 20	53.5	1,851	28,100
405 M. P.	" " " No. 20	52.3	1,784	28,650
300 M. P.	" " Sporting No. 80	31.2	1,600*	low
300 M. P.	" " Imp. Mil. No. 16	68	2,325	35,000*

* Estimated

The last listed load gives great killing power, but is not as accurate as the others, particularly at ranges over 150 yards. It must be re-

remembered that the faster one speeds up a short, blunt pointed bullet like the .45-caliber 300 grain, the poorer the accuracy will be. Such bullets are really not accurate except at very low velocities.

The regular .45-90 cartridge gives good accuracy up to 100 yards, and fair accuracy up to 200 yards. At 200 yards, good ammunition in a good rifle should keep all shots in about a 10-inch circle. The high-velocity cartridge will not do quite as well as this at 200 yards, but at 100 yards there is practically no difference between the two.

This is an excellent cartridge for all but the very largest game at ranges up to 200 yards. It used to be a very popular big game cartridge, but of late years has had to give away to the small-bore, high-velocity arms.

CHAPTER XII

MODERN RIFLE POWDERS¹

HISTORICAL

GUNPOWDER has been known by the inhabitants of China and India almost since prehistoric times. We find reference to it in some works compiled before the Christian era. It was not until about the year 1320 that it became generally known in Central Europe. As far as known there was very little difference between these early powders and our black powder as we know it today. All were a mechanical mixture of sulphur, saltpeter, and charcoal. There has been comparatively little development in black powder during the past century, except as to the refinement, methods of manufacture, and granulation.

As has been stated in Chapter I, the first successful smokeless powder was that invented by Schultze, and made almost entirely from gun-cotton. It was applied almost exclusively to shotguns, but some rather unsuccessful experiments with rifles of low velocity were made with it. The shotgun presented an easier problem than the rifle, and this is the reason why a shotgun powder was the first successful one. In the case of the shotgun the type of projectile used is a limitation which stands hopelessly in the way of attainment of higher velocity, and consequent increase of range. The rifle presents a problem in which the attainment of higher velocity is not limited by the form of the projectile. Accuracy is attained by the use of a single projectile fitted exactly to the barrel, and high velocity is possible because the form of that projectile is not limited to a sphere. The forerunner of the rifle, the smooth-bore gun, was used with a round bullet, and the velocity obtainable was limited by the air resistance to the surface of a sphere.

Upon the development of the rifle it was quickly found that a cylindrical bullet could be used, which overcame the resistance of the air much better than the sphere. Then came a contest for high velocity between rifle and powder manufacturers to produce a rifle strong

¹The author desires to acknowledge the great assistance rendered by E. I. du Pont de Nemours & Company in the preparation of this chapter.

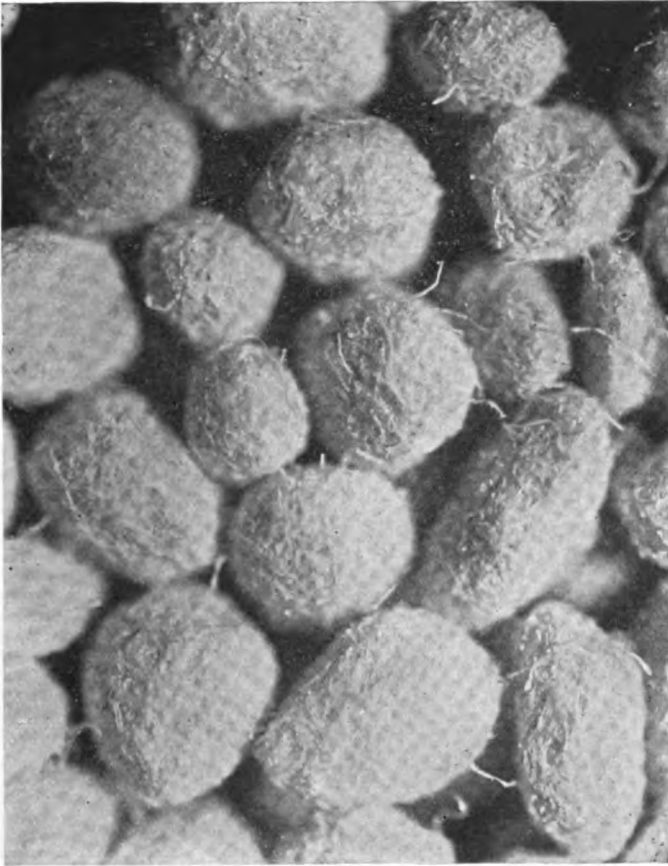

Fig. 73
Schultze shotgun powder. The first successful smokeless powder.
400 times actual size

enough to withstand the pressure developed by powder sufficiently powerful to give a velocity which would meet demands created by the possibilities which people foresaw. Air resistance was cut down by making the diameter of the bullet smaller and smaller, and weight was increased by making the bullet longer, thus having the air resistance applied to the smallest possible area and putting all the mass possible behind it, in which mass energy is stored, having been imparted to it by means of the powder.

It was not long before the black-powder manufacturer reached the limit of development in the contest. This powder, by its nature, is

capable only of a moderate amount of improvement. It gives a relative small quantity of gas in proportion to its volume. If the high velocity now obtainable with modern powders were attempted with black powder, the volume of the shell would have to be nearly three times as great as it now is. This would make a clumsy cartridge to handle, and the parts making up the breech mechanism of the rifle would have to be correspondingly enlarged so that the result would be a monstrosity. Also black powder leaves a heavy residue in the bore. With the best of conditions this residue causes a slight falling off of accuracy after from five to fifty shots have been fired from the rifle without cleaning, and when it was attempted to increase velocity by decreasing the caliber, lengthening the bullet, and increasing the powder charge, the increase in the residue was so great as to destroy the accuracy unless the bore was cleaned after every shot. Military requirements have always played an important part in the development of the rifle, and its cartridge, and besides high velocity, and consequent low trajectory, the military requirements have always demanded a powder which shall give forth as little smoke as possible both in order that the exact position of the firing troops shall not at once be disclosed to their enemy, and also that there be not a large cloud of smoke in front of the firing line to interfere with, or totally obscure, the aim at the hostile target. The latter requirement also has its importance from a sporting standpoint.

It has been stated that the first successful smokeless powder was for shotguns. Control of rate of burning of guncotton was not mastered for some years after the first shotgun powder appeared. The quick burning and low pressure required made the main factors of the problem an easy one for shotguns, but when the knowledge thus far gained was applied to military rifles immediate success was not forthcoming. Control of nitration, colloidizing, ignition, and hygroscopic qualities were not understood as they are now, and the result was that early smokeless powders applied to rifles were far from satisfactory. These early powders were, of course, made to suit the requirements of black-powder rifles, and these, on account of their design, must be operated at very low pressure. The art of smokeless powder manufacture reached a critical point in its development when Vieille, in 1886, perceived how important was the use of solvents. For the first time nitrocellulose was completely gelatinized, and made into squares. This was the first military powder. It was soon followed by ballistite, invented by Sir Alfred Nobel, then by cordite, invented by Sir Frederic

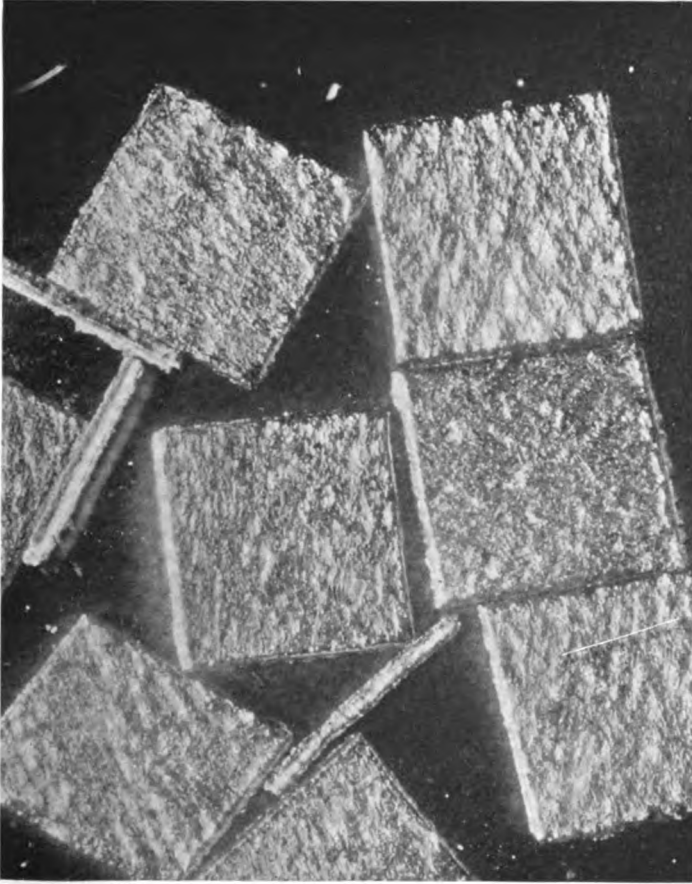

Fig. 74
Ballistite powder. 400 times actual size

Abel. Both of these powders contained nitroglycerine. No attempt was made to obtain progressive burning by using a perforated powder until experiments in the manufacture of a perforated grain were begun independently, but almost simultaneously, by Francis G. du Pont and Colonel Whistler.

The next development in smokeless powder was the improvement of the grain. If a solid form of grain is ignited, like the grains of black powder or any grain without perforation, the burning surface begins to decrease immediately after ignition. As the grain burns it gets smaller and smaller, and as a consequence there is a decrease in the

evolution of gas. This decrease comes at a very inconvenient time, just when the projectile is getting up speed, and needs all the push behind it that it can get. Suppose, however, we make our powder grains in the form of short cylinders, and through the center of each cylinder make a small hole or perforation. When a grain of this form burns, the interior surface, inside the perforation, begins to increase immediately upon ignition, and continues to do so with an increasing production of gas until this surface meets the steadily decreasing exterior surface of the grain, at which time the grain is consumed. With such a grain the increase in the interior burning surface and the decrease in the exterior burning surface about balance each other, thus there is a steady maintenance of gas production until the grain is completely consumed. Such powder is called "regular burning powder."

With regular burning powder the pressure begins to fall off as the projectile starts forward in its passage through the barrel, because the space the powder has to burn in is steadily increasing. This condition is not ideal. What we want is a steadily increasing push up to the point where the bullet leaves the muzzle in order to increase velocity, as with the regular burning powder the velocity is limited by the permissible pressure exerted by the gases at their maximum pressure, that is the breech pressure. It will be evident that if we take a cylindrical grain and increase the number of holes or perforations through it we will soon arrive at that point where the interior burning surface will increase faster than the exterior burning surface decreases. In other words, our grain will constantly throw off more and more gas until it is completely consumed, that is it burns "progressively." This principle was applied to early smokeless powders for cannon, finally ending in a grain with nineteen perforations. This final form of grain, however, was abandoned because it was too progressive, and the pressure at the muzzle too high. In the case of cannon, weight at the muzzle to strengthen it to meet the pressure at this point is objectionable, also vibrations are set up, coincident with high muzzle pressure, that cause bursting of the gun even though, seemingly, the pressure is not great enough to cause disaster.

Now the manufacture of smokeless powder for rifles is limited to a grain of cylindrical form having a single perforation, because a grain having more than one perforation would be so large that accuracy in measuring charges by machinery, and a required variation of the powder charge for various rifles, would be impossible. This limita-

tion has caused our powdermakers to look elsewhere than towards the form of grain alone for obtaining the progressive burning qualities so earnestly sought. It was then found that by coating the grain of ordinary powder with another powder of slightly different composition it was possible to cause the grain to burn slowly while the coating was being consumed, in other words, to burn progressively. This started the bullet on its way with a gentle push, and thus avoided the shock caused by the ignition of regular burning powder at high pressure. Any rifle is capable of being operated at a certain pressure, taking into consideration a reasonable safety factor. Let us suppose that the permissible working pressure is 50,000 pounds per square inch, and that with this pressure, and regular burning powder, a muzzle velocity of 2700 feet per second is attained. When we come to use a progressive, or coated, powder in this arm we find that owing to the sustained push throughout the length of the bore we are able to get this 2700 feet per second velocity with a breech pressure of only 45,000 pounds. Our rifle will stand 50,000 pounds working pressure, therefore we are able to use more of the progressive burning powder, and when we use enough of this powder to give 50,000 pounds pressure we find our velocity has increased to about 3000 feet per second. This progressive burning powder marks the latest development in modern rifle powders, the first successful powder of this type having appeared in 1914. While these powders have considerably increased the ballistic efficiency of existing rifles, the full advantage of them will not be realized until they are applied to a rifle and cartridge expressly designed to obtain the maximum advantage from them. In this respect the .30 Newton cartridge would seem to be a step in the right direction.

It is difficult to ascertain just where the first idea of coating powder to make it burn progressively originated. The first experiments that showed any positive indication of success were performed in 1901 by Dr. William J. Williams, chemist for the Ordnance Department, United States Army, and by J. C. Carr, ballistic engineer at Frankford Arsenal. The work was brought to the attention of Francis G. du Pont, who examined samples of powder treated by Dr. Williams, and decided that the improvement had little value. Again the attention of the Du Pont Company was called to it in subsequent years, and finally in 1905 some samples were very carefully prepared and tested in comparison with ordinary powder at two different ballistic stations by different operators. The result indicated little advantage. Not many years after this it became known that a progressive powder was manufactured in

Germany, and the advantage that this powder had was apparently that a higher velocity was obtained with a pressure that was not excessive. The lack of success in the perfection of a progressive powder in this country was due to the fact that the military rifle, in which all experiments were carried on, used a nitroglycerine powder, and the process invented by Dr. Williams did not adapt itself with advantage to this type of powder. In subsequent years experiments were taken up independently of the Du Pont Company with the advantage of all the information that could be obtained on the manufacture of progressive powders. The series of powders now in use were brought out, and their superiority is due to the care taken in their gradual development, the result of years of experience, and the adoption of only the best inventions and suggestions.

MANUFACTURE OF MODERN POWDERS

The different types of smokeless powder having been carried through their development, it will be of interest to the riflemen to learn something about their manufacture. Few manufacturing processes differ more widely than black and smokeless powder. The former is chiefly mechanical; that is, being assured of the purity of the ingredients all that remains is to put them together properly, and in a day or two the finished product is ready for use. In fact in the olden times the ingredients of black powder were carried separately by armies, and the powder mixed on the battlefield. The manufacture of smokeless powder, however, from the beginning to the turning out of the finished product, requires at least three weeks. It is a chemical process throughout, and laboratory control is necessary at every stage.

Smokeless powder used by various governments, and for sporting purposes, is of two kinds, sometimes classified as "single-base" powders, and "double-base" powders. Single-base powders are made from straight nitrocellulose without the admixture of any other ingredient except a small amount of some stabilizing material. Double-base powders are made from a mixture of nitrocellulose and nitroglycerine. The principal governments using single-base powders are the United States, France, and Russia, while those using double base powders are England, Italy, and Spain.

The powder used by the United States Army and Navy is a pure nitrocellulose powder, to which is added 0.5 per cent. of diphenylamine as a stabilizing agent, and the grains are coated with graphite. Nitrocellulose is a material obtained by treating cellulose in a mixture of

nitric and sulphuric acids. It is frequently referred to as guncotton, collodion cotton, soluble cotton, etc. Our own nitrocellulose has a nitrogen content of between 12.50 per cent. and 12.70 per cent., which is not less than 95 per cent. soluble in a mixture of two parts of ether and one of ethyl alcohol. It is common to refer to this grade of nitrocellulose as "pyro," which has a definite meaning to powder manufacturers in the United States. Guncotton, strictly speaking, has reference to a particular form of nitrocellulose of higher nitration, usually between 13 per cent. and 13.40 per cent., which is only slightly soluble in the mixture of ether and ethyl alcohol.

At most powder mills the construction of smokeless powder begins with the manufacture of nitric and sulphuric acid, and with the purification of crude cotton fiber of the grade called "linters." To purify the cotton it is heated for several hours in a caustic soda solution. The purification of this and the acids requires an immense amount of laboratory work. After manufacture, the nitric and sulphuric acids are mixed, and the mixture checked by chemical analysis. The mixture is maintained at an even temperature, and the cotton in a dry state is immersed in it. This is done by machinery, and is called "nitrating." The cotton is changed into nitrate of cellulose, or "nitrocellulose," and water by the action of the nitric acid. The sulphuric acid present absorbs the water formed, and prevents it from causing hydrolysis which would otherwise result. The nitrocellulose is then placed in a centrifugal wringer, and as much of the acid extracted as possible. This acid has been considerably weakened by the giving up of combined nitrogen, and the taking on of water, but it can be fortified by the admixture of strong nitric and sulphuric acids in the proper proportions and used again. The nitrocellulose taken from the wringer, and containing a considerable quantity of acid, is immersed in water immediately, otherwise it would soon catch fire spontaneously. Nitrocellulose of various strengths is made by changing the strength of the acid mixture. Chemical analysis of the acids is constantly made to make sure that the desired grade of nitrocellulose is being turned out. This nitrocellulose in water is transported in wooden tubs in which it is boiled for forty-eight hours to set it free from acid. It is necessary to keep the water in an acid condition, but not too strongly so, for a portion of the time, consequently frequent chemical tests must be resorted to. When boiling is complete the nitrocellulose is reduced to pulp by machinery similar to that used in a paper mill, and the laboratory is again called upon to determine the fineness of the pulping. Proper regulation of

the pulping has an important bearing upon the quality of the finished powder. When the pulping is complete the product is transferred to "poachers," or large tubs, where a further boiling treatment, with agitation, is given to set free any acid which was imprisoned inside the individual fibers. The nitrocellulose is boiled six times for periods of five hours each, and the water changed each time. Then it is washed ten times, the water being changed each time, after which a complete set of chemical tests is made upon each lot to determine its content of nitrogen, solubility, viscosity, stability, and per cent. of ash. Having passed the prescribed tests, it is ready to be made into powder. There are three different kinds of powder, single-base bulk, nitroglycerine or double base, and single-base dense.

Bulk powder manufacture. The wet nitrocellulose is placed in a still fitted with an agitator, and containing a solution of barium and potassium nitrates. While the mass is being stirred, a solvent consisting of a mixture of amyl acetate, benzol, and paraffin oil is introduced. This solvent, being insoluble in water, separates into globules. Each globule dissolves a certain amount of nitrocellulose, and by reason of the agitation they retain their separation. Heat is applied to the still, and the solvent is boiled off, leaving hard grains of nitrocellulose. Grinding, sieving, drying, seasoning, blending, and packing follow in the order given. The chemical laboratory controls the entire operation with tests to determine the strength of solutions, proportions of ingredients, amount of volatiles left in the powder, amount of ash, and many other features on which the reliability of the finished product depends. This process is original with the Du Pont works, and was invented by Francis G. du Pont. It is the same process by which Du Pont shotgun powder is made.

Nitroglycerine powder. Wet nitrocellulose is set free from water by forcing alcohol through it, displacing the water. This is done in a hydraulic press, and the nitrocellulose, soaked in alcohol, is squeezed until there is left in it only a small quantity of alcohol. This process was also invented by Francis G. du Pont, and is called "dehydration." Previous to this invention it was necessary to dry all the nitrocellulose — an exceedingly dangerous undertaking, and one which had many fatal consequences. The nitrocellulose containing alcohol is placed in a mixing machine. Nitroglycerine and acetone are mixed with it, the operation being, of course, a dangerous one. Then it is placed in a hydraulic press and made to pass through dies which give to it the form of tubes or perforated cylinders. These tubes are cut into slices

or short lengths, and as a result, grains are produced cylindrical in form with a central perforation. The length of cut, the diameter of the tube, and the diameter of the perforation are changed in accordance with the use to which the powder is to be put, the principle being approximately as follows: A powder for the .45-90 Winchester cartridge must burn quickly, therefore the cut is very short and the perforation large. A powder for the United States rifle, Model of 1903, must be slower burning, therefore the grain is as long as possible, the length being limited by the difficulty encountered in loading accurate charges into the cartridge shells by machinery. The diameter of such grains is small and the perforation exceedingly small.

Drying, sieving, blending, and packing follow in the order given, the entire group of operations being controlled by the chemical and ballistic laboratories.

Nitrocellulose powders. These are also known as "single-base dense rifle powders." The process of manufacture of these powders is similar to that of nitroglycerine powders as far as dehydration. After this the alcohol-bearing nitrocellulose is sieved, placed in a mixer, and ether, diphenylamine, and graphite are added. Diphenylamine is a compound which insures chemical stability. Its introduction in 1908 was an important step in the improvement of all kinds of smokeless powders. When the mixing is complete the mass is transferred to a hydraulic press, and compacted into a cylinder about 12 inches in diameter and 18 inches long. Several cylinders are placed in a finishing press by means of which the powder is pressed through dies as described for nitroglycerine powders, only the average size of the tubes are much smaller than the nitroglycerine powders. The strings or tubes of powder, as they come out of the dies, are fed into a machine which cuts them accurately into grains having a uniform length. The granulated powder is placed in an apparatus called "solvent recovery" where the ether contained in it is volatilized by a current of warm air, then condensed. By this means an important economy in the use of ether is effected, as well as control of the shrinkage of the powder which has an important bearing on its quality. This solvent recovery process was also the invention of Francis G. du Pont. All of the ether necessary to be extracted cannot economically be taken out by the solvent recovery, however, and the powder has to be placed in warm water and kept there for about a week. This process is called "water drying." Then the powder is dried by a current of warm air, glazed, sieved, banded, and packed. Chemical control exerts a most important

influence throughout the manufacture of this kind of powder. The amount of solvent left in the powder after solvent recovery and water drying treatment has to be ascertained, and many other properties must be controlled and watched.

Progressive powders. The process is the same as for the powder just described, except that the coating material is made to adhere to the grain before glazing. We have, as a result, a grain made of pure nitrocellulose, coated and partly impregnated with a layer of slow-burning material, and imposed upon this a thin layer of graphite. The progressive properties of the powder can be controlled by changes in the size of grain, and changes in the thickness of coating. The rate of burning of this coating material likewise has an important influence upon the progressive features of the powder, and is being given close study. There is probably room for further improvement in this type of powder, and it may be that within a few years a combination of rifle and powder will be developed in which the velocity will be much higher than anything heretofore attained.

THE COMBUSTION OF MODERN POWDERS

In considering the combustion of modern powders we must first define what an explosion is. A good definition for the word "explosion" is "the transformation of a solid into gases in a limited time." Powder is said to "burn," speaking technically, and if we use that term the process may be easier understood. When a stick of oak wood burns in a stove it undergoes the same process in a slow manner. If the stick be pine it burns somewhat faster. If, again, the same amount of wood be put in the stove in the form of fine, dry shavings it burns in still less time. The latter, though a long way off from it, is most like the form of burning which in powder is popularly called "exploding."

Now the big difference between black and smokeless powder is in the speed of their burning. So far as its composition goes, black powder has only one speed, the speed of its burning being controlled, not by composition, but by the size of the grain. In the open air, or tightly packed behind a bullet, ignited by a white hot flame, or a red hot poker, or by a primer flash, it burns just the same — that is, it explodes. Of course there is some variation in its burning, due to fine or coarse granulation and shape of grains, but this is not important here.

Smokeless powder has two speeds of burning, if we classify its combustion roughly. When ignited in the open air, as when on a board, it burns slowly,— much slower than black powder — and more feebly.

In an enclosed shell, behind a bullet, and when its own expanding gases subject it to a certain pressure that the powder manufacturers know within a few pounds, it burns at a much faster rate. This is faster by far than the one speed of black powder, and is the burning popularly known as "exploding."

At the end of this chapter I will describe twenty or more different modern powders. Nearly all of the twenty are necessary. Few could be dropped without a loss in accuracy, power, or other shooting qualities in certain cartridges. To state the matter in another way, different cartridges, barrels, bullets, and purposes require different powders. In the old black powder days of rifle shooting, which roughly may be defined as the period for a hundred years before 1885, the idea was to get an explosive — any explosive — and then to use that explosive in ways that might be devised. At the present time the idea is to secure an explosive that will fit the conditions of rifle and work under which it must be used. From the explosive ingredients, already named under the manufacture of powder, can be produced, within limits, any result desired. Thus it is no impossibility to manufacture a powder so easily fired that it is dangerous to handle, and so violent in action that it bursts the rifle barrel, while little more than expelling the bullet from the barrel. On the other hand, mixtures can be concocted which possess no more capacity than black powder, and that are harder to ignite. The successful modern rifle powder must conform in nature and action to upwards of a dozen major specifications.

The influence of the rifle, primer, and the bullet on the combustion of the powder must be understood before an intelligent selection can be made of a powder for any particular rifle and purpose. Briefly, the burning of a charge of smokeless powder should be completed by the time the bullet reaches the muzzle of the barrel. To accomplish this seemingly simple result, however, the powder must meet at least five conditions. First, each cartridge or load is intended to give a certain velocity to the bullet. To drive the particular bullet at the required speed requires a certain push or pressure, therefore the powder must burn uniformly, safely, and otherwise satisfactorily at this pressure. Second, only a certain limited period of time is available for the burning process, and this time is determined by the velocity of the bullet in the barrel, and by the length of the barrel. Thus the .30-40 Krag cartridge with 220-grain bullet at a standard muzzle velocity of 2000 feet per second from a 30-inch barrel gives a much longer burning period than the same cartridge loaded with 150- or 170-grain bullets

at 2300 to 2600 feet and fired from a 24-inch barrel, hence one reason why the latter load should use a different powder from the former.

Third, the powder must burn correctly, neither too slowly, too quickly, nor too violently, in the particular combustion chamber. A .45-70 or even a .32-40 shell, for example, presents a totally different problem from a .22 high-power shell. In the former the burning powder drives straight away from the primer, while in the latter some of the hot, expanding gas is caused by the abrupt bottle neck to curve or churn back into itself, and into any powder not yet burning, with the result that the combustion is hastened and intensified.

Fourth, the powder must ignite freely from the flame of suitable primers, and every grain must begin to burn, those in the front end of the charge as well as those in rear. Smokeless powder is harder to ignite than black powder, hence special primers are employed. It will be noticed that certain primers in the manufacturers' lists are marked "for smokeless powder" and these only should be used with this kind of powder. Even at that one or two of the earlier powders ignited so slowly that target shooters sometimes assisted the primers by loading in the bottom of the shell a few grains of black powder or other easily ignited powder. Yet smokeless powders are so sensitive to ignition that the hot flash of an inordinately strong primer runs the pressures up excessively.

Fifth, the powder must ignite properly in the amount required for the charge. For example, the very small charge required in a .22 rim-fire, or .32 center-fire cartridge can be penetrated easily by the primer flash, or ignited throughout by self-generated heat without delay, but the large, long charge of a .45-70 or .30-1906 cartridge is harder to fire evenly and quickly. Even more important, the powder used in the small charge, if ignited in large amounts, flashes too quickly, and generates too much heat and pressure, while the correct powder for the large charge, in its own shell, fails to ignite or to burn completely when used in too small amounts.

Summed up, these five factors taken together require that the powder ignite properly, and burn at the right pressure while developing the required velocity under the particular conditions of each rifle and cartridge. When it burns at a higher or lower pressure a train of evil results follow, including unevenness, inaccuracy, lower velocity, metal fouling, and sometimes positive danger. Some of the first smokeless powders on the market, as for instance Hercules W. A., were designed for use in particular rifles and cartridges. When attempts were made

to use them in other cartridges they failed to give satisfaction. An example of this was the effort to use W. A. powder made for the .30-40-220 Krag cartridge in the .30-caliber Model 1906 cartridge which resulted poorly. A good cartridge came near being condemned because of the unsuitable powder used in it at the start. Until very recently numerous hunting cartridges were on the market which were inferior in one or more respects for the same reason, although they had much merit in design.

FACTORS THAT CONTROL PRESSURE

Various means are available for controlling the pressure at which the powder burns in the shell. Some of them are through the rifle and manner of loading, as by the amount of powder taken for the charge. As the charge is increased the pressure builds up faster than the proportionate weight. When heavy charges are used in such a way as to give pressures near the maximum limit for that powder or rifle, one or two grains more may cause a variation in several thousand pounds in the pressure generated.

The influence of the shape of the combustion chamber on the burning of the powder, already mentioned, extends of course, to the pressures generated. To illustrate, the powder capacities of the .22 high-power shell, and the .401 Winchester self-loading shell are about the same, but each of necessity uses its own type of smokeless powder. If the charges be switched, the .401 bullet will be given but little velocity and the rifle action will fail to function, while the .22 high-power cartridge will give dangerous pressure. In the straight shell of the .401 the powder that is correct for the .22 high-power, fails to burn completely, while in the severely bottle-necked shell of the .22 high-power the powder correct for the .401 churns its gases to enormous pressure. This example is extreme, and the above are two cartridges in which the powder cannot be exchanged at all. There are many other cartridges less radically different in which the shell shape clearly indicates the use of certain powders for best results, but in which other powders can be used with fair satisfaction.

The resistance of the bullet is another factor in controlling the pressure. A bullet that offers little resistance permits a powder charge to burn behind it with the minimum of pressure, while one that offers more resistance will cause the same powder charge to develop much higher pressure. Years ago when the first dense smokeless powders were placed on the market the .45-70 cartridge was loaded

with a certain one. The results were good when the shell was heavily crimped, thus confining the powder gases in the shell until the combustion was more or less advanced. But this powder would give practically no velocity at all when the bullet was not tightly crimped, although the primer flash was strong enough to shove the bullet an inch or two into the barrel.

Bullet resistance, in addition to crimp of shell, depends upon its weight, and on the friction developed in the barrel. The latter in turn depends upon the hardness of the alloy of which it is made, or the hardness of the metal of the jacket, on the length of bearing surface of the bullet in the barrel, on the depth of lands in the barrel, on the diameter of the bullet in relation to the size of the bore of the barrel, and on the amount of clearance about the neck of the shell and the front of the bullet. All these factors must be taken into account when a powder is designed or selected for any particular cartridge or loading.

In the powder itself very important means of controlling pressures are available. Finely grained powder, of course, burns faster, and hence sets up higher pressures than coarse powder, just as the shavings burn faster and hotter in the limited time than the solid stick of wood. Black powder granulation was and is varied, but only as to size. Smokeless powder granulation is varied as much or more in size, and in addition is varied greatly as to shape of grain. Most of the Du Pont series of dense powders, for example, have grains the shape of short pieces of tube. They burn on the inside as well as the outside of the tube. These dense powder grains are very uniform in size, which means that they always burn the same within narrow limits. Some particular brands, however, are very fine, and they burn so fast that their combustion takes place at the maximum permissible speed and pressure, the only variation being due to the way in which the ignition happens to vary through the powder lying back against the primer without air space, or failing to fill the rear end of the shell completely, which may be a matter of the position of the cartridge, and elevation of the rifle barrel.

Of almost equal importance in control of pressure is the composition of the powder. Some ingredients are capable of generating much greater volume of gases than others, grain for grain, bulk for bulk. For instance, Du Pont No. 1 smokeless rifle powder cannot possibly give as much pressure as Du Pont No. 75, or as Hercules Unique, owing to the ingredients used. This is a direct strength comparison. Much more subtle differences exist, wherein the final pressure result-

ing is not so much a matter of actual concentration of potential gases as of the manner in which the ingredients used burn and give off their gases. The pressure generated by Hercules HiVel powder, for example, in correct charge in the .280 Ross cartridge is very much higher than the pressure of an equivalent charge of Du Pont No. 10 powder, due to the different components; while the pressure given by Du Pont No. 15 or 13 progressive powders to produce the same bullet velocities in this cartridge are lower yet, due to the difference in the way the more or less slightly varying components burn. The actual volume of gases with Nos. 10, 15, and 13 powders probably vary little. This matter of the way in which a powder burns deserves emphasis, as on it hinges some of the most important distinctions between powders that are good and others that are better. Black powder and the finer grained smokeless powders burn like a flash, so to speak. They set up their maximum pressure right in the chamber, and exert force on the bullet largely in the form of a blow, followed by a decreasing pressure as the bullet travels up the barrel. Other smokeless powders, such as Du Pont No. 20, Du Pont No. 21 and Du Pont No. 10, burn steadily, and are burned completely only when the bullet has reached the muzzle of the barrel, maintaining pressure on the bullet all the way up the barrel. Grains nearest the primer apparently are well onward in combustion before those at the front end of the charge are more than started, and it is these front grains, adding to the gases, which keep up the pressure. This type of powder is known as the "regular" burning kind. Still other powders, of more recent introduction, such as the Du Pont Nos. 15, 16, 18, and 13, known as progressive burning powders, apparently ignite throughout the charge as quickly as the regular burners, but burn more slowly, due to the way in which they are coated with a slower burning compound. Combustion is complete by the time the bullet reaches the muzzle, but from the time the bullet starts from the chamber the volume of gas steadily mounts higher and higher, the force being applied to the bullet more in the nature of a steadily increasing push than like a blow.

In applying these various fundamental facts to the selection of a powder for a particular cartridge or load in any certain rifle barrel, we must, therefore, look for a chemical composition and shape and size of grain that will insure complete burning within the barrel length during the time available, and at the pressure required. Furthermore, the burning must take place in the manner required to give the bullet used the essential velocity with the pressure permissible. To

illustrate, a powder that will burn completely in a revolver, or even in a carbine of small caliber, with their lower pressure and short barrels, cannot possibly meet the conditions of full charges in long barrelled, high-power military or hunting rifles; nor can a hot, violent powder be used where pressures must be high to get ultra high velocities.

Each different size and shape of shell, each different weight, shape, and hardness of bullet, each different caliber and barrel length, develops a different pressure. From this comes the necessity of having so many different smokeless powders, and the necessity also of changing the powder when any of the features of rifle, shell, and bullet are changed to any extent. If the powder is increased or decreased, the air space cut down much or decreased, bullet made heavier or lighter, harder or softer, larger or smaller, or barrel much shortened or lengthened, the kind of powder should be changed accordingly.

NITROGLYCERINE AND NITROCELLULOSE POWDERS

One of the most desirable qualities in a rifle powder is that it shall damage the steel of the barrel as little as possible. To insure this the powder must burn at as low a temperature as possible while developing necessary pressures. The temperature developed seems to depend more on the ingredients than on any other factor, and of the ingredients, nitrocellulose burns much cooler than nitroglycerine. One of the best illustrations of a hot burning nitroglycerine powder and its effects on the barrel is the old 1908 military powder (now duplicated by Du Pont No. 19, and Hercules HiVel. This powder was first brought out as an improvement on the old W. A. powder which had been used for so many years with success in the Krag cartridge. It was designed to be used in the then new .30 caliber Model 1906 cartridge with 150-grain pointed bullet. So great was its damaging action on barrels that expert military riflemen frequently had to discard barrels for accurate work after only about 400 rounds had been fired from them, on account of the excessive erosion. Another example of the nitroglycerine type of powders is "Sharpshooter." The action of this powder, especially in small bore rifles using small shells, seems to be slightly different, in that corrosion is produced and not erosion, and this corrosion can sometimes be noted, in .25-20 rifles for example, after only 200 rounds have been fired.

The nitrocellulose powders, on the other hand, do not damage the barrels nearly as much. Du Pont No. 20 can be fired in full charges

in the .30-caliber Model 1903 rifle for from 5000 to 15,000 rounds before the accuracy of the barrel is seriously impaired, and it is reported from a number of tests that the newer progressive burning powders, Nos. 15, 18, 13, and 16, especially the two latter, produce little effect even in 20,000 rounds.

Nitroglycerine powders damage the barrels by first softening the steel through heating, and then eroding or washing it away as a stream washes away its banks. The nitrocellulose powders burn cooler, and with them it is possible by increasing the charges to get higher velocities than ever before without serious erosion of the barrel. This matter of erosion is fully covered in Chapters XVII and XVIII.

STABILITY, RESIDUE, AND UNIFORMITY OF BURNING

Stability is essential in any powder. Some powders deteriorate through time, but it must be said that the majority of our American powders are splendid in this respect. Most of the modern military powders, at least, will keep in perfect condition for years in good storage, or when loaded in clean shells. A few powders will absorb moisture, among them Du Pont No. 1, No. 75, and Schuetzen. Powders that will not do this have the advantage.

Stability against changes due to temperature is another important factor. Nitrocellulose powders are not affected much by any range of temperature encountered from pole to equator, but nitroglycerine powders are. So much are the exploding pressures of the latter type of powders increased by extremes of heat that cartridges loaded with them for use in the tropics have several grains less charge.

The residue of a smokeless powder should be as little as possible, and should contain no hard lumps that may get into the chamber and prevent the cartridges seating readily, or into the breech action and interfere with the functioning of the rifle. The residue should be easily removed and non-corrosive as a further element of protection to the rifle bore. In this respect the new progressive burning powders apparently are superior to both the regular burning nitrocellulose and the nitroglycerine powders. Nearly all modern powders are graphited, with the result that the residue they leave in the barrel has lubricating properties of some value.

Uniformity of burning depends somewhat on composition, but more on evenness of granulation and character of grain. Nearly all modern powders are excellent in this respect. Uniformity, however, is secured

only within the range of normal working pressure for each powder. When such pressure is exceeded, or when less is developed, the burning becomes erratic and unreliable.

Muzzle flash, fumes, and smoke are objectionable to some extent. From a military standpoint a flash betrays the location of the firing troops at night.

BULK POWDERS

Concentration of powder deserves more than passing attention. Present day powders are of two distinct types, "bulk powders" and "dense powders." Bulk powders are the oldest, having been introduced in America about 1894, while the true dense powders were unknown to most riflemen until about 1899, although various governments, including the United States, had used different types of dense military powders before that time in small-bore, military rifles.

The first satisfactory smokeless rifle powder was introduced by the Du Pont Company in 1894. This was a bulk powder known as the Du Pont No. 1 rifle smokeless. In those early days of smokeless powder no rifleman or shotgun shooter overlooked a reloading outfit when purchasing a new arm. Normally included in the price of every shotgun was included a three-joint cleaning rod, and a complete outfit for reloading shells. Every rifle manufacturer listed reloading tools in his catalogue, and stores generally sold tools, and no one wasted time or breath in ridiculous cautions or warnings against reloading. With every set of tools, whether for rifle or shotgun, came the conventional dipper, or "scoop" for measuring out the proper charge of *black* powder. Naturally early smokeless powders received the reception accorded to every new thing, including percussion caps in flint-lock days, the breech loader later on, the magazine rifle still more recently, and the small-bore, high power rifle even today among less informed hunters. The "old timers" loved to cling to their ancient customs and beliefs. Many were the objections against the new "white" or "wood" powder. "It was not as strong as black powder." "It rusted the barrel." "You could not use the same caps." "It did not keep well." And a host of other minor complaints. But at the start the manufacturers wisely eliminated one factor that would have been a real complaint, and that would have caused endless trouble in those "black powder days." They made the first smokeless powders measure bulk for bulk with black powder so far as strength or correct charges were concerned. The old scoops

or other measures could be used to measure out the charges without special directions or precautions. The proper charges occupied exactly the same space as the displaced charges of black powder, hence the name "bulk powder."

In developing and perfecting these early bulk powders the manufacturers were naturally greatly handicapped by the limitations of the rifles of that day. Pressures in excess of 28,000 pounds per square inch were unheard of, barrels were of soft steel, bullets were of smaller diameter than the rifle bore (dependence being placed on the blow of black powder explosion to "upset" them and properly seal the bore), and other minor difficulties obstructed progress. The pressure limit was met by producing powders that burned properly and uniformly under the imposed conditions. Soft barrels were taken care of by using practically the present cool burning nitrocellulose composition. Some complaints against the inaccuracy of the new powders developed until the shooters were educated to the fact that smokeless powder lacked the initial blow of black powder that upset the bullet and filled the bore, and that therefore bullets of slightly greater diameter were required. Attention was called to the fact that the corroding of rifle barrels, when using the new powders, was brought on by a different type of fouling, a fouling as easily removed as that of black powder, but demanding different methods of cleaning and solvents. These points are even more vital today than at first. It was gradually found that the new product could be substituted for almost any black powder charge with advantage. This explains the origin and meaning of the term "bulk" powder.

The bulk powders are of a fibrous, porous nature. They might be termed "soft grained" also, as the grains can be crushed between the fingers. The grains are of no such symmetrical and non-varying shape as those of dense powder; some are round while others are exceedingly irregular in outline, resembling the old time Fg black powder.

In the manufacture of bulk smokeless powders, as described on previous pages, the large cakes of combined ingredients are broken up in crushers instead of being forced through dies and made into tubes as are dense powders. The small particles resulting vary in size from dust to the size of small buck shot. These particles are then passed through various screens, and only the desired granulation is retained. For instance Du Pont No. 1 rifle smokeless is sifted through a mesh of 16 to the inch, and caught on screens having 26 meshes

to the inch. All the powder retained between these two screens is of proper granulation, but any failing to pass through the top one is too coarse, and all that falls through the bottom is too fine. On the same basis sporting rifle powder No. 80 is termed a 34-56 granulation.

The rate of burning of bulk powders is not as easily controlled as that of dense brands, because of the soft, irregular grains, without perforation. Size of grain and composition are the only factors that can be manipulated to determine the rate of combustion. The porous nature of the grains of most bulk powders renders them more susceptible to atmospheric changes, also to the deteriorating effect of dirt in old shells, than the dense powders. These are practically the only logical complaints that today can be laid against bulk powders. They will absorb moisture if stored and handled under improper conditions. How keenly the manufacturers realized this point is shown by the improvements in Du Pont sporting rifle powder No. 80, the latest and most modern bulk powder. This brand has been modernized by the addition of an ingredient that to a great extent prevents its absorbing moisture or responding to atmospheric changes. Personally I am unable to see where it does so in the least, as I have had a large amount of this powder with me in the Panama Canal Zone for over two years, and have not been able to notice the slightest deterioration, despite the fact that some of this powder was stored in 8-gauge, paper, shotgun shells, in which containers it had been shipped to Panama so that it would come under the express rating of loaded cartridges and not as powder. Unless it becomes actually wet I do not believe it will be affected at all by atmospheric changes. As a matter of fact if common sense is used in the storage of any bulk powder it will not be affected by moisture. Such powder stored in an open wood shed, or in a cellar cannot be expected to give normal results.

When bulk powders are loaded into fired shells that are dirty from previous firing, and the loaded cartridges are then not fired for a considerable length of time, they will gradually deteriorate. If fired at once, or within a month or two, no bad results will be noted. If the loaded ammunition is to be kept for a greater period care should be taken to clean and thoroughly dry the shells before loading. The best methods of cleaning fired shells are described in Chapter XIII.

DENSE POWDERS

Events moved fast with the powder makers in the '90s. The small-bore rifle shooting a light-weight, long, metal-jacketed bullet at high velocities was taken up by all governments. The sporting trade, falling into line, soon demanded rifles lighter in weight than those of .44-40 and .45-70 caliber that they had been regarding as the best. It was not enough to make these same rifles and cartridges smokeless. Powders of greater power or concentration were in order, so that the ammunition could be lightened and power increased. The manufacturers responded with a new, small-bore, high-power rifle, and a new type of smokeless powder occupying less shell space, and developing a much higher velocity. So these concentrated or high potential powders were soon known as condensed or "dense" powders.

The actual formulæ of different dense powders vary widely as has already been explained, but all American powders of this type have a similar appearance and structure. Their grains are of a hard, gelatinous, or celluloid material, moulded and formed in the shape of small tubes or perforated cylinders, and colored shiny black on the outside with graphite.

Dense powders vary widely in strength, so we must not get the idea that the term "dense" represents any set standard. The tendency is to produce powders more dense and concentrated than ever. However, this in itself is not always a desirable characteristic unless accompanied by other equally essential features. To illustrate, "Sharpshooter" powder, one of the older powders, is undoubtedly the most highly concentrated of all rifle powders, much more so than Du Pont No. 10. But Sharpshooter exerts its potential strength in a manner so inferior to No. 10 that with its maximum practical velocities of but 2000 feet per second are possible, while the velocities normally obtained with No. 10 are 3000 feet per second.

Dense powders possess undoubted points of superiority over the bulk brands. They are far more stable, are waterproof, are not affected by atmospheric conditions, permit the obtaining of higher velocities, and due to their peculiar grain construction and method of manufacture allow more perfect control in burning. As has been stated, all dense powders of American manufacture are made in a distinctive type of grain, resembling short lengths of small tubing. Some have grains resembling washers; that is, the length of grain is less than the diameter; others have grains longer than thick. The

perforations or holes through the center of the grains are usually about the size of a needle hole in the nitroglycerine brands, and smaller than this in the nitrocellulose powders. This peculiar shape of grain permits control of the rate of burning impossible of attainment by any other means. Where the bulk powder can burn from the outside to the center of grain only, the dense powder burns from both outside and inside surfaces. Varying the diameter and length of grain and the diameter of the perforation gives a large factor of control over the burning.

Modern dense powders are not handicapped by the limitations of the rifle as were the earlier bulk powders. Rifles are now constructed with much stronger breech actions. The barrels are now made of harder steel of high tensile strength and capable of standing high pressures. Pressures are now limited only by the strength of the brass cartridge case, which may be placed at a limit of 70,000 pounds in rifles having the ordinary commercial or military chamber, and 80,000 pounds in rifles constructed with perfectly fitting chambers and perfected firing pins designed for high pressures.

Dense powders, as previously noted, are divided into nitroglycerine and nitrocellulose types, and the latter type into regular and progressive burning types. Nitroglycerine powders are the older and are inferior to nitrocellulose for most purposes. Their chief fault lies in the high temperatures at which they burn, and their chief advantage in the even velocities which they give. Another serious fault is that they are not as stable as the more modern nitrocellulose powders, and this point is especially noticeable in Arctic and Tropical regions. They are also erratic when burning at pressures exceeding 43,000 to 45,000 pounds. Their good features are that in certain cartridges of medium power, when no effort is made to get very high velocities, they develop 1500 pounds lower pressure than with nitrocellulose powders used for equal velocities, and do this with one to one and one-half grains smaller charge. They also ignite a shade easier than the nitrocellulose brands. The greatest handicap under which nitroglycerine powders labor is the limit of velocities obtainable. I do not know of a cartridge loaded with a nitroglycerine powder that will develop more than 2100 or 2200 feet velocity without incurring pressures so high that erosion immediately becomes too serious to overlook. In this nitrocellulose powders demonstrate one great superiority, giving velocities of 3000 to 3200 feet per second at pressures of 55,000 to 60,000 pounds, and still give no great trouble

from erosion. The temperature developed at these extreme pressures is still far below that generated by nitroglycerine powders burning at a pressure of only 40,000 pounds.

The minor objections (they can hardly be termed faults) to nitro-cellulose powders are that they require slightly larger charges than nitroglycerine powders, and that the pressures run slightly higher in a few instances. In my opinion the cost of these increased charges is offset many times over by the saving in the wear on the rifle barrel, while the insignificant increase in pressures amounts to nothing with the nickel steel barrels and locking lugs of today. If one uses only the best of primers with these powders, like the United States Cartridge Co. No. 8, and the United States Government primer no trouble with ignition will be noticed. The newer types, the progressive powders, have all the good points of the type, but develop greatly increased velocities with no appreciable increase in pressures. In addition cleaning is easier when they are used, and there is less erosion. Take for example Du Pont No. 16 powder in the .32 Winchester special cartridge. A charge of 32.5 grains weight of powder gives a velocity of 2225 feet per second, with a pressure of less than 36,000 pounds, and the erosive effects are so small that the life of the barrel is practically limitless. There is no metal fouling, and cleaning is a very simple proposition if any of the powder solvent oils are used.

COMPRESSING SMOKELESS POWDERS

A warning spread broadcast in the early days of smokeless powder by the makers of bulk powders was, "Never compress a charge." So thoroughly was this doctrine impressed on the minds of riflemen that I hear it echoed from many sources today. A little explanation will clear up the situation, and show that in part the warning is sound, and in part it is false. Such clearing up is necessary because many of the charges recommended in the preceding chapter fill the shells so full that some compression is necessary to permit the bullets to be seated.

The facts are that the *actual compression* of smokeless powder, bulk and dense, does no harm. What did cause the trouble was that the soft grains of bulk powders crumbled to dust when kept under compression more than a few days by the bullets. Such dust burns at tremendously increased speed, and runs up the chamber pressure above the margin of safety. This "margin of safety" was not high in the days of .44-40, .38-56, and .45-70 black-powder rifles with

soft-steel barrels and lead bullets. A charge which does not overflow the shell, if tapped several times, should permit sufficient compression for seating the bullet without alarming increase in pressure. The majority of dense powders are so hard that the grains will not crumble even when retained under pressure for a long time, hence such powders may be loaded tightly in shells without any change resulting by reason of the packing. Compression does no harm to such powders as the entire series of the Du Pont military and improved military powders, the W. A. .30-caliber, HiVel, and others. Sharpshooter powder should never be compressed. These powders ignite and burn slowly at the start, allowing the bullet time to move from the shell before the height of the pressure wave is reached.

Here it is necessary to call attention to some exceptions to the general rule. In the beginning of this chapter it was pointed out that every powder was given certain special treatments to give it peculiar properties of its own. As a result, certain powders are rendered so quick and violent in action under conditions other than those for which they were designed, that they must have air space in the shell for safety. Sharpshooter is one such, Bull's-eye, Unique, Pistol Powder No. 3, Rifle Powder No. 75, and in some instances Lightning, are others. Some of these powders demand air space because of high potential strength and others because they burn exceedingly fast, reaching their maximum pressure in the chamber of the rifle. Caution must be exercised against compressing them, and it may be added that they give proper and normal results only when loaded with greater or less air space.

CHANGING BULLETS

There are many cartridges on the market which have much merit, but which were designed just before many of the more important recent improvements and advancements became settled facts. Owners of rifles for these cartridges continually manifest a desire to bring their shooting up to present standards, so far as possible, by modifications of powder charge and bullet. I will make no effort to discuss this almost limitless subject at length here, but will simply point out that powder and bullets correct for every American cartridge in common use today are mentioned and described in the preceding chapter, where the reader will find the proper charge for each bullet, together with the velocity and pressure generated. From the point of view of the powder used, care must be taken to select the powder

in each case that will burn completely at the pressure required to drive the bullet at the desired velocity. Great care must be taken to select a powder suited to the resistance offered by the exact bullet used. For instance, in the Krag rifle the regular 220-grain bullet gives more resistance, owing to long bearing surface and weight, and if the 150-grain bullet is used the powder must be the quick burning No. 21, No. 16, or No. 18, rather than the old standard W. A. which cannot possibly burn completely behind this bullet. Whenever a new bullet is to be loaded in any cartridge full attention should be given to all the factors involved, including weight, hardness, bearing surface, lubrication, and other points.

MEASURING MODERN RIFLE POWDERS

Owing to the shape and size of grain of many smokeless powders, they cannot be measured accurately enough for best, or even safe, results with scoops or the Ideal measure. Some, it is true, can be measured satisfactorily; others can be measured in light and medium charges, but should be weighed in maximum charges; while still others cannot be measured at all. In general, bulk powders can be measured, while dense powders should be weighed, though there are exceptions to this rule. It is pretty safe to say that no rifleman who loads dense powders can get satisfactory results without a pair of scales for use at least to check his measuring. Weighing always should be done when great accuracy is desired, when extreme velocities are to be obtained, and when the rifleman is experimenting; also for all coarse grained powders, although some finer ones can be measured.

The extent of the error or variation in charge that is permissible when ordinary pressures and velocities are obtained, is about one-half grain. This, however, forms a larger proportion of a small charge than of a large one, and may produce larger target errors. When high pressures and velocities are to be obtained the extent of the error should be limited to one-fifth of a grain, and such limitation calls for careful weighing. A variation of one-half grain in the powder charge of the .30-caliber, Model 1906 cartridge has been observed to cause an error of one inch per 100 yards of range, that is an error of ten inches at 1000 yards. The Ideal powder measure will permit of such an error with Du Pont No. 20 powder, hence ammunition with measured powder charges will be less accurate to this extent than ammunition with powder accurately hand weighed.

The equivalent table given in the next chapter comparing bulk

measure as measured with the Ideal measure with actual weight of the charge is as accurate as it can be made, but is subject to unavoidable errors. For instance, the stampings of the marks on the slides of the Ideal measure often vary slightly. Of fine grained powders in small loads, this table will enable a careful person to throw charges from the measure that will be accurate to within one-fourth grain. With the coarser grained dense powders the most careful setting of the measure in connection with the table cannot be depended upon to within 3 to 5 grains. It is impossible, except by chance, to set the measure successfully for the same charge twice. The Ideal measure, however, if set carefully and adjusted by checking with scales, will throw most powders accurately to within half a grain. The method of using this measure in connection with scales, and instructions for weighing powder with scales, are given in the next chapter.

Dip measures or scoops can be used with fair satisfaction for the bulk powders if handled carefully. If jarred, they must always receive a blow of exactly the same weight in the same direction. It is possible to vary the contents of a 40-grain scoop as much as five to ten grains simply by filling without jarring, or by jarring. Scoops and measures for smokeless powder should always be checked with scales. Any rifleman who does not own a pair of his own should request the nearest druggist to verify the measure he uses with the weight of the powder to be measured. Suitable scales for measuring powder are described in the next chapter.

The powders that should always be weighed are the Du Pont powders Nos. 10, 13, 15, 19, and 20, and Hercules HiVel. Pistol Powder No. 3, Bull's-eye, and other similar powders measure evenly once the measure is set for them, but they are so concentrated that a slight error in the charge is magnified, consequently the measure should be checked with scales frequently. Powders that can be measured with satisfaction are Du Pont Nos. 1, 75, 80, and Schuetzen. It will be noted that these powders are of the short grained, bulk type.

The Ideal measure slide screw will not hold the slides from movement with certainty. Charges therefore should be tested on scales every hundred rounds to detect movement and variation. To get some of the larger charges that are recommended in the foregoing chapter into their shells considerably more compacting can be obtained without compression by dropping the powder in from some

distance. A loading tube 6 to 12 inches long should be used for this purpose.

IDENTIFICATION OF POWDERS

It is best not to try to identify powders offhand by their appearance. To do so may result in trouble, and perhaps even in danger. The grains of some of the more modern powders are almost identical in shape and size, and even attempts to identify them by measurement of the grain by a micrometer caliper is by no means certain. It is best to depend on canister labels, and in order that no mistake may arise it has been my habit for some years always to paste a slip of blank paper over the label on a can as soon as I empty it, so that if I happen to use that can for powder again I will not make any mistake. It does not pay to take any chances with powder, and the rifleman should cultivate careful methods from the start when handling them.

It is possible to load double charges of powder in some shells without the error being observed. In some instances this will result only in wild shooting, with perhaps leading or metal fouling of the barrel. In other cases it will result in developing excessive pressures, and may even burst the rifle. Particular care should be taken in this connection when the following powders are used: Sharpshooter, Bull's-eye, Pistol No. 3, Unique, Lightning, and Du Pont No. 75.

POWDERS FOR REDUCED LOADS

In selecting a powder for a lighter load than the standard in any rifle and cartridge, the governing principles are to get a powder that burns completely within the barrel length at the required pressure, and that otherwise conforms to the laws as explained in previous pages. However, numerous special factors must be taken into consideration. For light loads, particularly in high power rifles, Du Pont No. 75 and 80 powders will prove the best in a majority of cases. For mid-range loads with gas-check or jacketed bullets the range of selection is wider, and includes Sharpshooter, Lightning, and Du Pont Nos. 80, 21, and 18, and possibly others. Accuracy is the prime requisite, and tests and experiments are the only means of learning about this. One rifle may handle a load that another will not. Barrels also vary.

Poor burning is to be avoided because it leaves unburned powder in the barrel, chamber, and action that will give fouling trouble and prevent the accurate seating of the cartridge. It is possible, how-

ever, in some cases to get accuracy from charges that do not burn completely. For instance Du Pont No. 18 powder in the .30-caliber, Model 1906 cartridge will not burn completely in charges of 20 to 25 grains, but will shoot with exceeding accuracy with proper bullets. Even No. 21 in charges of the same weight gives good results in this and similar cartridges.

When other things are equal, preference should be given to nitro-cellulose powders over nitroglycerine ones. Many claim that in reduced charges, and at less than extreme pressures, these powders do not erode barrels any more than those of milder type, but my personal experience does not lead to such conclusions. The powder charges recommended in the Ideal Handbook for short-range, reduced loads in high-power rifles are in the main correct, but in some instances those recommended for reduced charges are impracticable and inaccurate because too heavy for the bullets indicated. In the preceding chapter I have given many reduced charges for various cartridges that have been tried in a number of rifles for that cartridge and found satisfactory. In auto-loading rifle cartridges Sharpshooter and other similar powders are often loaded with compressed charges. Such loading is permissible and safe because the breech of an auto-loading rifle instantly blows back when the pressure mounts to a certain point. This is a feature of the normal functioning of such rifles.

SHORT AND LONG BARRELS

The length of barrel of the rifle, as has been pointed out from various angles, has much bearing on the shooting of its cartridge. This matter is not generally understood. For instance, the normal or standard velocity with the Krag rifle with its standard .30-40-220 cartridge is 2000 feet per second, the rifle having a 30-inch barrel. With the Krag carbine, the barrel of which is only 22 inches long, the velocity falls off 80 feet. The shortening of some barrels, notably the Ross .280, has even more effect than this. Such decrease in velocity means an increase in trajectory and bullet drop. More than this, it may be accompanied by other evils.

When the barrel length is shortened or lengthened, it is well to examine the powder charge to see if a change should not be made in it also to obtain the best results. Shortening the barrel may not only reduce the velocity, but the powder may fail to burn completely, and this may bring inaccuracy.

I once heard of a man who cut down the 28-inch barrel of a Ross .280 rifle to 22 inches, whereupon the standard .280 Ross cartridge, loaded with Du Pont No. 10 powder developed nowhere near the normal 3050 feet velocity, gave poor accuracy, and left much hard, unburned powder in the barrel and chamber. The use of a quicker burning powder, Du Pont No. 20, partly restored the velocity but not the accuracy. No. 15, however, almost completely restored both. Applying this same principle to the Krag again, the maximum velocity of which the .30-inch barrel is capable will probably be secured with Du Pont No. 16 powder, while the maximum velocity of which the 22-inch carbine barrel is capable will probably be secured with Du Pont No. 18. Many riflemen must face this condition in respect to other calibers, particularly those who use cartridges of the same caliber loaded for both revolver and rifle, and those who use short-barreled carbines. A carbine may perform very poorly with the usual commercial ammunition, but its shooting usually can be greatly improved by selecting the proper grade and amount of powder for its barrel length.

DIFFERENT LOTS OF THE SAME POWDER

Every powder user has noticed the manufacturers' references to "lots" of powder, and many may have noted that slightly varying charges of different lots are recommended. For instance, one lot of Du Pont No. 20 may give the standard muzzle velocity of 2700 feet in the .30-caliber, Model 1906 cartridge with a charge of 46 grains, and another may require 48 grains, while a third may give it with 44 grains. Smokeless powder is made in lots of the capacity of the equipment of the powder mill. Two thousand pounds used to be the average at the Du Pont works, but this has now been increased to take care of the necessary war output, to 50,000 pounds. Due to any one or more of a hundred variations that are possible in ingredients and in processes, two different lots may come out, showing slightly varying density or rate of burning. Each lot is tested by firing, and its actual performance in different rifles is made a matter of record. Within each lot variation is impossible, for all of every lot is blended, as the term goes, by spilling it from the top of high towers to piles below. The individual does not need to concern himself much about varying lots of powder, for the manufacturers sell to the trade only such lots as conform to the standard for that par-

ticular powder. Other lots are used by the cartridge loading companies who know how to allow for the difference in the density and burning.

DIFFERENT KINDS OF COMMERCIAL POWDERS

We now come to a consideration of each of the various kinds of powder commonly used in American rifles. On the following pages will be found a description of each kind of powder, its characteristics, and the uses to which it is best adapted.

DU PONT MILITARY RIFLE POWDER NO. 20

Also known as "1909 Military Powder" and "Government Pyro, .30 caliber D. G." This history-making rifle powder was the first



Fig. 77

Combination rifle and shotgun made for Hon. Theodore Roosevelt by Fred Adolph. Top barrel 20 gauge shotgun, lower barrel .25-35 W. C. F.

of the nitrocellulose type to give unquestioned satisfactory service. It was developed during 1908 and 1909 by E. I. du Pont de Nemours & Co. At that time nitroglycerine powders were standard in spite of their erosive properties, the nitrocellulose powders still being in a somewhat debatable stage, owing to the fact that no stabilizer had been introduced into their composition. The 1909 Military powder, as No. 20 was then called, showed American riflemen what an ideal powder should be, and started the demand for the still greater improvements that have been so abundantly met in the years since its introduction.

No. 20 is a dense nitrocellulose powder of the regular burning type, with shiny black tubular grains .085 inch long and .03 inch in diameter. It was developed specifically for use in the .30-caliber, Model 1906 cartridge to replace the unstable "Rose-aniline" pyro

powder of a pink color which the Government had been using in an effort to get away from the evils of nitroglycerine.

No. 20 is adapted for use in cartridges of .30 caliber and smaller, and even in some .35 and .40 caliber cartridges, notably the .405 W. C. F. It has a wide range of usefulness among both sporting and military cartridges of medium power and capacity. Its normal burning pressure is 45,000 to 50,000 pounds. It will burn fairly well at 55,000 pounds without developing much trouble, and at pressures considerably lower than 40,000 pounds in some cartridges, notably the steeply tapered bottle-neck class. The velocities developed in this powder primarily are those of the 2700 foot class with 150-grain bullet in the .30-caliber, Model 1906 cartridge. In doing this the powder is working under the exact conditions for which it was designed, and it works to best advantage. In many other cartridges, however, it develops their standard velocities in a very satisfactory manner, such as the 7 mm. Mauser, .25 Remington auto-loading, and .22 high-power Savage.

No. 20 is in the same series as Du Pont No. 10 and No. 21, occupying a position midway between them as to burning speed. All three powders are of the same composition, and differ only in size of grain. As soon as No. 20 reached the general market it displaced nitroglycerine powders entirely among careful riflemen who loaded their own ammunition, and of course entirely displaced the original and inferior nitrocellulose without stabilizer, the manufacture of which has been discontinued. It educated riflemen to the advantages of nitrocellulose powders and started them to demand it, and it also taught powdermakers how to proceed to secure the variety of excellent powders that have since been brought out.

An advantage of No. 20 is that it develops extreme accuracy at 2700 feet velocity with 150-grain bullet in the Springfield and Enfield rifles. Before this powder was brought out no such accuracy was known. It is not suited for securing the increased velocities over the standard that are now possible with the progressive burning powders. While it can be measured by the Ideal powder measure and otherwise, charges should be weighed where great accuracy is desired. The variation in weight of charge secured by measuring are not great enough to cause serious inaccuracy, nor to develop pressures lower or higher than permissible limits for good and safe results. It burns at a low temperature, ignites readily, and leaves a residue that is easily removed with proper solvents. Reduced charges

cannot be loaded with No. 20, nor can any but metal jacketed bullets be used with it.

DU PONT MILITARY RIFLE POWDER NO. 21

After Du Pont No. 20 powder proved to be so successful in the .30-caliber, Model 1906 cartridge, and other cartridges of a similar nature, there was a great demand for a nitrocellulose powder that would burn at the proper rate for small-bore sporting cartridges of limited shell capacity like the .30-30, .32 Special, and .25-35. This demand was brought to a head by the introduction of the .22 Savage High Power cartridge and rifle, in the firing of which barrels some-



Fig. 78

Double barreled elephant rifle with German telescope sight, made by Fred Adolph

times lasted only about 300 rounds before the bore was badly eroded when nitroglycerine powders were used.

No. 21 is a dense nitrocellulose powder of the regular burning type with the usual tubular, perforated, black, graphited grains .04 inch long and .03 inch thick. In composition it is identical with No. 20 and No. 10, but is the quickest burning of the three, therefore it will burn at lower pressures than the others. It was developed during 1913, and put on the general market in 1914. This powder has a very wide range. Its best burning takes place at 36,000 to 41,000 pounds pressure to the square inch, but it will burn with fair satisfaction at higher and lower pressures. It develops standard velocities in all the 2000 foot seconds cartridges, including the .25-35, .30-30, .303 Savage, and .32 Special, gives 2800 feet velocity in the .22 Savage High Power, and 3000 feet in the .250-3000 Savage cartridge. In

addition it may be used in emergencies in the .30-caliber, Model 1906 cartridge, the .30-40 cartridge, and others of similar size and power, and it may be used with considerable satisfaction for mid-range loads behind gas-check or metal-cased bullets giving 1400 to 2000 feet velocity. For the latter purpose it provides a nitrocellulose substitute for the erosive nitroglycerine powders formerly recommended, though in such loading is perhaps not always quite as good as the Du Pont No. 18.

The advantages of No. 21 are that it gives great accuracy, is easy to clean, burns at low temperature, measures so well in the Ideal measure that while weighing is still an advantage charges can be secured by measuring with much satisfaction. It is the most flexible of the regular burning nitrocellulose powders, that is to say, it can be used with a greater range of pressures, and it may be used in the greatest number of cartridges.

No. 21 greatly resembles No. 18 in grain appearance, hence care is necessary to avoid getting the two mixed. This is doubly important because the charges of each powder are by no means the same for identical cartridges. Those using No. 21 should confine themselves to the standard velocities. To increase charges is to invite trouble, and besides it is unnecessary because where a quick burning powder is needed to give ultra-high velocities Du Pont No. 18 will work better.

DU PONT MILITARY RIFLE POWDER NO. 10

When the Ross Rifle Company of Quebec developed the .280 cartridge they found that its resulting velocity was limited by the nature of the burning of all powders then available. The shell is of very large capacity, and is steeply bottle-necked, both factors making for intensity of burning of powder in full charges. What was needed was slower burning powder possessing the non-erosive and other good qualities of Du Pont No. 20. Accordingly No. 10 was developed specially for the .280 Ross cartridge, and results at once justified the effort. Velocities up to 3100 feet at the muzzle were secured with the 143-grain bullet, and 2700 feet with the 180-grain bullet. So accurate was the new powder that the list of matches it won stands today almost unrivaled.

No. 10 is a dense nitrocellulose powder of the regular burning type with tubular granulation .12 inch long by .033 inch thick. It will be noted that these grains are half again as long as those of the Du Pont No. 20 powder. They are the longest grains made in any

nitrocellulose powder intended for rifles. The composition of No. 10 is the same as that of Nos. 20 and 21, with which it forms a series, occupying the position of the slowest burning. In fact it is the slowest burning of all dense powders. It was in 1910 that this powder was first manufactured, but not until 1912 was it placed on the market in cans. The pressures required to burn it properly are 52,000 to 57,000 pounds. It will not burn properly at lower pressure, although it will stand considerably higher ones without trouble. Its use, therefore, is restricted to the most modern of cartridges and rifles which develop and safely stand pressures up to 60,000 pounds. Until the introduction of the Newton series of cartridges, the .280 Ross was the only cartridge in which it could be used with success. In the .256 Newton it has proved to give good results, developing a velocity of about 2850 feet. It may also be used in the .30 Newton cartridge.

No. 10 should always be loaded by weight because the grains are too large to pass through any measure with accuracy. Only metal-jacketed bullets can be used with it. I do not look for this powder to remain in general use much longer. Whatever is required of it can be done better by the modern progressive powders such as the Du Pont Nos. 13 and 15. These powders develop the same velocity as No. 10 with less pressure, or higher velocities with equal pressure.

DU PONT IMPROVED MILITARY RIFLE POWDER NO. 15

This was the first of the new series of powders put on the market — the first progressive burning, smokeless, rifle powder — and it was this powder which opened the eyes of riflemen all over the world to the possibilities of improvement along the lines of increasing bullet velocities without increasing pressures.

No. 15 is a dense, progressive burning, nitrocellulose powder, with the usual black tubular grain, measuring .085 inch long by .035 inch in diameter. It looks very much like Du Pont No. 20, although the grains are slightly thicker. Its resemblance to other members of the progressive burning series is even closer, and riflemen should be careful to avoid confusing it with them should it become separated from its regular canister.

It was issued to the trade in the autumn of 1914, but did not become generally known until 1915. Its origin is very interesting. A special experimental cartridge was designed for a foreign government, with new features from primer to bullet. None of the existing powders were

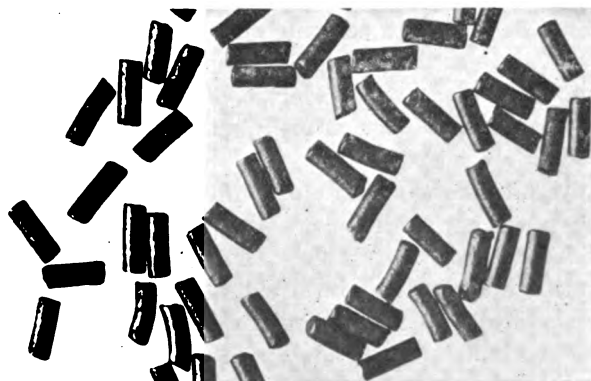
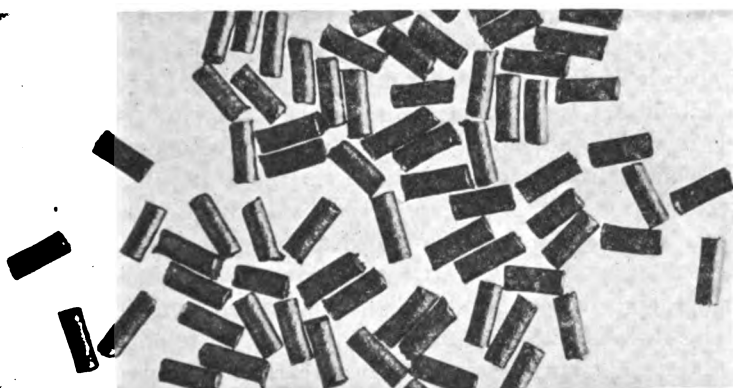
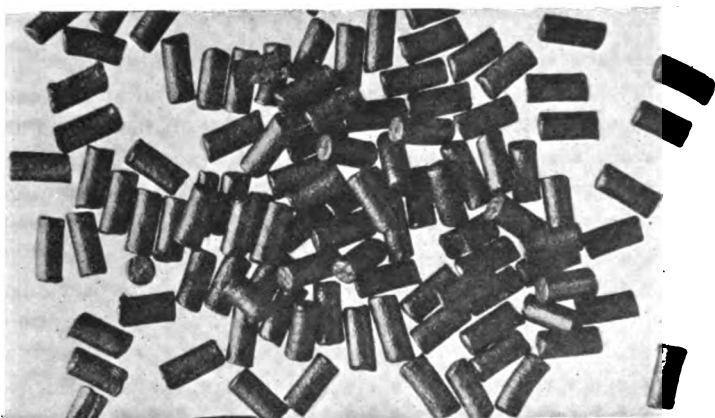

Fig. 75

Grains of modern rifle powders, greatly enlarged

1. Du Pont Improved Military Rifle Powder No. 13
2. Du Pont Improved Military Rifle Powder No. 15
3. Du Pont Improved Military Rifle Powder No. 16

considered satisfactory for use in it since they could not be expected to give results superior to those which they gave in well known cartridges, hence a new powder with hitherto unknown qualities was required. The cartridge was of .30-caliber with a shell resembling the .30-caliber Model 1906, and carried a pointed bullet weighing 180 grains. The rifle barrel was 30 inches long. This cartridge with the new powder that was designed for it proved to give a velocity of 2800 feet at the muzzle, with a pressure of 55,000 pounds. The best previous similar result achieved in a practical way was about 2500 feet muzzle velocity in the .30-caliber, Model 1906 cartridge with similar pressure. At once the new powder was tried in various older cartridges, with the results that the now famous 2925 foot muzzle velocity load with this powder was found to be just as practical as the regular standard load.

No. 15 is adapted for use in all cartridges of .30 caliber or smaller which use shells of large powder capacity, and does its best work with pointed bullets. Its burning pressure is 50,000 to 55,000 pounds, though it will stand more than this without becoming erratic. Its chief advantage is that in a number of cartridges it will develop 100 to 300 feet more velocity than can be obtained with the regular burning powders. In relation to other powders No. 15 occupies a position which in a sense is midway between Du Pont No. 13 and Du Pont No. 16, though both these latter are slightly improved in their composition. It practically takes the place of both Du Pont No. 10 and Du Pont No. 20 of the regular burning types. In all cartridges and rifles to which its nature is suited it gives the usual nitrocellulose accuracy. No. 15 cannot be measured accurately and charges must be weighed. Its disadvantages are that the weight of charge, and hence expense, is a little more than with some older powders, that it ignites a little harder, it gives a big muzzle flash at night, and it can be used only in a limited number of cartridges.

The recoil it produces is quite different from that given by regular burning powders. It does not seem to be less in amount, but is exerted in a different direction. It also seems to give a different flip to the barrel, and sight elevations with it will be found considerably below those obtained with regular burning powders in equivalent loads. Only metal-cased bullets can be used with No. 15, and only full charges of powder. It burns too slow for use in reduced loads.

DU PONT IMPROVED MILITARY RIFLE POWDER NO. 18

When Du Pont No. 15 powder had demonstrated the possibilities of a progressive burning smokeless powder by giving more than 2900 feet velocity in the .30-caliber, Model 1906 cartridge, a call immediately arose for a similar powder that would burn correctly in cartridges of more limited powder capacity. No. 15 burns so slowly that it can be used only where the charge is big, especially in the smaller bores. This second progressive burning nitrocellulose powder was therefore developed in 1915, and first marketed during the latter months of that year. The grains are .045 inch long and .03 inch in diameter (a very short cut), and of course are of the usual tubular shape. In the size of grain No. 18 greatly resembles the regular burning No. 21 powder, and it is intended to replace that excellent one in many cartridges. In designing No. 18 the makers had in mind particularly the requirements of such cartridges as the .25-35 and .30-30. It is in these and similar cartridges, therefore, where the best results from its use may be expected. It burns best at pressures from 33,000 to 38,000 pounds.

After numerous tests of No. 18 had been made it proved to have a great deal more flexibility than either No. 21 or No. 15. At pressures of 45,000 and even 50,000 pounds it does not become erratic, while at pressures as low as 20,000 pounds it still burns in a fairly satisfactory manner. This enlarges the field of its usefulness so as to take in the .30-40 cartridge, and it can even be used in the .30-caliber, Model 1906 cartridge. It is also suitable for reduced loads, and can be used with gas-check bullets.

The velocities developed with No. 18 are 100 to 350 feet higher than standard in a big range of medium hunting cartridges. As related to other powders, it is the quickest burning progressive powder that we have. The special advantages of No. 18 are the quick burning (good in small shells and short barrels), the accuracy that it gives, the low temperature at which it burns, and consequent absence of erosive action in the bore, the wide range of cartridges in which it may be used, possibility of using it in reduced loads, and the accuracy possible in measured charges. Weighing is useful as a check, but the Ideal measure will throw charges very close to what is required, especially for the lighter loads.

The limitations of No. 18 are that care must be exercised when the charges used are close to the maximum. On account of its quick burning, abuse of it by overloading may cause very high pressures, which,

though regular, may still be dangerous in some of the older hunting rifles. Attempts should not be made to use it steadily in place of the slower burning progressives in cartridges of the .30-40 class and larger. Larger proportionate charges of No. 18 may be used in shells of slight or long taper, and in larger bores than in cartridges where the opposite pertains.

DU PONT IMPROVED MILITARY RIFLE POWDER NO. 16

The history of all other progressive powders is involved in the making of this one, and in it is comprised all progress along this line that so far has been taught the makers. It is the latest, most modern progressive rifle powder. Perhaps from its performances we may get some idea of what may be expected of the rifle powders of the future.

No. 16 in type is a progressive burning nitrocellulose powder with almost the same size grains as No. 15, though slightly less in diameter. It was first put on the market early in 1917, though a preliminary lot was distributed among expert riflemen during 1916. This time the manufacturers worked to perfect a progressive powder suited to a wide range of cartridges and conditions, rather than to one particular cartridge or type of cartridge. As a result No. 16 is the most flexible dense powder, if not the most flexible of all modern powders, and more nearly approaches the universal powder than any made since black powder days.

Its best burning pressure lies between 30,000 and 50,000 pounds, though within these limits no one seems to have established a point at which it does better than at others. In consequence of these capacities No. 16 is suited to a wide range of cartridges and rifles, from .22 Savage high power, through the various .30 calibers, to the .405 Winchester. It has also been officially adopted as the powder for small arms by the British war office. Many of the cartridges in which it does good work, on account of being straight shells or for other reasons, never before have been able to use a dense powder with more than fair satisfaction.

The velocities that can be developed in all these cartridges with No. 16 are the highest ever known. For instance 3250 feet can be obtained in the .250-3000 Savage cartridge, and 3000 feet in the Springfield with 150-grain bullet. Standard velocities can be secured, if desired, by reducing the charge without any trouble resulting. All of these loads develop accuracy equal to any on record. No. 16 in

relation to other powders of its type, stands between the quick burning No. 18, and the slow burning No. 13. In respect to No. 15 it is quicker.

Its advantages, summed up, are that it is extremely accurate, burns at very low temperature, ignites easily, and is very widely useful. It can be used to speed up and transform many otherwise inefficient cartridges. A feature not to be overlooked is that its residue seems to clean out of barrels easier than that of any other smokeless powder. This feature is so marked that every one using the powder has noted it. Lack of erosive properties, with this lack of corrosive nature of the residue, permit barrels to be fired more than 20,000 rounds with No. 16 without their accuracy having deteriorated enough to be serious. In fact this powder causes only about 60 per cent. of the erosion caused by even as cool burning a powder as No. 20. No. 16 measures



Fig. 79

Krag rifle remodelled into a sporting arm by Fred Adolph

fairly well. In charges intended to give standard velocities the Ideal powder measure can be relied upon to throw them with sufficient exactness and uniformity for ordinary work if the setting of the measure is checked by the scales. When charges giving extreme velocity are used each charge should be weighed.

DU PONT IMPROVED MILITARY RIFLE POWDER NO. 13

Although No. 13 is not generally on the market at the time this is being written, yet I want to include a description because no other powder can be used to secure equal results in the .256 Newton cartridge, and in some similar cartridges. This powder was developed during 1917, and properly can be said to be an outgrowth of No. 16 powder. It has about the same composition, and is intended to take up where that powder leaves off.

No. 13 is a dense, nitrocellulose, progressive burning powder, with tubular grains about .08 inch long and .04 inch in diameter. The grains vary much in measurement, owing to their drying crooked, and

to edges turned and flared. In appearance No. 13 greatly resembles No. 15.

The history of No. 13 is a story of numerous experiments with No. 10, and No. 15 in the Newton series of cartridges, and incidentally in the Ross .280. The peculiar conditions to be met included a required ultra high velocity in each case, a very large charge of powder in a big shell with sharply restricted neck and small bore. The powder needed should be of the progressive burning type, and should burn slower than No. 16. The burning of No. 13, designed with these conditions in view, is normal between 50,000 and 55,000 pounds. It will burn satisfactorily at higher pressure, but not at much lower. With normal pressures velocities of 2975 feet per second are obtained in the .256 Newton rifle with 24-inch barrel, upwards of 3300 feet in the .280 Ross with 28-inch barrel, and 3225 feet in the .30 Newton with .30-inch barrel. To bring out more clearly the capacities and limitations of No. 13, certain peculiarities of these results should be noted. The .256 Newton has a smaller powder capacity than the other two cartridges named, hence must use a smaller charge. Increasing the barrel length of this rifle to 30 inches brings no appreciable increase in velocity, proving that the entire charge burns in the 24-inch barrel. In the .280 Ross a 24-inch barrel with maximum charge of No. 13 that can be put in this big shell, gives only about 2990 feet, while in a 28-inch barrel the same charge gives 3300 feet velocity. This shows that the larger charge is required for best burning under .280 conditions, and that longer barrels than 24 inches are required to realize the full potential force.

No. 13 is one of the powder series which includes Nos. 15, 18, and 16, but is more closely related to the latter powder than the others. It is the slowest burning of the four. It differs from No. 16, however, in being restricted in usefulness to the few cartridges of large powder capacity such as those above described. The grains are a little too coarse for uniformity in measuring. This, in connection with the fact that all the charges are maximum ones, makes the weighing of each charge imperative. No. 13 should not be used in an effort to secure lower than standard velocities, since the charge required would be considerably less than the maximum, and the pressure far lower, hence poor burning would surely result with consequent falling off in accuracy and other troubles.

HERCULES W. A. .30-CALIBER POWDER

What 1909 military powder did in assisting the development of the Springfield rifle between 1906 and 1909, this .30-caliber powder did in even greater degree for the Krag rifle between 1900 and 1904. The fact that it is obsolete now should not detract from the credit due it for its good work in past days.

W. A. is a dense, 30 per cent., nitroglycerine powder with grains about .08 inch in diameter by .04 to .05 inch long. They are perforated, forming thick washers in shape, are graphited, and are gray-black in color.

The .30-40 Krag cartridge when it first came out was loaded with a special black powder experimentally, but the excessive fouling proved this powder impracticable. Then it was loaded with various foreign cordite powders, and finally with Peyton smokeless, but all these powders were not perforated, nor were they graphited. Their burning temperature was excessively high, their pressures were erratic and uncontrollable, and they gave generally inaccurate results.

The W. A. powder, so named from the two chemists who developed it, Mr. Whistler and Mr. Aspinwall, was graphited and perforated, and immediately gave results not before approached in the .30-40 cartridge for which it was designed. It at once replaced the older powders. During the first two years of its use it was badly handicapped by inferior bullets, and not until 1903 when proper bullets of at least .308 inch in diameter were made for the .30-40 Krag cartridge did this powder begin to show its real possibilities. From then on until 1907 it won all the international rifle matches, and it remained the best dense smokeless powder until the introduction of stable nitrocellulose powder during the period between 1906 and 1909.

The correct burning pressure of W. A. is 34,000 to 39,000 pounds to the square inch. Below these pressures it burns incompletely and erratically; above them it reacts strongly to the pressures and increases excessively in temperature of burning. At its normal pressures it develops muzzle velocities of about 2000 feet in the .30-40 Krag cartridge with the standard 220-grain bullet. It is not suitable for use with any of the lighter bullets in this cartridge, nor for others without metal jackets or with less bearing surface, nor with charges that vary much from the Krag standard. It can be used, however, in several other cartridges similar to the Krag, such as the .33 W. C. F., and .35 W. C. F. Model 1895, with long, heavy bullets, and with shells of about the same powder capacity.

W. A. in series is one of four nitroglycerine powders that have been widely used, the other three being Lightning, Sharpshooter, and HiVel. Of these it is quicker burning than HiVel, but slower than the other two. Its place in the development of modern rifle powders is that of the pioneer, and its purposes today are better served in the .30-40 as well as other cartridges by the more modern nitrocellulose powders.

The advantage of W. A. was that it was accurate in long barrels with heavy bullets. A low weight of charge was required. Viewed



Fig. 80

Double barrelled elephant rifle made by Fred Adolph

from the present day angle, W. A. is inflexible (can be used in a few cartridges and with no variation in loading), it burns hot and erodes the barrel seriously, develops only a low velocity, and is not capable of giving the accuracy of the more modern powders. Krag rifles fired with nothing but W. A. begin to show inaccuracies that can be noticed by an expert rifleman after about 1000 rounds have been fired from them, and the accuracy is seriously impaired after about 1700 rounds.

HERCULES LIGHTNING POWDER

This is a dense powder of wide usefulness, and with but one bad fault — its hot burning and erosive effect on the barrels. It is of the nitroglycerine type, containing 30 per cent. of that explosive, and is

made in two grain sizes called No. 1 and No. 2. As the grains come from the dies they are cut .1 inch in diameter by .015 inch long for No. 2, and .08 inch in diameter by .05 inch long for No. 1. In drying these grains contract a little, and warp much, so that the grains of the powder on the market vary greatly. These grains are of the perforated tube variety but are cut so short that they resemble washers rather than tubes.

The correct burning pressure for Lightning is 32,000 to 37,000 pounds per square inch. It was designed about 1903 in answer to a demand for a dense smokeless powder that would make possible high-power, hunting cartridges somewhat smaller than the .30-40 Krag, such as the .30-30, .303 Savage, and .25-35. In this type of cartridges it developed velocities about 2000 feet per second. Later on experiments showed that it was excellent for cartridges of the .30-40, 7 mm. and 8 mm. class when they were loaded with lighter bullets. Still later Lightning proved extremely useful for mid-range loads in all high power cartridges, when used with either metal-jacketed bullets, or alloy bullets with copper gas-checks on the base to protect the base of the bullet from being fused by the hot powder gases.

The advantages of Lightning are clean burning, great accuracy, more than fair stability except under extremes of heat and cold, light weight of charges required, and good measuring quality. The Ideal measure cuts a few grains, but throws charges with pretty satisfactory exactness. It develops standard velocities in the .30-30 and similar cartridges with slightly lower pressure than the equivalent charge of nitrocellulose powder.

The disadvantages are, first, the hot, eroding gases generated. Any rifle using this powder for a thousand shots is bound to show typical erosion or washing away of the lands just in front of the chamber. Lightning reacts quickly to slight overloading, as well as to heat. Thus if forced to burn behind a cartridge that normally would require a pressure of say, 40,000 to 50,000 pounds, the nature of the powder is such that the pressures might run up to 60,000 to 70,000 pounds, or even more, which would be dangerous. When ammunition is loaded with Lightning for use in the tropics, a few grains should always be deducted from the regular charge. Great care should be exercised by any one loading Lightning to check the powder measure with scales whenever the charges used pass the mid-range amount, or when heavier or harder bullets than the standard are used.

In series, Lightning classes with Sharpshooter, the quicker burning

nitroglycerine powder, and with W. A. and HiVel, both slower burners. In development it belongs strictly to the nitroglycerine period, and any results that it gives are duplicated or excelled by the proper nitrocellulose powder of more modern introduction. Today there is little more justification for loading .22 Savage High-Power, .30-30, .303 Savage, .32 Special, and other such cartridges with Lightning, than there is in loading the .30-caliber, Model 1906 cartridge with HiVel, when No. 20 and the newer powders are available. Lightning is far better suited for mid-range charges, where pressure is minimum, than for full power charges.

HERCULES SHARPSHOOTER POWDER

This powder was introduced to give modern smokeless powder results in a diversified group of cartridges in which W. A. and Lightning would not burn properly. In some of them it achieved excellent velocities; in others little improvement over the black powder standards was obtained.

Sharpshooter is a dense, nitroglycerine type of powder, with two sizes of grain, measuring about .08 inch in diameter by .01 and .015 inch thick, respectively. It will be noticed that this is a very fine powder which burns at great speed. It contains 40 per cent. of nitroglycerine, which, together with the quick burning, makes it the most virulent eroding powder manufactured. The grains are graphited and perforated, hence look like black washers. The date of introduction was about 1903. The manufacturers probably had the conditions of the .45-70 cartridge as much in mind as those of any other when they formulated Sharpshooter, but it was intended for use in all cartridges which gave little bullet or neck resistance. Quick burning was one essential, ease of complete ignition another. In consequence Sharpshooter burns well, and gives accurate results in .45-70, .38-55, .32-40, .38-40 and many other such cartridges. The burning pressure required is 26,000 to 31,000 pounds. It will not burn well at much below this pressure, and above it it becomes very erratic and dangerous. It has been much recommended for reduced loads in high power rifles, even in .22 Savage High Power, and .250-3000 Savage. In such loading it gives accurate results, but it is so destructive that its advantages are entirely outweighed. It is the powder considered best for automatic rifles, particularly those of the blow-back type of action. During recent years several of the cartridge loading cartridges have used it extensively in the so called "High Velocity, Low Pressure" car-

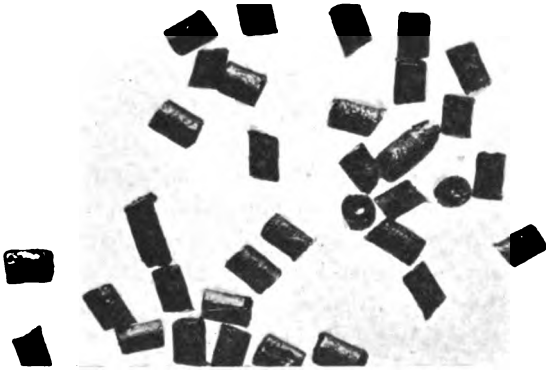

Fig. 75A

Grains of modern rifle powders, greatly enlarged

1. Du Pont Military Rifle Powder No. 21
2. Du Pont No. 1 Rifle Smokeless
3. Du Pont Sporting Rifle Powder No. 80

tridges for rifles of the black-powder class, and for the real high-velocity ammunition of the same size cartridges. It is not the proper powder for the latter.

The velocities developed with the usual Sharpshooter loading are the standard for black powder. The High Velocity loading gives 1600 to 1970 feet at the muzzle, varying with different cartridges and bullets. In general the powder is not suitable for developing more than standard black-powder velocities, owing to excessive reaction to slight increase in pressure, and to excessively hot burning.

In series Sharpshooter classes with W. A., Lightning, and HiVel, and is the quickest burning of the four. In development it is years behind any nitrocellulose powder. If its manufacture were to cease its place could be filled by other existing powders without any loss whatever except for the gap between the quick burning No. 80, and the slower burning No. 18. At this point there is room for another nitrocellulose powder.

The advantages of Sharpshooter are so many that one cannot help wishing that it did not have such serious faults. It is highly concentrated and takes a low weight of charge. It is impervious to moisture from the air. It is extremely accurate. It burns well in straight shells, and develops the maximum effect from the minimum of shell space. In short, when used without regard to erosion it is a valuable powder. This erosion, however, is most serious in small bores and least serious in large bores. It shows very little erosion in the .45-70 rifle. In very small rifles, like the .25-20, it causes other troubles probably from an intensely acid residue which occurs in these small bores where the powder charge does not so fully dilute the extremely acid product from the combustion of the primer. The charges measure out very uniformly in the Ideal powder measure or otherwise, but in anything like full loads for any cartridge they should be checked by weighing to assure against overloading. Caution is necessary in attempting to identify Sharpshooter by the appearance of the grains alone, as there is very little difference in appearance between it and the smaller cut of Lightning, and a charge of the latter which would be correct would be a heavy overload for Sharpshooter.

HERCULES HIVELE POWDER

This is also known as Du Pont Military Rifle Powder No. 19, and as "1908 Military." It was formerly made by the Du Pont Company, but they have now discontinued its manufacture, and the Her-

cules Powder Company are the only firm manufacturing it at the present time. It is a special powder formulated for the .30-caliber, Model 1903, and .30-caliber, Model 1906 cartridges, in which it failed to give complete satisfaction because of its erosive qualities.

HiVel is a dense nitroglycerine powder, with 15 per cent. of that explosive. The grains measure about .09-inch in diameter by about .05 inch long, and are perforated and graphited. It is the most recent addition to the series comprising Lightning, Sharpshooter, and W. A., and the slowest burning of the four. It never was widely used, although a few military target riflemen preferred it because of its extreme accuracy in the .30-caliber, Model 1906 cartridge, particularly with the 180-grain bullet.

HiVel was developed in 1908 under the name of "1908 Military Powder," to fill a demand for a slower burning powder than W. A. for use in the .30-caliber, Model 1906 cartridge. In that year the efforts of the Du Pont Company to produce a suitable powder for this new cartridge were conducted along both nitroglycerine and nitrocellulose lines at the same time, with the result that the nitroglycerine 1908 powder was first produced, to be quickly followed and entirely displaced by the 1909 Military of nitrocellulose type, the name of which has since been changed to Du Pont No. 20.

HiVel burns best at a pressure of 42,000 to 47,000 pounds. It develops standard velocities in a few cartridges having fairly large powder capacity, such as the .30 Model 1903, .30 Model 1906, .35 Winchester Model 1895, .33 Winchester, and a few others, but is not suitable for getting increased velocities owing to the extreme erosion developed. Its accuracy is splendid, although no better than the proper loads of nitrocellulose powders. Long-range riflemen used to use it with great success by changing the barrels of their rifles after every 500 rounds or so. When loaded to give standard velocities it develops from 1000 to 1500 pounds less pressure than the corresponding regular burning nitrocellulose powders. It ignites easily and uniformly, and the residue is easily cleaned from the bore.

The charges should always be weighed. It will not measure uniformly in the Ideal powder measure or otherwise. I should like to caution any rifleman against attempting to use this powder in any of the ultra high-velocity cartridges such as the Newton series, and the .280 Ross, since any charge that will develop normal velocities in these arms, or even burn the powder properly behind their bullets, will impair the barrels through erosion in a very few rounds.

DU PONT NO. 1 RIFLE SMOKELESS POWDER

This was the first bulk smokeless rifle powder produced in America, and is still widely used. It has numerous good qualities, and no serious faults. Its shortcomings are those of lack of capacity. No. 1 is a true bulk-for-bulk nitrocellulose powder with fibrous, irregular

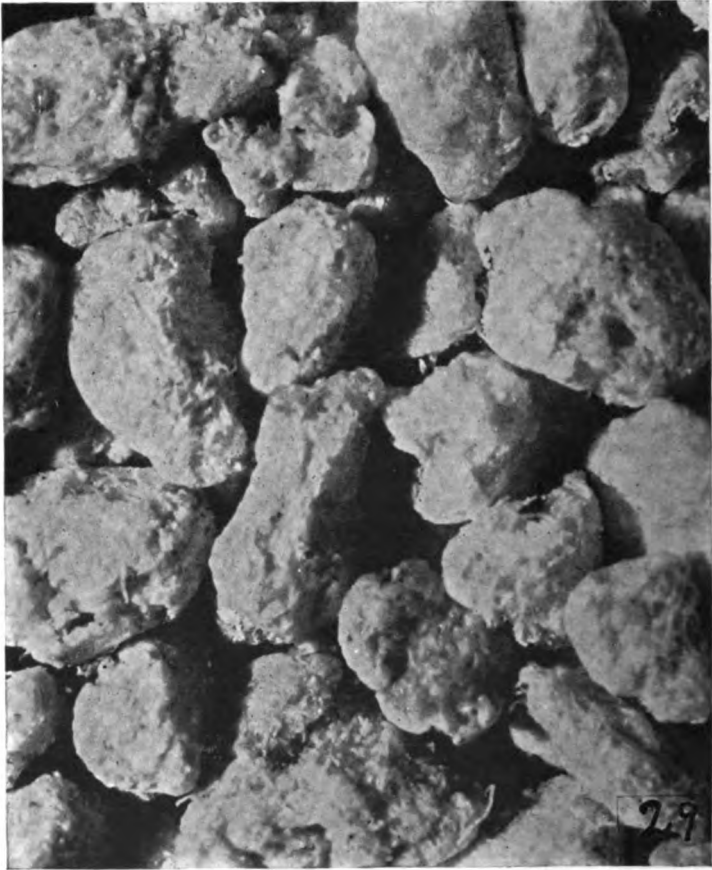

Fig. 76

Du Pont No. 1 Rifle Smokeless. Four hundred times actual size

grains screened through a 16-to-the-inch mesh, and caught on a 26-to-the-inch mesh, which makes it a rather coarse granulation. The color is slightly smoky or dirty white. It was developed about 1898 and was designed for replacing black powder in the then long list of black-

powder cartridges ranging from .25 caliber up to .50 caliber. It was successful in these cartridges, and during later years to some extent also in reduced charges for high-power rifles. The burning pressure is 20,000 to 25,000 pounds. The velocities developed by No. 1 are those which are standard for black powder. It gives no increase. The aim of the designers was to get a clean burning, smokeless powder that would occupy the same powder space as the regular black-powder charges. Increasing the charge gives slight increase in velocities, but brings certain troubles which make the effort not worth while.

No. 1 was produced before No. 75, which is of a somewhat similar composition, and long before No. 80, which, using many of the same ingredients, is more condensed, quicker burning, and more moisture resisting.

The one outstanding advantage of No. 1 at the time that it was introduced was the smokeless feature. A hunter could fire shot after shot from a repeating rifle without the smoke obscuring his game as it would do with black powder. It could be used in a great many cartridges, gave excellent accuracy, burned at a low temperature, measured well, and used a low weight of charge. Against these advantages was the necessity for a tighter fitting bullet than with black powder, for smokeless powder cleaning, and for special smokeless primers.

A caution necessary in the use of No. 1 is that charges compressed in the shell should be fired within a few days after loading. If left longer the soft grains will crumble under the bullet pressure, and in this fine condition the powder will burn much faster, and develop pressures much higher than normal. The powder in cans and in the cartridges after loading, with any sized charges, should be protected from moist air, as the grains absorb moisture readily.

DU PONT SCHUETZEN POWDER

This is a true "bulk-for-bulk," smokeless rifle powder, in that charges for any cartridge occupy the same shell space as charges of black powder. It is of a nitrocellulose composition, with large grains of a light reddish brown color resembling very fine gravel. In the manufacture the grains are screened through a 15-to-the-inch mesh, and caught on a 25-mesh screen.

Schuetzen was issued to the trade in 1909, and was designed specially for fine target shooting in Schuetzen rifles of .32-40 and .38-55 caliber. It burns at a pressure of 22,000 to 26,000 pounds to the square

inch, and develops approximately the same velocities as black powder. No other powder is more accurate than this when it is loaded under the conditions intended, and especially when the bullet is seated in the rifling ahead of the shell, or in the breech-muzzle loading rifles. Schuetzen burns coolly, and its residue is easily cleaned from the bore, though smokeless powder methods are required. It measures with the greatest accuracy so that there is little advantage in weighing the charges. Its use is limited to the two cartridges named, and to a few others with straight shells. I have found it excellent in the .25-20 single-shot cartridge with metal-jacketed bullet. It should be used only in full charges as it burns too slowly for reduced loads. It is also too much subject to moisture absorption, and to effects from dirt in the shells, for satisfactory use in loaded cartridges that are to be kept some time before firing. For almost all purposes, except Schuetzen shooting on the range, No. 80 is a better powder.

DU PONT GALLERY RIFLE POWDER NO. 75

This powder was formerly known as "Marksman." In many respects it has been, and still is, one of the most important and valuable of our modern rifle powders. It never has brought about entire re-designing of rifles, as No. 20 has done, but it has served exceedingly well to make a great many otherwise highly specialized rifles more widely useful.

No. 75 is a nitrocellulose powder classed as "bulk," though it is considerably more concentrated than the true "bulk-for-bulk," smokeless powders. The grains are fibrous, irregular in shape and size, with all the corners rounded off to make them flow more freely and easily in powder measures. They are of a size that goes through the 26-to-the-inch mesh screen, but not through the 60 mesh, which makes a fine grained powder. The color is steel gray. This powder was designed about 1904 for the .30-40 Krag rifle in reduced charges. The Army and Navy at that time had encountered difficulties in accomplishing the desired amount of target practice with full service ammunition, and no suitable powder was available that could be used with success for loading or reloading these cartridges with an economical charge good for ranges up to or beyond 200 yards. The Laffin and Rand Powder Company then designed this powder, making it of a nature to ignite and burn properly when loaded in small charges in large shells, and to do this without fusing the base of the bullets, which were of lead alloy.

Experiments soon showed that "Marksman," as it was then called, worked equally well in a wide range of cartridges, notably the .25-20, .25-35, .30-30, and .30 Model 1906, and later on in the .22 Savage High Power, .250-3000 Savage, .280 Ross, and even in the Newton series of cartridges. In all these cartridges, however, it fills just the one purpose, that of giving bullet velocities of from 800 to 1600 feet. Naturally it is less useful in the small cartridges than in the larger ones because it closely approximates standard results in the small ones.

The burning pressure is 10,000 to 15,000 pounds. It will burn with fair satisfaction in proper rifles at 5000 pounds less than the average of these figures, and at several thousand higher. In the .30-40, for instance, with a bullet weighing 175 grains, a charge of about 11 grains will give a velocity of about 1200 feet, which for target purposes reproduces the .32-40 black-powder cartridge. I have used 15 grains in the .30-40, and 17 grains in the .30 Model 1906 cartridges, both with the 150-grain, pointed, full-jacketed, service bullet, with excellent results and the finest accuracy. These loads must develop 1600 to 1700 feet velocity.

No. 80 is a somewhat similar powder, though of a different composition, and slightly less concentrated. No. 1 differs still more, and is much less concentrated. Of these three it is the quickest burning.

The advantages of No. 75 are that in proper charges it does not fuse alloy or lead bullets, it is very accurate, requires a low weight of charge, has no eroding effect on the barrel, cleans out easily, measures with great uniformity in the Ideal measure, and ignites well even when the charge occupies only a small part of the shell space. The disadvantages are that it is susceptible to moisture, and cannot be used for full charges to get standard velocities. Riflemen should load their reduced charges with No. 75 not very long before using them, and should clean their shells. Loaded ammunition left in shells, especially if the shells are dirty inside, is liable to deteriorate in such a way as to become inaccurate at least. No. 75 should not be used in extremely light charges for gallery ammunition, nor in charges of its own class where No. 80 is indicated on account of its resistance to moisture.

DU PONT SPORTING RIFLE POWDER NO. 80

For a long time after No. 1 was developed no advance was made in the bulk class of powders, with the result that certain nitroglycerine brands, such as Sharpshooter, came into general use in black-powder cartridges. No. 80 is a bulk nitrocellulose which was developed in 1914

to take this place. The grains are fibrous, irregular in shape, and are screened through a 24-to-the-inch mesh, and caught on a 56 mesh, and are buff in color. No. 80 was designed for use in all the older class of low-power rifles in which black powder could be used, and works well with plain lead, gas-check, and metal-jacketed bullets. After it had been on the market for some time experiments showed that it gave excellent results in revolver and automatic pistol cartridges, and in automatic rifle cartridges. It also proved to be very serviceable and accurate in reduced charges in high-power cartridges for all sizes from .22 Savage High Power up to .30 Newton and .405 Winchester.

The correct burning pressure is 14,000 to 19,000 pounds, but it will burn with fair satisfaction at much lower pressures. At higher pressures it reacts to some extent, and develops a temporary excess of pressure near the head of the shell. The velocities developed are anything desired within a few hundred feet of the standard for black powder. Thus it will give lower velocities with reduced loading, standard velocities with charges as recommended on the canister, and with larger charges, will give the "high velocities" required in the .38-40, .44-40, .32-40, and .38-55 cartridges of that designation. It develops all the velocity that gas check bullets will stand, and can be substituted for Sharpshooter with advantage in all medium and small sized shells at least.

No. 80 burns slower than No. 75, and faster than No. 1. In point of development it is a long way ahead of either of these, and should replace them in all loading except that of No. 75 behind plain, lead-alloy bullets. The advantages of No. 80 are great accuracy, easily removed residue, ease of measuring (there is no necessity of weighing charges), ease of ignition, great flexibility (it will work well in almost all cartridges), resistance to moisture absorption and the effects of dirt in shells, and cool burning. It ignites readily even when the charge used occupies only a small part of the shell space. It can be loaded into dirty shells without deteriorating within a short time. Its cool burning prevents the fusing of lead bullets, and prevents damage to rifle barrels.

Certain disadvantages, however, must be guarded against. While it is classed as bulk powder, it cannot be loaded bulk-for-bulk with black powder. The correct charge is stated below for each cartridge in so many grains, and this bulk can be secured with the Ideal measure or otherwise by the use of the equivalent table given in the next chapter. In many cases the recommended charges practically fill the shell, and in

a few cases must be jarred or tamped to permit the seating of the bullet. Compression apparently does no harm, but should be avoided if the charge can be gotten in the shell by jarring.

The following is a list of charges of No. 80, giving standard velocities in the cartridges stated:

Cartridge	Bullet, grains	Weight of charge, grains
.22-13 Winchester S. S.	45 lead	4.3
.22-15 Stevens	60 lead	6.
.25-20 Repeater	86 lead	7.
.25-20 Single Shot	86 lead	6.8
.25-21 Stevens S. S.	86 lead	7.5
.25-21 Stevens S. S.	86 jacketed	8.8
.25-25 Stevens S. S.	86 jacketed	9.
.25-25 Stevens S. S.	86 lead	8.
.32-20 Winchester	100 lead	8.6
.32-20 Winchester H. V.	100 jacketed	12.
.32-40 Winchester	165 jacketed	13.2
.38-40 Winchester	180 jacketed	14.9
.38-55 Winchester	255 jacketed	16.4
.44-40 Winchester	200 jacketed	17.
.44-40 Winchester	200 lead	15.7
.45-70 Winchester H. V.	300 jacketed	31.
.45-90 Winchester	300 jacketed	31.2
.45-90 Winchester	300 lead	29.7

FOR USE IN REVOLVERS

.32-20	100 lead	7.5
.38-40	180 lead	16.3
.44-40	200 lead	18.2

When used in large charges, a limit is reached in each cartridge past which the head pressure in the chamber becomes too much for the shell, expanding and tightening it, though the chamber and barrel pressures may be lower than normal for the velocity developed. Riflemen should load up to this limit, but not beyond it. For instance, in the .45-70 cartridge with the 330-grain bullet of nearly pure lead, a charge of 28 grains will upset the head of the shell, while one of 26 grains does not.

CHAPTER XIII

RELOADING AMMUNITION

WHEN a center-fire cartridge is fired in a rifle there remains the case or shell, almost as good as new, and worth practically half the cost of the cartridge; that is, to say from one to three cents. Primers, powder, and bullets can be purchased, and this shell can be reloaded many times with a resultant great reduction in one's ammunition bill. From an economical standpoint it of course depends upon how one wishes to spend one's spare time, and how much one's time is worth.

In a great many cases the rifleman will find that reloaded ammunition is more satisfactory than the factory product, because it is possible for him to vary it slightly to suit exactly the peculiarities of his own rifle, and also because he can make up special loads that are not handled by the factories. The factory must manufacture a certain cartridge so that it will fit every rifle of that caliber, and this cartridge must be perfectly safe in all these rifles, despite rusted barrels and worn actions. The rifleman can use the shells which have been fired in his own rifle and fully expanded to fit the chamber perfectly, this in itself contributing to better accuracy. He can use a bullet which just fits to the bottom of the grooves in his particular barrel, and if he so desires, and his rifle is in A 1 condition he can load the cartridge a little heavier than the factory loads and still have a plentiful margin of safety, although in this latter respect he *must* have a knowledge of powders and pressures, and know exactly what he is doing.

An acquaintance with thousands of riflemen throughout our country enables me to assert that very few of them load their own ammunition. Considering the advantages which accrue from the proper reloading of ammunition, the several reasons for this should be considered. First, American factory ammunition loaded by any of our four largest ammunition factories, Winchester, U. M. C., United States, and Peters, is so good that it really cannot be adversely criticised. Considering that the factory must cater to *every* rifle, and *every* rifleman, it is impossible for them to do better. Factory ammunition in an accurate, well-designed rifle will shoot better than the rifleman can hold

nine times out of ten. Second, the hunter and sportsman fires comparatively few shots, and his yearly ammunition bill is not a serious item. Third, the military rifle shot fires probably ten times as much ammunition yearly as any other class of shooters, but his ammunition is usually largely provided by the Government. Fourth, a great number of riflemen have tried reloading and given it up as unsatisfactory, principally, I think, because they have failed to obtain and use properly *all* the tools necessary, and because they have adopted needlessly complicated methods. For example, muzzle resizing chambers, shell-expanding chambers, and powder measures are always sold by the manufacturers of reloading tools as "extras." In fact some manufacturers do not make them at all. As a matter of fact they should not be advertised as extras, and a set of tools should never be sold without them because they are an absolutely essential part of the equipment if satisfactory reloading is to be accomplished. Similarly, if bullets are to be moulded, a mould alone will not suffice; a dipper, and a lubricating and sizing machine are essential. Where one tries to economize, or through lack of knowledge buys less than a complete outfit, he is doomed to failure.

It is to the rifle crank that reloading will especially appeal. He will find that he will be able to produce more accurate target ammunition, more powerful hunting ammunition, and find reduced loads for his high-power rifles, none of which he can purchase ready loaded from the factories. His yearly ammunition bill will be just about cut in half. Moreover, he will learn lessons in ballistics, and acquire an intimate knowledge of his weapon which can hardly be attained if he confines himself to factory ammunition. Reloading ammunition certainly pays in every way, and it is therefore intended to give herein detail methods by which absolutely satisfactory results can be attained.

We will describe first the simplest case of reloading, that is where one takes shells which have been fired in his rifle and reloads them with smokeless powder and a jacketed bullet, the bullet being purchased ready made. We will say that we have on hand 100 empty shells which have been fired in our rifle, and we wish to reload them. Let us also say that our rifle is a United States magazine rifle, Model of 1903, using the .30-caliber, Model 1906 cartridge, and that we wish to reload the shells with a load particularly suited to big game shooting. First, we must have certain tools and materials as an initial outlay. One will need the following tools:

- 1 Ideal No. 10 special reloading tool with double adjustable chamber for the .30-caliber model 1906 cartridge.
- 1 muzzle resizer for above tool to resize the necks of the shells so that they are slightly below .308-inch diameter inside.
- 1 shell expander chamber for above tool to expand the inside of the neck of the shell to just .308 inch.
- 1 Ideal universal powder measure No. 5, with drop tube for .30 caliber up.

He will also require the following materials:

Primers, either U. M. C. No. 9, United States Cartridge Co. No. 8, or the United States Government standard service rifle primer. Best purchased in lots of 1000.

Several cans, holding one pound each, of Du Pont military rifle powder No. 15. One hundred or more 180-grain, 30-caliber umbrella, metal-cased, pointed bullets manufactured by the Remington Arms-U. M. C. Co.

We are now ready to proceed as follows: First we will assume that the fired shells have been well taken care of, that they have not been allowed to get wet or dirty, that they have not been injured or mashed out of shape, and that they are not so old that they have become corroded inside. We must now decap, or remove the old fired primers from these shells. Screw the double adjustable chamber into the handle of the reloading tool, and insert in the chamber the primer extracting plug which comes with the tool. Screw up, or unscrew, the chamber in the tool until the needle in the point of the plug comes only about $\frac{1}{50}$ inch above the surface of the tool; that is, the surface inside the jaws of the tool. Now remove the plug from the tool, and insert it point first in a shell, taking care that the needle enters the flash hole at the base of the shell inside. One can feel it enter here, and soon acquires dexterity in getting it in the hole instantly each time. It is of course essential that it enter the hole, because if it does not it will not eject the old primer, and if one closes the tool with the needle not in the flash hole the needle will probably be broken or bent. Now holding the plug in the shell, insert both in the chamber of the tool and close the handle and press gently. No effort is required. The old primer will be forced out of the shell. Extract the primers from all the shells, then rub the plug off with an oily cloth, and put it away.

The shells when fired in the rifle have been so expanded at the neck that they will not hold the bullet's friction tight as is necessary. Consequently they must be resized at the neck. Now all brass rifle shells are drawn in manufacture, not turned on a lathe. As a consequence they are not of equal thickness, nor is one particular shell of equal thickness on all sides. It follows that if we simply decrease their diameter at the neck by forcing each into a die we will get uniform diameter outside, but not inside, where we desire it in order to have each bullet securely and uniformly held in the shell. It is therefore

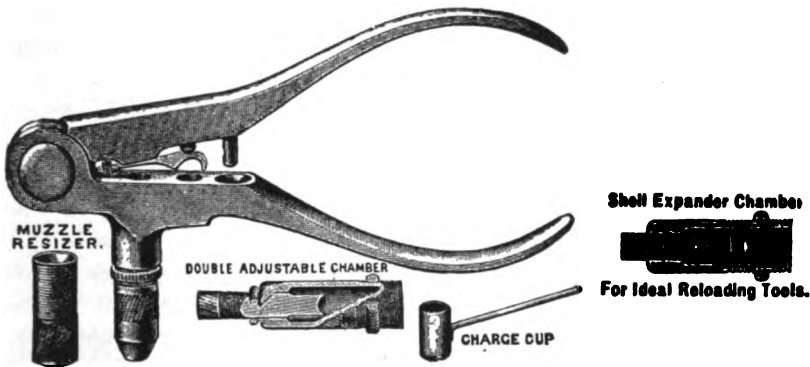

Fig. 81

Ideal tools required for efficient reloading

necessary first to force the neck of each shell into the muzzle resizer so as to decrease its diameter *inside* below that required, and then expand each shell inside by forcing it into the shell expander chamber so that each shall have a uniform diameter inside the neck. The bullet which we are using is .30825 inch in diameter, and if we enlarge the resized shell to .308 inch inside the neck we will have just the correct size to hold the bullet friction tight in the shell. As a dry shell is liable to stick in the muzzle resizer, we first go over all our shells and wipe them off with a *slightly* oily rag. Do not use too much oil, just enough to make the shell look shiny without appearing oily. Next, remove the double adjustable chamber from the reloading tool and insert in its place the muzzle resizer. Screw the muzzle resizer up gradually, trying a shell in it until you find that the shell is resized just up to the shoulder at the base of the neck but no further. No particular effort should be required to close the handles of the tool, just a firm pressure, but a little tug will usually be found necessary to open the handles. This resizes the necks of the shells so that they are slightly under .308 inch inside. Next, remove the muzzle resizer and insert the shell-expander chamber in its place. Insert a shell and close the handle, so adjusting the plug inside the chamber that when the tool is closed the plug passes through, or almost through, the neck of the shell into the enlarged portion of the shell inside. Then run all the shells through this chamber, expanding them to an accurate .308 inch inside. During this process it may be necessary to unscrew the expander plug entirely out of the chamber occasionally, and wipe it off with the oily rag to prevent the shells sticking unduly.

Next we have to insert new primers in the shells. Take the top of a cardboard box and empty about 100 primers into it, as they are much easier picked up in such a container than in the original box. Insert a shell in the priming hole in the reloading tool, which is the hole just alongside the one which the various chambers screw into. Take a primer in the fingers and lay it on top of the primer pocket of the shell. Gently close the tool so that the primer inserting plug rests on the primer. Easily, and without undue force, complete the closing of the tool until the primer is forced to the bottom of the primer pocket. Take particular pains that it is forced *clear to the bottom* of the pocket, as, if it is not, a missfire may result with that particular cartridge. No particular effort is required to insert and seat the primer, one will acquire considerable skill at it in a minute or two. Treat all the shells in this manner.

Now we come to the operation of loading the powder into the shells. First of all, if you are smoking, quit it. Do not have any fire around. Take a time when you will not be disturbed by other people, and keep your wits about you. When you once get started the principal things you must look out for are getting two charges of powder in one shell, or overlooking a shell and not getting any powder in it, and also seeing that no grains of powder are spilled, but that the entire charge gets in the shell.

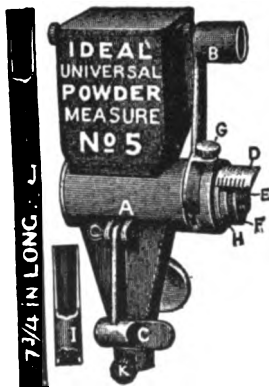

Fig. 82
Ideal universal powder
measure No. 5

First, you must adjust your powder measure to throw the charge desired. The powder measure is graduated for grains of BLACK POWDER, not smokeless. Every smokeless powder has its own particular bulk in relation to its weight. When we speak of grains of smokeless powder we always mean GRAINS BY WEIGHT. The table given herewith shows how the powder measure should be set to throw a certain weight of all makes of smokeless powder. The powder measure should be very carefully set according to the table, and in the manner set forth in the directions which accompany the measure. In this case we will say that we wish to load in our .30-caliber, Model

1906 shell 51.5 grains by weight of Du Pont military rifle powder No. 15, which will give to the 180-grain bullet a velocity of 2651 feet per second measured at a range of 78 feet, which approximates a muzzle

velocity of 2700 feet per second. The breech pressure will be about 56,000 pounds to the square inch. Referring to the table we will see that in order that the powder measure shall throw 51.5 grains of Du Pont No. 15 powder it must be set at 58 grains, black-powder measure. After you have set the measure in this manner go all over the calculation from start to finish again, checking it up. YOU CANNOT BE TOO CAREFUL IN THIS, A GRAIN OR TWO OVER WOULD GIVE YOU DANGEROUS PRESSURES.

It is easiest to work with the powder measure clamped to a standard or small shelf so that the end of the tube shall come four or five inches above the table or bench. The shells should be arranged on the bench in regular order, ten in a row to the left of the end of the tube, muzzle up. Now open a can of powder, and fill the reservoir of the measure almost to the top. Thereafter fill it up every few minutes so as to always keep it over half full. Take a shell with the left hand, place the muzzle under and against the opening of the loading tube,

COMPARATIVE TABLE OF WEIGHT AND BULK OF "DUPONT IMPROVED MILITARY RIFLE POWDER NO. 16" WITH BLACK POWDER

This table does not compare the strength of Du Pont improved military rifle powder No. 16 with black powder, but is given here to enable shooters using the Ideal universal powder measure to have handy a table for setting same when loading this powder. By setting the measure slide at the proper figure in the left-hand column, the desired charge of improved military rifle powder No. 16, shown in the right hand column, will be thrown in actual grains weight.

Set measure at	Weight charge desired		Set measure at	Weight charge desired
20	17		36	30.4
22	18.6		38	32.2
24	20.6	"DE"	40	33.9
26	22.3	Slides	42	35.5
28	23.8		44	37.3
30	25.3		46	39.2
32	27.0		48	40.8
34	28.7		50	42.7
36	28.6		60	54.1
35	32.7		65	59
40	37.9	"DEF"	70	64
45	41.3	Slides	75	68.6
50	46		80	73.2
55	50			

Note: Du Pont improved military rifle powder No. 13 will not measure accurately through powder measures. This powder should always be weighed.

and turn down the handle, thus emptying the charge from the measure into the shell. Holding the shell there, give the little knocker on the front of the measure one little flick upward so that it strikes the upper

TABLE COMPARING THE WEIGHT (BY GRAINS) OF BULK MEASURE OF BLACK POWDER, WITH THE WEIGHT OF THE SAME BULK MEASURE OF SMOKELESS POWDERS

These tables do not compare the relative strength of Black with Smokeless Powders. The figures in the first column are the graduations of the Measures which are for grains' weight Black Powder only. The other columns are comparative weights for same bulk measure.

To Use the Measure: First, in the column for the powder you wish to use, select the particular load in grains' weight you desire; then set the measure at the graduation in column No. 1 opposite this weight.

The figures in this table were obtained, using powders furnished by the respective powder manufacturers for this purpose, by actually throwing charges of the different Smokeless Powders and weighing same upon very sensitive scales. While there may be some very slight variations in measuring different batches of the same powder, these figures serve as a reliable guide and are correct for all practical purposes.

When setting a powder measure it is always well to verify the charges thrown upon an apothecaries' scale. After the Universal Powder Measures are properly set for a given charge, they throw successive charges very accurately. The table has been submitted to the powder manufacturers for approval.

The number in front of the different powders designates the column in the table for that powder.

NAMES OF POWDERS

- 1 Graduations on measures and for black powder only.
- 2 No. 1 Rifle (Du Pont).
- 2 Schuetzen (Du Pont).
- 2 E. C. (Hercules).
- 3 Du Pont Gallery Rifle No. 75.
- 4 Unique (Hercules).
- 5 Sharpshooter (Hercules).
- 6 Lightning (Hercules).
- 7 W. A. 30 cal. (Hercules).
- 7 King's Semi-Smokeless.
- 8 Du Pont Military Rifle No. 20.
- 9 Ballistite (Du Pont).
- 10 Empire (Du Pont).
- 10 Schultze (Du Pont).
- 10 Smokeless Shotgun (Du Pont).
- 10 Mullerite.
- 10 Dead Shot.
- 11 Infalible (Hercules).
- 12 Bull's-eye (Hercules) (disc form).
- 12 R. S. Q. (Du Pont).
- 13 Du Pont Military Rifle Powder No. 21.
- 14 King's Smokeless Rifle Nos. 2, 3, and 4.
- 15 King's Smokeless Shotgun.
- 15 Robin Hood.
- 16 Du Pont Sporting Rifle Powder No. 80.
- 17 Walsrode H. P. Military.
- 18 Walsrode for Black Powder Rifles.
- 19 Walsrode Green.
- 20 Walsrode Gray.
- 21 Wolf.
- 22 Du Pont Military Rifle No. 10.
- 23 Du Pont Military Rifle No. 19.
- 23 HiVeL Rifle (Hercules).
- 24 Du Pont Military Rifle Powder No. 18.
- 25 Du Pont Military Rifle Powder No. 15.

No.	1	2	3	4	5	6	7	8	9	10	11	12	13	14	15	16	17	18	19	20	21	22	23	24	25
Grains
2 equals
3 equals
4 equals
5 equals
6 equals
7 equals
8 equals
9 equals
10 equals
11 equals
12 equals
13 equals

D & M SLIDES

D. F. SLIDES

No. 1	2	3	4	5	6	7	8	9	10	11	12	13	14	15	16	17	18	19	20	21	22	23	24	25
14 equals	Grs. 5.5	Grs. 6.	Grs. 6.5	Grs. 8.5	Grs. 9.5	Grs. 9.5	Grs. 9.	Grs. 7.5	Grs. 5.5	Grs. 7.	Grs. 7.7	Grs. 7.	Grs. 8.	Grs. 8.	Grs. 8.2	Grs. 8.	Grs. 5.	Grs. 10.5	Grs. 9.5	Grs. 5.	Grs. 10.5	Grs. 10.5	Grs. 10.5	Grs. 10.5
15 equals	Grs. 6.5	Grs. 6.5	Grs. 7.	Grs. 9.	Grs. 10.	Grs. 10.	Grs. 9.5	Grs. 8.	Grs. 6.	Grs. 7.5	Grs. 8.3	Grs. 8.	Grs. 7.5	Grs. 8.5	Grs. 8.8	Grs. 8.5	Grs. 5.5	Grs. 11.5	Grs. 10.5	Grs. 5.5	Grs. 11.5	Grs. 10.5	Grs. 10.5	Grs. 10.5
10 equals	Grs. 4.5	Grs. 4.	Grs. 5.5	Grs. 7.	Grs. 7.5	Grs. 8.	Grs. 7.5	Grs. 6.	Grs. 4.	Grs. 5.5	Grs. 6.	Grs. 6.5	Grs. 7.	Grs. 7.5	Grs. 7.5	Grs. 7.5	Grs. 6.5	Grs. 9.	Grs. 8.	Grs. 4.	Grs. 7.2	Grs. 8.1	Grs. 10.	Grs. 7.2
12 equals	Grs. 6.5	Grs. 5.5	Grs. 6.	Grs. 8.5	Grs. 9.	Grs. 9.5	Grs. 9.	Grs. 7.5	Grs. 5.5	Grs. 8.	Grs. 11.3	Grs. 9.7	Grs. 7.5	Grs. 8.5	Grs. 7.9	Grs. 8.5	Grs. 6.5	Grs. 10.5	Grs. 9.5	Grs. 4.5	Grs. 10.4	Grs. 10.	Grs. 10.	Grs. 8.7
14 equals	Grs. 6.5	Grs. 6.	Grs. 7.7	Grs. 10.5	Grs. 12.5	Grs. 13.	Grs. 12.	Grs. 10.	Grs. 10.	Grs. 11.3	Grs. 12.5	Grs. 10.	Grs. 10.	Grs. 10.	Grs. 9.1	Grs. 11.	Grs. 9.	Grs. 13.5	Grs. 10.5	Grs. 4.5	Grs. 10.4	Grs. 12.2	Grs. 12.2	Grs. 10.6
16 equals	Grs. 8.	Grs. 6.5	Grs. 8.8	Grs. 11.5	Grs. 14.	Grs. 14.5	Grs. 14.	Grs. 11.	Grs. 7.5	Grs. 10.5	Grs. 14.1	Grs. 11.5	Grs. 11.	Grs. 10.1	Grs. 12.5	Grs. 12.	Grs. 7.	Grs. 13.5	Grs. 12.2	Grs. 7.	Grs. 13.8	Grs. 13.2	Grs. 13.2	Grs. 14.2
20 equals	Grs. 9.	Grs. 8.5	Grs. 11.	Grs. 14.	Grs. 15.5	Grs. 16.5	Grs. 15.5	Grs. 12.5	Grs. 8.5	Grs. 12.5	Grs. 16.3	Grs. 12.5	Grs. 12.5	Grs. 11.5	Grs. 14.	Grs. 14.	Grs. 12.	Grs. 15.5	Grs. 13.5	Grs. 7.5	Grs. 15.5	Grs. 17.2	Grs. 17.8	Grs. 15.9
22 equals	Grs. 10.	Grs. 9.5	Grs. 12.2	Grs. 15.5	Grs. 17.5	Grs. 17.5	Grs. 14.	Grs. 9.	Grs. 12.5	Grs. 14.5	Grs. 18.1	Grs. 14.5	Grs. 13.5	Grs. 12.7	Grs. 15.5	Grs. 12.	Grs. 16.5	Grs. 15.5	Grs. 8.5	Grs. 16.2	Grs. 18.7	Grs. 18.7	Grs. 17.8	Grs. 17.9
24 equals	Grs. 11.	Grs. 10.5	Grs. 13.4	Grs. 17.5	Grs. 18.5	Grs. 19.5	Grs. 18.5	Grs. 15.	Grs. 10.	Grs. 14.5	Grs. 19.8	Grs. 15.5	Grs. 13.7	Grs. 16.5	Grs. 13.	Grs. 18.5	Grs. 16.5	Grs. 18.5	Grs. 9.5	Grs. 17.5	Grs. 19.5	Grs. 20.9	Grs. 21.4	Grs. 19.4
26 equals	Grs. 11.5	Grs. 11.	Grs. 14.6	Grs. 18.5	Grs. 20.5	Grs. 21.	Grs. 20.5	Grs. 16.5	Grs. 11.	Grs. 15.	Grs. 20.8	Grs. 16.5	Grs. 16.5	Grs. 14.8	Grs. 18.	Grs. 14.	Grs. 19.5	Grs. 17.5	Grs. 10.	Grs. 17.5	Grs. 19.5	Grs. 21.4	Grs. 23.3	Grs. 21.0
28 equals	Grs. 12.5	Grs. 13.	Grs. 15.8	Grs. 20.	Grs. 22.	Grs. 23.	Grs. 21.5	Grs. 17.5	Grs. 12.	Grs. 16.5	Grs. 22.4	Grs. 18.	Grs. 17.5	Grs. 15.9	Grs. 19.5	Grs. 18.	Grs. 20.5	Grs. 19.5	Grs. 10.5	Grs. 21.1	Grs. 24.1	Grs. 24.1	Grs. 23.3	Grs. 21.0
30 equals	Grs. 13.5	Grs. 14.	Grs. 17.1	Grs. 21.5	Grs. 23.5	Grs. 24.5	Grs. 23.5	Grs. 17.5	Grs. 12.5	Grs. 17.5	Grs. 24.2	Grs. 19.5	Grs. 20.	Grs. 16.3	Grs. 22.5	Grs. 17.	Grs. 22.2	Grs. 20.5	Grs. 11.5	Grs. 22.8	Grs. 26.6	Grs. 26.6	Grs. 25.3	Grs. 24.4
32 equals	Grs. 14.5	Grs. 14.5	Grs. 18.1	Grs. 23.5	Grs. 25.5	Grs. 26.5	Grs. 25.5	Grs. 18.5	Grs. 13.5	Grs. 18.5	Grs. 25.7	Grs. 21.	Grs. 20.	Grs. 16.3	Grs. 22.5	Grs. 17.	Grs. 23.5	Grs. 21.5	Grs. 12.5	Grs. 24.8	Grs. 28.6	Grs. 28.6	Grs. 27.1	Grs. 26.2
34 equals	Grs. 15.5	Grs. 15.5	Grs. 19.2	Grs. 24.5	Grs. 26.5	Grs. 27.5	Grs. 26.5	Grs. 19.5	Grs. 14.5	Grs. 20.5	Grs. 27.3	Grs. 23.5	Grs. 22.5	Grs. 17.5	Grs. 23.5	Grs. 18.	Grs. 25.5	Grs. 23.5	Grs. 13.5	Grs. 25.7	Grs. 29.8	Grs. 29.8	Grs. 28.4	Grs. 27.5
36 equals	Grs. 16.5	Grs. 16.5	Grs. 20.3	Grs. 25.5	Grs. 27.5	Grs. 28.5	Grs. 27.5	Grs. 21.	Grs. 15.5	Grs. 21.5	Grs. 28.6	Grs. 24.5	Grs. 23.5	Grs. 18.5	Grs. 24.5	Grs. 19.	Grs. 28.5	Grs. 26.5	Grs. 14.5	Grs. 30.4	Grs. 34.7	Grs. 34.7	Grs. 33.1	Grs. 32.2
38 equals	Grs. 17.5	Grs. 17.5	Grs. 21.4	Grs. 27.5	Grs. 29.5	Grs. 30.5	Grs. 29.5	Grs. 22.	Grs. 16.5	Grs. 22.5	Grs. 30.6	Grs. 26.5	Grs. 25.5	Grs. 20.5	Grs. 26.5	Grs. 20.	Grs. 30.5	Grs. 28.5	Grs. 15.5	Grs. 31.3	Grs. 35.8	Grs. 35.8	Grs. 34.2	Grs. 33.5
40 equals	Grs. 18.5	Grs. 18.5	Grs. 22.5	Grs. 28.5	Grs. 30.5	Grs. 31.5	Grs. 30.5	Grs. 23.	Grs. 17.5	Grs. 23.5	Grs. 32.4	Grs. 28.5	Grs. 27.5	Grs. 22.5	Grs. 27.5	Grs. 21.	Grs. 31.5	Grs. 29.5	Grs. 16.5	Grs. 32.5	Grs. 36.1	Grs. 36.1	Grs. 34.5	Grs. 33.7
42 equals	Grs. 19.	Grs. 19.5	Grs. 24.7	Grs. 31.5	Grs. 33.5	Grs. 34.5	Grs. 33.5	Grs. 24.	Grs. 18.5	Grs. 24.5	Grs. 33.9	Grs. 29.5	Grs. 28.5	Grs. 23.5	Grs. 29.5	Grs. 22.	Grs. 31.5	Grs. 30.5	Grs. 17.5	Grs. 33.5	Grs. 37.8	Grs. 37.8	Grs. 35.9	Grs. 35.4
44 equals	Grs. 20.	Grs. 20.5	Grs. 25.9	Grs. 32.5	Grs. 34.5	Grs. 35.5	Grs. 34.5	Grs. 25.	Grs. 19.5	Grs. 25.5	Grs. 35.9	Grs. 31.5	Grs. 30.5	Grs. 24.5	Grs. 30.5	Grs. 23.	Grs. 32.5	Grs. 30.5	Grs. 18.	Grs. 34.5	Grs. 39.8	Grs. 39.8	Grs. 37.9	Grs. 37.1
46 equals	Grs. 21.	Grs. 21.5	Grs. 27.1	Grs. 33.5	Grs. 35.5	Grs. 36.5	Grs. 35.5	Grs. 26.	Grs. 20.5	Grs. 26.5	Grs. 37.3	Grs. 33.5	Grs. 32.5	Grs. 25.5	Grs. 32.5	Grs. 24.	Grs. 34.5	Grs. 32.5	Grs. 19.5	Grs. 36.5	Grs. 41.4	Grs. 41.4	Grs. 39.3	Grs. 38.6
48 equals	Grs. 22.	Grs. 22.5	Grs. 28.9	Grs. 34.5	Grs. 36.5	Grs. 37.5	Grs. 36.5	Grs. 27.	Grs. 21.5	Grs. 27.5	Grs. 39.3	Grs. 35.5	Grs. 34.5	Grs. 26.5	Grs. 33.5	Grs. 25.	Grs. 35.5	Grs. 33.5	Grs. 20.5	Grs. 38.5	Grs. 43.6	Grs. 43.6	Grs. 41.6	Grs. 40.5
50 equals	Grs. 23.	Grs. 23.5	Grs. 29.5	Grs. 35.5	Grs. 37.5	Grs. 38.5	Grs. 37.5	Grs. 28.	Grs. 22.5	Grs. 28.5	Grs. 40.8	Grs. 37.5	Grs. 36.5	Grs. 27.5	Grs. 34.5	Grs. 26.	Grs. 37.5	Grs. 35.5	Grs. 21.5	Grs. 39.5	Grs. 44.8	Grs. 44.8	Grs. 42.8	Grs. 42.5

D. F. SLIDES

40 equals	Grs. 19.	Grs. 17.5	Grs. 23.	Grs. 29.5	Grs. 34.5	Grs. 36.	Grs. 33.	Grs. 26.5	Grs. 17.	Grs. 24.	Grs. 35.2	Grs. 28.	Grs. 26.	Grs. 23.9	Grs. 29.	Grs. 21.	Grs. 30.5	Grs. 28.	Grs. 16.	Grs. 34.2	Grs. 37.	Grs. 38.1	Grs. 37.2
45 equals	Grs. 21.	Grs. 19.5	Grs. 25.5	Grs. 33.	Grs. 38.	Grs. 40.5	Grs. 37.	Grs. 29.5	Grs. 19.5	Grs. 26.5	Grs. 38.7	Grs. 31.	Grs. 29.	Grs. 26.3	Grs. 32.5	Grs. 23.5	Grs. 34.	Grs. 31.5	Grs. 18.	Grs. 38.2	Grs. 41.	Grs. 43.2	Grs. 40.7
50 equals	Grs. 23.5	Grs. 21.5	Grs. 28.5	Grs. 36.5	Grs. 41.5	Grs. 44.5	Grs. 40.5	Grs. 32.5	Grs. 21.5	Grs. 29.	Grs. 41.4	Grs. 34.	Grs. 32.5	Grs. 29.3	Grs. 36.	Grs. 26.	Grs. 37.5	Grs. 35.	Grs. 19.5	Grs. 42.	Grs. 46.5	Grs. 46.6	Grs. 44.5
55 equals	Grs. 25.5	Grs. 23.5	Grs. 31.	Grs. 40.	Grs. 45.5	Grs. 49.	Grs. 44.5	Grs. 35.5	Grs. 23.5	Grs. 32.	Grs. 46.6	Grs. 37.5	Grs. 35.5	Grs. 32.3	Grs. 39.5	Grs. 28.5	Grs. 41.	Grs. 38.5	Grs. 21.5	Grs. 44.2	Grs. 50.5	Grs. 51.2	Grs. 48.5
60 equals	Grs. 27.5	Grs. 25.5	Grs. 33.	Grs. 44.	Grs. 49.5	Grs. 53.	Grs. 48.5	Grs. 38.5	Grs. 25.5	Grs. 35.	Grs. 50.3	Grs. 40.5	Grs. 38.5	Grs. 35.3	Grs. 42.	Grs. 31.	Grs. 44.5	Grs. 41.5	Grs. 23.5	Grs. 48.3	Grs. 56.1	Grs. 57.1	Grs. 54.8
65 equals	Grs. 30.	Grs. 28.	Grs. 36.5	Grs. 47.5	Grs. 53.5	Grs. 57.5	Grs. 52.5	Grs. 42.	Grs. 27.5	Grs. 38.	Grs. 54.5	Grs. 44.	Grs. 41.5	Grs. 38.2	Grs. 46.5	Grs. 34.	Grs. 48.5	Grs. 45.	Grs. 25.5	Grs. 52.8	Grs. 59.3	Grs. 59.8	Grs. 57.8
70 equals	Grs. 32.	Grs. 30.	Grs. 39.5	Grs. 51.5	Grs. 57.5	Grs. 62.	Grs. 56.	Grs. 45.	Grs. 29.5	Grs. 41.	Grs. 58.4	Grs. 47.5	Grs. 44.5	Grs. 41.	Grs. 50.	Grs. 36.5	Grs. 51.	Grs. 48.5	Grs. 27.5	Grs. 56.5	Grs. 61.8	Grs. 61.8	Grs. 61.8
75 equals	Grs. 34.5	Grs. 32.5	Grs. 42.	Grs. 55.5	Grs. 61.5	Grs. 66.5	Grs. 60.	Grs. 49.	Grs. 31.5	Grs. 44.	Grs. 62.3	Grs. 51.5	Grs. 48.	Grs. 44.	Grs. 53.5	Grs. 39.5	Grs. 55.	Grs. 51.5	Grs. 29.5	Grs. 60.8	Grs. 66.8	Grs. 66.8	Grs. 66.4
80 equals	Grs. 36.5	Grs. 34.5	Grs. 45.	Grs. 59.5	Grs. 65.5	Grs. 70.5	Grs. 63.5	Grs. 52.5	Grs. 33.5	Grs. 47.	Grs. 64.5	Grs. 54.5	Grs. 51.	Grs. 45.	Grs. 58.5	Grs. 42.	Grs. 58.5	Grs. 55.	Grs. 31.5	Grs. 64.	Grs. 71.2	Grs. 71.2	Grs. 71.2
85 equals	Grs. 39.	Grs. 36.5	Grs. 47.5	Grs. 62.5	Grs. 69.5	Grs. 75.	Grs. 67.5	Grs. 56.	Grs. 36.	Grs. 50.	Grs. 68.5	Grs. 58.	Grs. 54.	Grs. 47.	Grs. 60.5	Grs. 45.	Grs. 62.	Grs. 58.5	Grs. 33.5	Grs. 68.6	Grs. 77.3	Grs. 77.3	Grs. 75.3
90 equals	Grs. 41.	Grs. 38.5	Grs. 50.5	Grs. 66.	Grs. 73.5	Grs. 79.5	Grs. 71.5	Grs. 59.5	Grs. 38.	Grs. 53.	Grs. 71.5	Grs. 62.	Grs. 57.5	Grs. 49.	Grs. 64.	Grs. 47.5	Grs. 65.5	Grs. 61.5	Grs. 35.5	Grs. 72.2	Grs. 81.8	Grs. 81.8	Grs. 79.2
95 equals	Grs. 43.5	Grs. 41.	Grs. 53.	Grs. 69.5	Grs. 77.5	Grs. 84.	Grs. 75.5	Grs. 63.	Grs. 40.	Grs. 56.	Grs. 75.5	Grs. 65.	Grs. 60.5	Grs. 50.5	Grs. 67.5	Grs. 50.5	Grs. 69.	Grs. 65.5	Grs. 37.5	Grs. 76.2	Grs. 86.5	Grs. 86.5	Grs. 84.2
100 equals	Grs. 46.	Grs. 43.	Grs. 56.	Grs. 73.5	Grs. 81.5	Grs. 88.	Grs. 79.	Grs. 66.5	Grs. 42.	Grs. 59.	Grs. 81.5	Grs. 68.	Grs. 63.5	Grs. 53.	Grs. 71.5	Grs. 53.	Grs. 72.5	Grs. 68.5	Grs. 39.5	Grs. 80.	Grs. 91.	Grs. 91.	Grs. 88.1

portion of the measure a little blow. This blow does two things, it insures all the grains of powder which have been measured off by the measure being jarred into the shell, and it insures the even jarring down of the powder in the reservoir so as to uniformly fill the measure each time it is presented to the powder in the reservoir. EMPTY THE POWDER IN THIS FIRST SHELL BACK INTO THE RESERVOIR AGAIN BECAUSE THE FIRST SHELL IS APT NOT TO BE EXACTLY CORRECT AS TO CHARGE. Then proceed with filling all the shells with powder in this manner, keeping your wits about you, and being sure that each shell gets its full, uniform, properly jarred down load, and no more. Take the shells in rows of ten. If you are forced to stop while filling the shells, make a careful inspection before you start in again. See that all the shells to your left are absolutely empty, and that all on your right have the full charge. Have a regular method of working, and let nothing break the rhythm of it. In this way you are perfectly safe, and you will get uniform results.

Having all the shells filled, we are ready to seat the bullets. Insert the double adjustable chamber in the reloading tool. This chamber has a crimping shoulder in it. You *do not* want to crimp your shells as they are to hold the bullet merely friction tight. Therefore the chamber should not be screwed up into the tool far enough to make this crimping shoulder crimp the shell. (By crimping the shell is meant bending or crimping the mouth of the shell into a groove in the bullet in order to hold it. The particular bullet in the case before us has no groove and is intended to be held securely in the shell by having the shell slightly smaller than the bullet and then forcing the bullet into the small neck.) Now take a ready loaded factory cartridge and place it into the chamber and close the tool. Screw up the lower end of the double adjustable chamber until the pressure is felt on the upper handle. In other words, screw up the lower portion of the chamber so that it will just seat the bullet to the standard depth, and no more. Now we are ready to seat our bullets in the filled shells. Take a shell in the left hand, keeping the muzzle up so as to avoid spilling the powder. Take a bullet in the right hand and insert its base into the mouth of the shell. It can be stuck in by the fingers a very slight distance so that it will balance itself there. Then take the reloading tool with the tool upside down, that is the chamber above the jaws, and insert the cartridge into the chamber, closing the handle and seating the bullet to the required depth. No force will be required to do this, the handle closing easily. Extract the cartridge and place it to one side. If the

bullet gets off of the mouth of the shell, and the tool is then closed, of course the bullet will not enter the shell, and if pressure enough is exerted one side of the shell will be mashed down and deformed. To avoid this, just as you insert the shell with bullet balanced in its mouth into the chamber push it up snug into the chamber and give the base of the shell a slight twist, and you can feel the bullet being centered correctly over the mouth of the shell, then hold it there with one finger while you close the handle. This completes the operation of reloading. Wipe off all the various tools with an oily rag except the inside of the reservoir of the powder measure. It is well to keep the powder measure filled with powder until the very end of the reloading, as you may spill the powder in some shell and wish to refill it. Empty the powder measure, running the surplus powder back into its can, and you are through.

In the above example the various little details which are learned by experience have been very fully gone into, and described minutely in an effort to pave the way of the novice and render the first trial easy to the end that more may resort to reloading their shells. The question will at once present itself, how long does all this take? I carefully timed myself through this entire operation, including the time necessary to get the materials off of the shelf above the loading bench, and to set up and adjust the tools, and it totalled up as follows for one hundred cartridges:

Extracting primers	4	minutes	30	seconds
Resizing shells	5	"		
Enlarging necks of shells	5	"	15	"
Priming shells	8	"		
Adjusting powder measure	3	"		
Filling shells with powder	2	"	30	"
Seating bullets	6	"	10	"
<hr/>				
Total time	29	minutes	25	seconds

The novice should be able to approximate this speed about the fifth trial. As I only go through the operation of reloading, say, once a month, I am not necessarily very skilled at it to the extent of speeding it up.

We have followed very thoroughly the simple case of reloading with jacketed bullets purchased at the factory, and smokeless powder. There are a few other operations that we need to be familiar with.

WEIGHING POWDER CHARGES

The Ideal powder measure will measure the finer grained powders very accurately. In small charges the error is probably not greater than half a grain. However, some of the long tubular grains of the coarser powders stack up quite a little in the measure so that the charges are liable to differ as much as $2\frac{1}{2}$ grains, and this is entirely too much of an error, especially where one is loading charges giving high breech pressures. When loading a cartridge giving the highest allowable pressure for a certain rifle a couple of grains over is liable to run the pressure up to such an extent that the primer is either pierced, or the primer pocket enlarged. This results in an escape of powder at very high pressure to the rear. This escaping powder may seriously injure the breech mechanism of the rifle, may even completely wreck it and seriously injure the shooter, or at the very least it will jam the rifle.

To get the most accurate results from a cartridge the powder charge should be uniform. Uniform charges are required for uniform velocity. A difference of 1 grain in weight of powder charge in the .30-caliber, Model 1906 cartridge will cause a difference in striking point on the 1000 yard target of about 20 inches, but the difference will not be proportional at shorter ranges. A difference of 1 grain in this cartridge would not, for example, cause 2 inches difference in point of impact at 100 yards, but it would cause a slight difference nevertheless. For the best results in target shooting, particularly in long-range shooting, it is very desirable that powder charges be weighed, and not measured, to get them absolutely uniform. Here is where the hand loader can improve on the factory product, as the factory must speed up in order to reduce cost of manufacture, and cannot rely on getting charges much more uniform than within say half a grain, whereas the rifleman reloading himself, and taking pains, can get every charge uniform to within about $\frac{1}{10}$ grain. The difference between errors of $\frac{1}{2}$ grain and $\frac{1}{10}$ grain will result in a difference of about 8 inches in the size of the shot group at 1000 yards, other things being equal.

As a rule it is best always to weigh the charges when using the following powders: Du Pont powders Nos. 10, 13, 15, 16, and 20. Hercules W. A. 30-caliber powder. The other powders will measure quite accurately in the Ideal powder measure, plenty accurately enough for hunting and for all uses except the very finest target shooting and experimental work.

Any delicate scales weighing to within $\frac{1}{10}$ grain troy weight, and having a capacity of from 5 to 70 grains, is satisfactory for weighing powder charges, but often the rifleman may wish to weigh bullets or complete cartridges as well, and it is better, if purchasing a new set of scales, to purchase one having a capacity up to 500 grains at least. One of the best scales, the one usually used by expert riflemen, is made by the Fairbanks Company, and is known as the Miner's assay scale. It costs in the neighborhood of \$10. The weights are not loose, but are attached to an arm, which is a great advantage. In using the scales they should be set up on a fairly level table and then carefully levelled. Never try to use them where there is any current of air as no accurate results can be obtained where wind blows on the scales. After getting the scales set up, always test them by placing the weights on the arm at zero (or in the case of separate weights, removing all weights) and see if the scale balances correctly at zero.

The weighing is best done in conjunction with the Ideal powder measure. Set the powder measure to give about one grain less than the required amount. Hold the detachable pan of the scales under the powder measure and throw the charge on to the pan. Place the pan on the scales, where it will of course weigh too light. Have an empty shell of a caliber other than that which you are reloading so as not to get the two mixed, filled with powder, and gently tap a little of this grain by grain into the pan until the pointer or arm of the scales comes to zero, showing the correct weight. Have a little funnel rigged up so that the end of its tube is several inches above the table. Place a shell under the funnel, carefully lift the pan off the scales, and empty the powder into the shell, giving the funnel a slight tap so as to be sure that all the powder runs into the shell. It takes time to measure powder charges, probably about one minute per round. A powder scale is also a great convenience to measure the first two or three charges thrown from the powder measure in any case, as then one always knows exactly how much powder he is using. Personally, even when I am going to use the powder measure alone for loading, I always weigh the first two or three charges to see that the measure is throwing the exact amount, but this is a little nicety that is not absolutely necessary except where positive results are necessary.

SEATING LEAD AND ALLOY BULLETS

When lead bullets, or bullets composed of an alloy of lead and tin, are to be seated in shells the inside of the neck of the shell should be sized down and then expanded so that it is about .00025 inches smaller than the bullet just as in the case of metal-jacketed bullets. Another operation is needed also, for if one attempts to seat a lead bullet in such a shell with no further treatment the sharp corners of the mouth of the shell will shave the bullet, making it smaller in diameter, and causing a film of lead to over-ride the outside of the shell. So the sharp edge of the mouth of the shell must be chamfered or bevelled off slightly to remove the square corner. This can be done with a knife, but when the knife is used for this purpose so great care must be taken to get each shell uniformly bevelled, and only slightly so, that it takes a great deal of time. It is very much better to procure an Ideal shell chamfering reamer which does the work perfectly and very quickly. The tool is inserted in the mouth of the shell, given a complete turn under slight pressure, and the job is done. Then invert the shell and give it a tap on the table to insure that no brass shavings remain inside the shell. A shell once chamfered need not be so treated again, also it apparently does not injure the shell for use with jacketed bullets. The bevel need not be at all large. In fact it should be as small as possible, a very small bevel sufficing to take the sharp edge off and prevent the shaving of the bullet.

BULLET MOULDING

The moulding of lead and alloy bullets is an art in itself. It takes quite a little practice to become proficient at it. I should say that a careful man can learn to turn out perfect bullets in about five trials. Certain facilities are absolutely necessary, and it is practically impossible to turn out good, well-formed bullets on the kitchen stove or camp fire. The outfit necessary is as follows:

- 1 Ideal bullet mould for the bullet desired.
- 1 Ideal dipper for running bullets.
- 1 Ideal melting pot, or similar plumbers melting pot.
- 1 pair heavy leather gloves.
- 1 blanket.
- 1 stick of hard wood.
- 1 stove for melting the lead.
- A small quantity of heavy grease or bullet lubricant.

The best stoves for the use of the individual rifleman are either a Primus stove, burning kerosene vapor, or else a Bunsen burner for

gas. Either of these will do excellent work. Arrange the stove on a small box, so that the top of the stove will come several inches above the top of the chair on which you are going to sit. The operation will take a couple of hours so you should make yourself comfortable, and also you will need plenty of fresh air, but not a breeze which would



Fig. 83
Ideal bullet mould and dipper

bother your stove. It will be a pretty hot job. To the left of the stove should be a low table or box over which is spread the blanket, folded to five or six thicknesses. On the right side you should have a large tin box, or old tin can into which you will from time to time dump the dross.

Bullets are almost always alloyed with tin to make them slightly harder. Pure lead bullets are suitable only for black-powder rifles having very low velocity and a very slow twist of rifling. Bullets for the .45-70 Springfield and Winchester rifles, for example, are cast of an alloy of 1 part by weight of tin to 16 parts of lead, and in

weighing out the metal to be used weigh out 1 ounce of tin to every 16 ounces of lead. If the bullets are intended for use in short-range loads in high-power rifles they should be cast of a 1 to 10 alloy. Bullets for the .32-40 and .38-55 do very well at 1 to 32. But when we come to black-powder rifles it is hard to say just what the alloy should be, as so much depends upon bullet upset, and as a rule the rifleman will have to do a lot of experimenting with different alloys and different lots of powder to get the best results. For bullets to use in .30-caliber rifles and others having very quick twist the Ideal Manufacturing Company make up two hard alloys called Ideal bullet metal. Ideal bullet metal No. 1 is composed of 80 parts lead, 7 parts of antimony, and 3 parts copper. It makes a very hard, tough alloy, much harder than the rifleman himself can mix unless he has some knowledge of metallurgy. It is recommended particularly for gas-check bullets in rifles having very quick twists such as the .30 calibers, the .25-35 caliber, and various small-bore, foreign rifles. It also mixes or amalgamates better with pure lead than does tin, and so can be used to make softer mixtures, mixing it with pure lead in accordance with the following table:

1 part tin to 10 parts lead equals 1 part Ideal bullet metal No. 1 to $\frac{1}{4}$ parts lead.																				
1	"	"	"	15	"	"	"	"	"	1	"	"	"	"	"	1	"	3	"	"
1	"	"	"	20	"	"	"	"	"	1	"	"	"	"	"	1	"	$4\frac{1}{4}$	"	"
1	"	"	"	25	"	"	"	"	"	1	"	"	"	"	"	1	"	$5\frac{1}{2}$	"	"
1	"	"	"	30	"	"	"	"	"	1	"	"	"	"	"	1	"	$6\frac{3}{4}$	"	"
1	"	"	"	35	"	"	"	"	"	1	"	"	"	"	"	1	"	8	"	"
1	"	"	"	40	"	"	"	"	"	1	"	"	"	"	"	1	"	$9\frac{1}{4}$	"	"

Ideal bullet metal No. 2 is composed of 90 parts of lead, 5 parts of tin, and 5 parts of antimony. This mixture is just suited to Ideal gas-check bullets when used in ordinary sporting rifles having twists slower than one turn in ten inches. It is also excellent for alloy bullets without gas-check for all types of rifles where the twist is quicker than one turn in 16 inches, and where smokeless powder is used. It can be alloyed with pure lead to give a softer bullet in accordance with the following table:

For	1	to	15	alloy	add	$\frac{1}{2}$	part	lead	by	weight.
	1	"	20	"	"	1	"	"	"	"
	1	"	25	"	"	$1\frac{1}{2}$	"	"	"	"
	1	"	30	"	"	2	"	"	"	"
	1	"	35	"	"	$2\frac{1}{2}$	"	"	"	"
	1	"	40	"	"	3	"	"	"	"

It is well to work with quite a lot of metal at a time, about 10 pounds is correct, because this amount will hold its heat well, and

will run much better bullets than a smaller amount. What is not used can always be retained in the pot and used again. When through with the lead in the pot always scratch figures on it giving the proportions of the alloy so that the next time you come to mould bullets you will know just the hardness of this piece of lead.

Place the pot on the stove and start the latter going. If it is a Primus stove you will need to keep it going to its full capacity almost all the time. Put a small quantity of lead in first, cut in thin pieces as it will melt quicker. After you have a little pool of molten lead in the pot you can stick the end of a billet of lead in it and it will quickly melt up. In this way you will get the lead melted much quicker than if you placed a great quantity in at a time. After the lead is all melted, put in the tin, and when it is melted stir the metal a little. Then add a piece of thick grease, beeswax, or bullet lubricant about the size of a chestnut and stir rapidly. Much smoke will be given off. This will flux the metal and make it flow better. Then stir rapidly. The surface of the metal will now be found covered with a varicolored dross. This should be skimmed off and thrown into the can at your right side. While you are moulding bullets, the metal should always present a bright, clear, mirror-like surface. A little dross will arise from time to time and will have to be skimmed off. If too much arises it is a sign that your metal is too hot. The metal should be hot enough to flow freely, but never too hot. Always use the Ideal dipper for skimming and for pouring lead into the mould. Keep it in the metal at all times as it must be as hot as the metal, or metal in it will chill, will not pour well, and will stick to the dipper. Never use an ordinary open dipper, as perfect bullets cannot be obtained with it, and of course anything but perfect bullets are absolutely useless.

A NEW MOULD WILL NOT CAST GOOD BULLETS. It must first be used until it becomes thoroughly oxidized and blued, and this is best accomplished by casting bullets in it, and throwing them back into the pot until the mould gets broken in. Sometimes one will have to cast several hundred bullets in a new mould before it gets to working smoothly. **MOREOVER THE MOULD MUST BE VERY HOT, ALMOST AS HOT AS THE METAL, TO CAST GOOD BULLETS.** The lead and the mould should be kept at such a temperature that it will require about three seconds for the lead in the pouring hole of the mould to solidify after it has been disconnected with the dipper. From this one will see that when he has a new mould he cannot expect even fair results for an hour

or two after he starts in. With an old, well-broken-in mould, good bullets will start to come as soon as the mould has gotten to the required heat. While the lead is melting place the bullet mould alongside the outside of the pot where a little flame from the stove will heat it, thus warming it up.



Fig. 84

Ideal dipper, bullet mould, and melting pot, showing method of connecting dipper to mould when running bullets

When ready to run the bullets, raise the dipper nearly full from the pot, hold the dipper over the pot, and connect the mould to the nozzle of the dipper, then turn the dipper with the mould connected, slowly to the vertical position (see Fig. 84), and the weight of the metal in the dipper above the mould will drive out the air and fill the mould perfectly, assuring good, full, smooth bullets without the spilling of a particle of metal. With an open dipper you cannot get this perfect filling of the mould. After the nozzle of the dipper has been in contact with the mould for several seconds in the vertical position, quickly tilt the dipper back, and part it from the mould, leaving a little lead in the pouring hole in the cut off of the mould. It should take this lead in the pouring hole about three seconds to solidify if everything is at the right temperature. Hold the mould closed for about three more seconds after the lead in the pouring hole solidifies, then strike the cut-off arm of the mould with a billet of wood, causing the lead in the skrew hole to fall back into the pot, then shift the mould over to the left, and hold it a couple of inches above the folded blanket, and open the handles. The bullet should drop out on to the blanket if the mould is a perfect one. As a matter of fact it seldom does. A mould which will always drop out its bullets is a joy forever. Usually the bullet will stick slightly to one or the other half of the mould. If so tap with the billet of wood on the extreme end of the

wood handle of the mould attached to the half of the mould to which the bullet is sticking, tapping towards the bullet, and the bullet will almost always fall out without deforming itself. Or else hold the half in which the bullet sticks with the bullet downward, over the folded blanket, and tap the under side of the mould near the bullet lightly. Never strike the mould with a hammer or other metallic substance, for it will ruin it. The hinge joint of the mould should be occasionally touched with grease or beeswax to lubricate it. Never try to pry a bullet out of a mould as it is impossible to use any sharp metal tool across the sharp corners of the mould without ruining it. If the handles of the mould become too hot dip them in a pail of water. Never attempt to heat the mould by immersing it in the metal, for slag will burn on it and ruin it. Remember that a new mould takes a long time to break in, and you will have to scrap many bullets at first. Examine the bullet as you open the mould, and if it is not absolutely perfect, full, smooth, and clean cut in every respect, scrap it by emptying it back into the pot again instead of on to the blanket. In dropping bullets on to the blanket see that they do not strike each other as they are very soft when hot, and are easily damaged in this way. Always have a good, soft surface to drop them on. Dropping bullets on a board ruins them. Remember, the only kind of a bullet you have the slightest use for is one which is perfectly formed, of the exact weight, exactly round, and with a perfectly square base. This means that everything must be working perfectly, and that after moulding the bullets they should be handled carefully, removing them from the blanket one by one, and either standing them base down on the loading table to be lubricated, or else stacking them carefully in paste board boxes. I remember once an enthusiastic rifleman showing me some bullets he had moulded. He had them loose in a cigar box, and as he exhibited them he tilted the box from side to side, rolling the bullets around. Not one of those bullets was fit for shooting, as all their bases were dulled unevenly.

A good mould, well broken in, is a precious article. Take care of it by covering it inside and out with heavy wax after use, and before it gets cold, and then put it away in a small wood box, not cardboard box, because cardboard absorbs dampness badly. Do not wrap it in a woolen cloth for the same reason. All metal articles are best protected from rust by drying them thoroughly after cleaning, then covering them with heavy grease, and then packing them away where nothing but wood will touch them.

LUBRICATING AND SIZING BULLETS

Bullets are always cast several thousandths of an inch larger than the standard, the bullet moulds being made slightly oversize, and it is

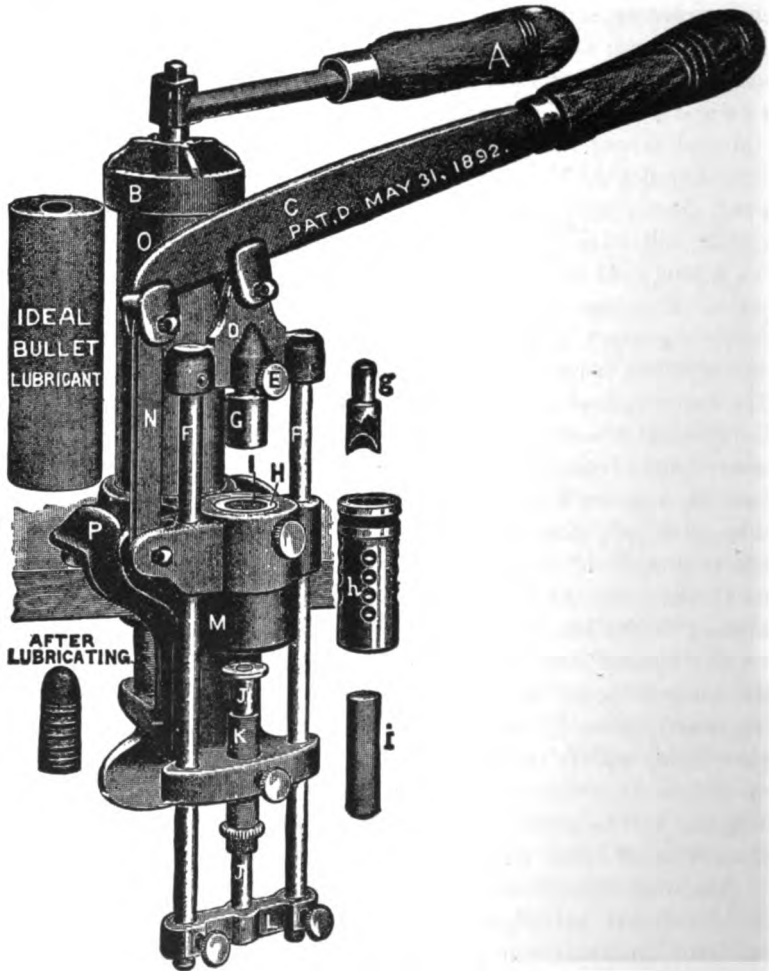

Fig. 85
Ideal lubricator and sizer

intended that they shall be sized down to the required size. Most reloading tools contain a sizing hole and a plunger. They are absolutely worthless. Do not attempt to use them. Besides the sizing

die should be specially made of the correct diameter for your particular barrel.

Also bullets should always be lubricated; that is, should have their grooves filled with lubricant. This should be done before sizing them, as it makes them pass through the sizing die easier, and the die presses the lubricant well into the grooves. Bullets can be lubricated by placing them base down in a pan, and pouring the melted lubricant around them until it arises above the top groove. Then when the lubricant is cool, take a shell which has had the head cut off, and which has been enlarged a little at the neck, and press it down over bullet, after bullet. This cuts the surplus grease off, and the bullets pass upward through the shell. This is a crude method, much lubricant flakes off, and it is not to be recommended.

For several years I tried various methods of lubricating and sizing bullets without even fair success. The bullet was usually poorly lubricated, and practically ruined in the sizing process. Then the Ideal Manufacturing Company placed their Ideal bullet lubricator and sizer on the market, and the rifleman's troubles in this respect were at an end. This machine does the work so perfectly that no one who moulds his own bullets can possibly get along without it. There is nothing else on the market like it, so I do not hesitate to recommend it. The machine will take sizing dies adapted to bullets of any size, and one can have a number of dies for his various rifles and bullets and use them in the one machine. The machine here illustrated (Fig. 85) first sizes the bullet, then while the bullet is still in the sizing die it receives the lubricant under considerable pressure, and the forcing of the bullet out of the die removes all the surplus lubricant.

For many years riflemen have experimented with various lubricating materials. Mr. E. A. Leopold, an old-time rifleman of Norristown, Pennsylvania, invented a lubricant which he called "Banana Lubricant" which was so excellent that it was quickly adopted by practically all expert riflemen. He made it for many years for the Ideal Manufacturing Company. It is made in sticks correct for use in the lubricator and sizer. To date no one else has discovered a lubricating material which can touch it. Full instructions for the use of the lubricator of course accompany the machine.

CLEANING SHELLS

Shells which have been fired with smokeless powder do not need any cleaning unless they are to be left loaded for a long time, say

several years. They must of course be carefully cared for after they are fired, and before reloading. Do not permit them to get dirty, wet, or injured.

Shells which have been fired with black powder must be thoroughly washed, cleaned, and quickly dried, or they will corrode badly. Corroded shells are weakened, they will not contain as much powder, and they will in time ruin the powder in them. To clean black-powder shells, decap them and place them in a pan of very hot water and soap suds. Scrub them out inside with a bristle brush, changing the water frequently until the shells no longer make the water dirty. Then wash them again in a little very hot water in which several teaspoonsful of vinegar has been placed, and then rinse them again in clear water. Finally put them in a pot of water and boil them. Then, while still boiling, pour them into a colander, shake them a little, and swing over the hot stove for several minutes. Effort should be made to get them dry of their own heat within about five minutes of taking them from the last water. Never place them in a hot oven to dry as this will anneal them, and make them so soft that they will be useless. It will often be necessary to use a piece of cloth on a sharp stick to clean out and dry the primer pockets, and this should be looked after especially as no dampness should be left here for corrosion in this portion of the shell is very serious.

This method of cleaning will not suffice with shells which have been fired with smokeless powder, as the smokeless residue is very tenacious, and soap and hot water make no impression on it. Acid must be used, but used in such a manner that it does not injure the brass. Procure two large glass jars. Preserve jars with large necks will do nicely. Fill No. 1 with a solution of 1 quart of water, 2 fluid ounces of sulphuric acid, and 2 ounces of potassium bichromate. Similarly fill No. 2 jar with a solution consisting of one-fourth pound of potassium cyanide in one quart of water. Be careful of these solutions as they are both of them deadly poison. If mixed they will be ruined, and will also give off poisonous fumes. It is best to place one of these jars on either side of a stationary wash basin full of running water, but a bucket of water between them will answer well if the water is changed frequently.

Take a short piece of *steel* or *iron* wire and bend it in the form of a double hook, using it to dip the shells with. Two shells are washed at a time. Rinse the shells, first in the water in the middle receptacle, then dip them in No. 1 solution for not more than five seconds, then

rinse thoroughly in the water, then dip in No. 2 solution for several seconds. If this does not make them bright all over rinse off again and go through the dipping in each solution again. Always rinse thoroughly after dipping in each solution. Finally, after dipping in the No. 2 solution for the last time, drop the shells in a pan of clean water. After you have cleaned all the shells in this manner, and they are all in the pan of clean water, place them in a kettle, boil them, pour into a colander, shake, and swing them over a stove for several minutes so as to make them dry quickly of their own heat. In cleaning the shells change the water in the rinsing basin or bucket frequently so as to keep it clean. The solutions can be used over and over again many times until they fail to clean quickly. This method results in shells as clean as when new, and does not injure the shells.

The secret of preventing corrosion when washing shells is to get them to dry thoroughly within five minutes after removing them from the last water, but they must never be subjected to excessive heat or they will anneal or soften.

THE "IDEAL HANDBOOK"

The Ideal Manufacturing Company of New Haven, Connecticut, make practically all the reloading tools made in this country. They issue a catalogue called the "Ideal Handbook." This is really a manual of instruction in reloading, and is full of valuable information to riflemen and particularly to those who reload their own ammunition.

Before closing this subject it is perhaps well to call attention to the fact that loading ammunition as distinguished from *reloading* is also profitable, as one can purchase *shells*, bullets, primers, and powder at a combined cost of less than factory-loaded cartridges, and assembling them with reloading tools, make a considerable saving.

CHAPTER XIV

TRAJECTORY

THE trajectory of a bullet fired from a rifle is dependent upon its initial velocity and its remaining velocity. The greater these are, the smaller will be the time of flight over any range, and the flatter will be the trajectory. A flat trajectory, and its necessary accompaniment of high velocity, is a great advantage in any cartridge. It is especially advantageous to the rifleman who has to fire at estimated ranges, to the hunter and the soldier, because it minimizes the errors that result from an incorrect estimate of the range. Suppose we estimate the range to a certain big-game animal to be 150 yards, and we set our sights accordingly. Now suppose that this range is actually 200 yards, and we have made an error in the estimate of 50 yards. If we are using a rifle of high trajectory like the .45-70-500, our bullet will strike about 14 inches low, enough to pass under the body of the animal. Suppose, however, we are using the .30-caliber, Model 1906 cartridge with a velocity of 2700 feet per second, and a very flat trajectory. From 150 to 200 yards our bullet will only fall about 5 inches, and we still stand a chance of getting a hit in a vital part.

The target shot usually fires at known ranges and he is not troubled with errors from incorrect estimate of the range. Nevertheless a flat trajectory is of importance to him also, because a flat trajectory is always accompanied with high velocity and a short time of flight, and this means that the bullet will be in the air a shorter time to be influenced by the wind. Certain slight changes in the velocity of the wind, which with a low-velocity bullet would cause enough deflection to make the bullet miss the bull's-eye, would not cause enough error to take a high-velocity bullet out. For example, we found when we used the .30-40 Krag rifle with a muzzle velocity of 2000 feet per second and a 220-grain, blunt-pointed bullet at long range, that slight changes in the velocity of the wind, changes so slight that even the most expert could not estimate them without an anemometer, would frequently drift the bullet out of the bull's-eye, sometimes even as far as a "three." When we changed to the .30 Model 1903 rifle, using the 150-grain sharp-pointed bullet at 2700 feet per second we found that almost all our trouble with these slight changes of wind velocity were gone, as they

were not sufficient to drift the bullet out of the bull's-eye, and hence we were able to make much better scores.

Ever since the adaptation of high-velocity rifles to sporting purposes some twenty years ago the majority of sportsmen have regarded the flatness of trajectory as being the most important element in a hunting arm. The questions always asked are: How flat is its trajectory? What is its velocity? The thought is that the flatter the trajectory, the longer the range at which sure hits can be made, and the less important the question of accurate estimate of range. Other things being equal, these facts are undoubtedly so; but are other things always equal? How about accuracy? Will a cartridge which, when fired at 200 yards raises only 4 inches above the line of aim at 100 yards, give as good accuracy as another which raises 6 inches? Suppose we have two rifles, one giving a 4-inch trajectory at 200 yards and requiring a 12-inch circle to hold its group of 10 shots at that range, and the other having an 8-inch trajectory but only requiring a 4-inch circle to hold its group. Which will have the longer point-blank range at which sure hits can be made?

Some years ago Horace Kephart discussed the subject of trajectory and point-blank range as follows: "Thus, for example, let us say that an 8-inch disk represents that part of a deer in which a bullet may be counted upon to inflict a mortal wound; then the deer's killing zone would be that distance throughout which the trajectory of the bullet would cut an 8-inch disk. For open country, where long shots are the rule, the rifle may then be sighted for an extreme rise of 4 inches above the line of aim, and the killing zone for deer will extend to that point where the descending bullet falls 4 inches below the line of aim. Remember that the line of aim or sight is different from the line of fire (prolongation of axis of bore), and that it is in the shooter's favor, as will be seen below.

"Assuming, for example, that the highest point of the trajectory above the line of fire is 4½ inches for a given rifle when sighted to strike center at 160 yards, and that this highest point is at 80 yards (it would really be a little nearer the target but the difference is trifling at short ranges), also that the top of the front sight is 1 inch above the axis of the bore, then the trajectory would be about as shown in the following table:

Trajectory	Distance in yards							
	20	40	60	80	100	120	140	160
Above line of fire, inches	1.89	3.33	4.19	4.50	4.28	3.47	2.07	0
Sight allowance, inches	.87½	.75	.62½	.50	.37½	.25	.12½	0
Above line of aim, inches	1.02	2.58	3.46	4.00	3.90	3.22	1.94	0

This would be good for deer shooting up to about 200 yards without change of aim or estimation of distance.

“But such trajectory would be too high for shots near by. In the thick woods, where most shots are fired at from 40 to 100 yards, a rise of $2\frac{1}{2}$ inches at 40 yards, and $3\frac{1}{2}$ at 60 yards, would be excessive. For hunting in a locality where there is plenty of cover this rifle should be sighted to strike center at about 80 yards, and it would then shoot on a line practically level up to 100 yards.”

Let us suppose that the rifle referred to by Mr. Kephart was the old reliable .30-40 Winchester. We see that if the rifle be sighted for 160 yards and the game be 200 yards away, the bullet descending falls 4 inches below the line of aim, and the rifle will evidently give a sure shot into the vitals of a deer at this range. But is this absolutely so? Let us look at the accuracy for a minute. A large number of accuracy tests with this rifle have shown conclusively that the average size of groups at 200 yards is 7 inches. Thus if the rifleman does his part correctly he will be sure only of getting his shot within $3\frac{1}{2}$ inches of the trajectory line at 200 yards. We have seen that when the rifle is sighted for 160 yards it will fall 4 inches low at 200 yards, and that it will still hit in the vitals of a deer standing at that range. But will it? Suppose that the particular shot fired at that deer is the one which flies to the bottom of the group. That is, it flies $3\frac{1}{2}$ inches low. Now we have not 4 inches low for the hit on that deer, but 4 inches plus $3\frac{1}{2}$ inches, or $7\frac{1}{2}$ inches, and our shot misses the 8-inch vital disk by $3\frac{1}{2}$ inches. We cannot therefore be sure of killing game at 200 yards with this rifle with the sights set for 160 yards and the range unestimated. Two hundred yards is therefore beyond the point blank of this rifle for deer. It might be argued that a sure shot could be made at 160 yards were it not for the fact that we cannot surely estimate the range correctly.

By a similar computation we can figure out that, assuming that we do not attempt to estimate the range but use one sight setting and trust to flatness of trajectory to give us a vital hit, 140 yards is about the maximum range at which we can expect a sure hit under these circumstances, and with this cartridge. This is not very comforting. The foreign makers of the 8 mm. rifle advertise for it a 300-yard, point-blank range, and as the .30-40 has almost the same trajectory as the 8 mm., many hunters have come to regard that as the point blank of this arm. Here we find that in truth we must reduce it by 160 yards. We therefore see how inseparable we must consider trajectory and

accuracy. What is needed in our rifle catalogues and books is a table of accuracy as well as trajectory. One maker does indeed give the accurate range for his cartridges, but will some one please tell me what "accurate range" means? Does it mean the range at which one can, if he does his own part correctly, hit a squirrel's head, or an 8-inch disk, or the standard military target? If the latter, pray what bull's-eye do they refer to when they say that a rifle is accurate to 700 yards?

Let us now turn to a more cheerful example. We have discarded our old friend the .30-40 for reasons above stated, and we are looking for a new arm for big-game shooting with which we can make sure shots at a longer range. Let us consider either the Model 1903 government rifle or the Winchester Model 1895 rifle, each shooting the .30-caliber, Model 1906 cartridge. This cartridge occurs to us because we know of its fine accuracy and its extremely flat trajectory. Also we have positive knowledge as to its accuracy. Below is a trajectory table for this cartridge for point-blank, big-game range in open country calculated with Mr. Kephart's rule, to which I have added the mean vertical deviation of the cartridge. In this table the rifle is sighted for 200 yards, and we see that should the game be at 100 yards the greatest deviation that can occur due to accuracy and trajectory will be a shot 2.80 inches above the point of aim, while at 225 yards the greatest deviation will be a shot 3.82 inches below the point of aim. The rifle will surely strike within the 8-inch vital disk up to 225 yards. If the theory of probabilities be taken into account the point-blank, big-game range may be slightly increased, until with the rifle sighted for 250 yards 50 per cent. of the shots will strike within the 8-inch disk at 275 yards.

We thus again see how inseparably connected are trajectory and accuracy, and why, in making the choice of an arm, we should ask not only what is its trajectory and velocity, but what is its mean vertical and mean absolute deviation.

.30 MODEL 1906 CARTRIDGE. POINT BLANK TRAJECTORY FOR OPEN COUNTRY

	Distance in yards			
	100	200	225	300
Trajectory above line of fire, inches	2.50	0
Trajectory below line of fire, inches	0	1.90	9.00
Sight allowance, inches50	0	.12	.50
Trajectory above line of aim, inches	2.00	0
Trajectory below line of aim, inches	0	2.02	9.50
Mean vertical deviation, inches80	1.60	1.80	2.40
Maximum deviation from point of aim, inches	2.80	1.60	3.82	11.90

CHAPTER XV

KILLING POWER

THE discussion as to the killing qualities of the various cartridges when used on big game has been going on for many years; in fact, it is probably as old as is the use of the rifle on game. As far back as 1886 sporting papers devoted columns to the subject, while in the English press we have records of discussions of this character ninety years ago. And still sportsmen disagree. First we had the "big- vs. small-bore discussion," then the "high- and low-velocity discussion"; next we were treated to a dissertation on energy and foot pounds, and today it is all "explosive effect." We even see many men waxing eloquent in print on this subject who have never killed or seen killed a single head of big game in their lives. Therefore right at the start of this subject I had better qualify as to my right to discuss it by stating that as near as I can count up I have to date (August, 1917) shot with my own rifle seventy-two head of big game. I have killed all the big game of North and Central America except bear, caribou, white sheep, musk-ox, tapir, puma, and jaguar. In addition I have been in at the death of, and have examined the wounds of, at least one hundred and fifty head besides those I have killed myself.

What we should look for in a big-game cartridge is one that will cause the least suffering by killing as instantly as possible. While not sacrificing this killing power, we also need accuracy, so that we can surely hit a vital spot on our game; and flat trajectory, so that we can hit that spot at a distance, taking into consideration our error in estimating the range. What to look for in a big-game cartridge is, therefore, first killing power, second accuracy, third trajectory.

Probably the mightiest hunter who ever lived was Sir Samuel Baker, an Englishman, who hunted for many years during the middle of the last century in India, Africa, and also in North America. He killed every species of big game in these countries, his bag numbering many thousands. Rifles, and particularly their killing power, was a hobby of his, and he has left a lot of interesting literature on the subject. He had many special rifles made to his order in England. An extremely large and powerful man, he could handle arms of very heavy

weight and extreme recoil, which would have been absolutely out of the question for the ordinary sportsman. The largest rifle which he used on game weighed 20 pounds and had a barrel 36 inches long. It shot a bullet weighing $\frac{1}{2}$ pound and containing a bursting charge of $\frac{1}{2}$ ounce of fine-grained powder. The propelling charge was 16 drams of black powder. This was a veritable cannon. His favorite weapon for all game except buffalo and elephant was a .577 double-barrelled rifle, carrying a solid lead bullet of 648 grains, and a charge of 6 drams of black powder. He always was very strong in his condemnation of the light, hollow-point, express bullet. He states that after many years of experience in all the game fields of the world it is his opinion that the most killing missile that one can use against game is the largest bullet of soft lead that one can fire with comfort from the shoulder. Our own experience in black-powder days was exactly similar to this. We found that the large heavy bullet was always the better killer, and that light, hollow-point bullets could not be depended upon except for thin-skinned, easily killed game. What was needed was a bullet that would surely drive straight through into the vitals, in no matter what direction the animal was facing. Light bullets would often go to pieces and be stopped by a heavy bone, thus failing to reach a vital part. Most any rifle would kill if one got a fair, standing, broadside shot, and could aim accurately so as to reach the heart, but game cannot always be found standing in this position. Indeed the usual target one has will be a rear shot at game running away, and what is wanted is a bullet with a charge behind it that, in such a position, will plow right through into the chest vitals without being deviated or stopped by striking a heavy bone. The experience of our older hunters has been that by all odds the most killing rifle that was made in America in black-powder days was that shooting the .45-caliber bullet weighing 500 grains. This bullet was a much better killer than the .45-330 hollow-point bullet, or any of the lighter or smaller caliber bullets. It is to be understood that in the days of black powder the velocity varied only from about 1300 feet per second to about 1500 feet per second. All lead bullets expanded on hitting game to about double their diameter. The light, hollow-point bullets expanded a little more than the solid bullets, but were liable to break into several small pieces, lacked penetration, and were liable to deflection by bones. They were therefore not as reliable as the long, heavy bullet. These lead bullets at low velocity did little damage to tissue that was not directly in the path of the bullet.

Upon the advent of smokeless powder and small-caliber rifles, sportsmen evinced a desire to use them as sporting arms, believing that their flat trajectory would be of great advantage in game shooting. Catering to this demand, the factories turned out experimentally some soft-nose bullets; that is, bullets on which the metal jackets did not extend clear up to the point, but left from one-eighth to one-quarter of an inch of lead exposed at the nose. Upon trial it was found that such bullets were excellent killers on large game. The bullet expanded well, held together, and, moreover, seemed to "pulp" the tissue for several inches around the bullet hole. An extended experience proved that even here the long, heavy bullet had a decided advantage over the light bullet, the latter often being deflected and going to pieces on very large bones. For example, it was found that the long 220-grain bullet used in the .30-40 Krag cartridge was a much better killer on all game above deer than the light 160- or 170-grain bullet of the .30-30 rifle. The first small bore, smokeless, high-velocity bullets were all of .25 or .30-caliber, and sportsmen gradually came of the opinion that such rifles, and particularly the .30-40, exceeded in killing power any of the larger bores, even the .45-70-500. I cannot say that I personally share this opinion. I have killed many head of game with the black powder arms, and of course in late years with the small caliber, high-velocity arms, and with the latter arms I have never gotten the large proportion of clean kills that I used to get with the heavy black powder rifles. With these latter rifles time after time the game has dropped so quickly to the shot that I did not see it go down on account of the view being momentarily blotted out by the recoil. With the smokeless arms the game seems to stagger around for several seconds before going down, or else runs madly for from 50 to 100 yards before dropping. In this opinion I am backed up by quite a few sportsmen of extended experience, and particularly by Mr. James H. Kidder of the Boone and Crockett Club, the first sportsman to hunt the Alaska brown bear extensively. On these bear Mr. Kidder used both a .30-40 Winchester Model 1895 rifle and a .45-70-405 Winchester Model 1886 rifle. Mr. Kidder's experience was so extensive and so fortunately comparative as to leave no doubt whatever that on large bear the .45-70-405 with a muzzle energy of 1560 foot pounds was a much more killing cartridge than the .30-40 which has a muzzle energy of 1950 foot pounds.

An occasional failure of the small bores on the largest game led to the placing on the market about 1903 of such cartridges as the .35 Winchester with 250-grain bullet and the .405 Winchester with a 300-grain

bullet, and these calibers proved to have much greater killing power than the first small-bore, high-velocity arms.

I do not wish it to be considered that I believe the old, heavy, black-powder arms to be better game guns than the high-velocity, smokeless arms. As I said at the start of this chapter, there are other things to consider besides killing power; and the absence of smoke, the light recoil, the superior accuracy, and the high velocity of modern arms make it a much easier task to surely hit in a vital part, which fully makes up for the slightly superior shocking qualities of the large, heavy, soft-lead bullet. When the factories began to give us high-velocity, smokeless rifles of larger bore and using heavier bullets, we began to come nearer to the ideal big-game rifle, for we retained the lack of smoke, the light recoil, the accuracy, and the flat trajectory, and at the same time we got back some of the qualities of the old, big, black-powder rifles—the shocking power and the ability of the bullet to penetrate straight through in the direction in which aimed, no matter how the animal faced. Our heaviest rifle, the .405 Winchester, particularly excels in this respect.

About 1906, rifles with the extremely high velocity of 2700 feet per second began to appear. These were first brought out as military arms, and had a light, extremely sharp pointed, full-jacketed bullet. At first it was thought that such a bullet would penetrate cleanly, making only a very small hole. On trial, however, it was found that they had an explosive effect on tissue, and that they made extremely bad wounds and had good killing power. On striking they seemed to spin around on their points, often penetrating sideways, and the high velocity apparently gave an explosive effect to their blow so that the tissue for a considerable distance around would be completely blown to pulp. This effect, as stated, occurred with the full-jacketed, light, sharp-point bullet. Such bullets were used considerably on game, but it was quickly found that they had one undesirable quality. They were found very frequently to glance off at a considerable angle when striking a bone, instead of penetrating into the vitals in the direction in which aimed. There are on record a number of instances where such bullets, aimed at an animal standing broadside, have struck a rib, and, glancing, have almost encircled the animal just under the skin, inflicting a painful, but not at all a killing, wound. The light, 150-grain .30-caliber, pointed bullet was a particular offender in this respect. The 170-grain bullet of the same caliber seems to have been a much better killer. The factories took the matter up and quickly placed on the market soft-point,

sharp-nosed bullets intended to be used in these rifles at extremely high velocity. Rifles firing these bullets at 2700 feet per second and upwards have been found to be extremely effective on large game. The explosive effect is retained, even increased over the full-jacketed bullet, and there is no longer the tendency to glance. Undoubtedly such bullets are the big-game missiles of the future. At the same time we find that the old principle holds true, that the light, short bullet is liable to be deflected or to go to pieces on a very large, heavy bone, and fail to do its damage in the vitals, while the heavy bullet smashes right through in the direction in which aimed. It is my opinion that in .30 caliber, the 150-grain, sharp-pointed, expanding bullet is a little too light for such game as moose and large bears, and that much better success will be had with a similar bullet of 170 or even 180 grains. A .30-caliber, expanding, pointed bullet of 170 grains, driven with a muzzle velocity of 2700 feet per second, is certainly a most killing and satisfactory charge for all game found in North America, and experience has shown that it is also excellent on all African game with the exception of elephant, buffalo, rhinoceros, and hippopotamus. These largest of all living animals require a much heavier rifle, and the experience of African hunters has shown that nothing less than a .40-caliber rifle, shooting a 400-grain bullet at 2000 feet per second can be considered as suitable for such game, and the standard weapon for such hunting has come to be a .450 or .465 rifle, shooting a 450-grain, jacketed bullet at from 2000 to 2200 feet per second. Such rifles are almost always double barreled, and are made in England.

In the last two years there have appeared on the market several rifles of extremely small bore (.25 caliber), shooting light bullets varying from 86 grains to 123 grains, and with velocities running from 3000 to 3300 feet per second. It is claimed that the explosive effect of such rifles is so great that they are suitable for *all* American game. I have tried such rifles on deer and am willing to accede to their killing qualities on such game, but I have my serious doubts as to their suitability for our largest game. There seems to be a desire, almost a madness, among some hunters (I will not call them sportsmen) to seek after the lightest and smallest bore rifle possible. It always seems strange to me that this is so, but it is undoubtedly a fact. I would like to go on record as being strongly opposed to the use of such arms on game larger than deer from a humanitarian point of view. Such a course is bound to cause much needless suffering. I grant that such rifles will kill quickly if the bullet chances to penetrate intact into the chest cavity

near to the heart, but this is not possible half the time with such arms because they have not the penetration. The bullet explodes when it hits, it fails to penetrate through any amount of tissue. It causes a bad wound where it hits, but the striking point is not half the time in such a location that the damage will reach into the chest cavity and to the heart, and when such is not the case there is inflicted an extremely painful, dangerous wound which does not at all cripple the beast at the time, but which usually causes death after some days of extreme suffering. A man who will hunt moose and elk with a 6-pound, .22-caliber, high-power rifle has very little regard for the suffering of dumb beasts; at least so it seems to me, and the .25 caliber is going it only a little better. On the other hand, we know that rifles like the .30 caliber using a 170-grain bullet at 2700 feet per second, and the .405 Winchester, will, nine times out of ten, if the game be hit fairly near a vital point, and eight times out of ten if it be hit anywhere in the chest or abdominal cavity, kill almost instantly. The game does not suffer, and the conscience of the hunter is as clear as it can be.

There has come in recent years a tendency to regard the energy of a cartridge as a correct measure of its killing power. I do not share in this belief. Only when the weight, shape, and construction of the bullet is the same would this hold true. Energy itself is no indication of the killing power. The .250 Savage high-power cartridge has a velocity of 3000 feet per second and uses an 87-grain bullet. Its muzzle energy is 1740 foot pounds. To say that this cartridge is as good, better, or anywhere near as good a killer on big game as the .45-70-500 cartridge with its energy of only 1602 foot pounds is to my mind simply ridiculous.

I append herewith my own opinion as to the killing qualities of a number of our cartridges. This list is the result of my experience of twenty-five years of hunting. I have talked this matter over with a number of sportsmen of international reputation, and also with a number of guides of great experience in game shooting, and have found that almost invariably their experience leads to exactly the same conclusions as mine. The cartridges are divided into several classes according to the class of game they are suitable for, and they are given in each class in what I consider their relative degree of killing power at ranges under 200 yards, beginning with the most powerful. The numbers in parenthesis give the relative degree of killing power (opinion) at ranges exceeding 200 yards. The figures after the name of the

cartridge are the bullet weight, the muzzle velocity, and the muzzle energy. The letter "S" after the name of a cartridge indicates that it is a special, hand-loaded cartridge, and cannot be procured from factories loaded to secure this ballistics (these cartridges are described in the chapter on "Cartridges"). An asterisk (*) after the name of a cartridge indicates that it is not recommended for shots at a range of over 150 yards.

CLASS I

The following cartridges will be found perfectly satisfactory for all American game, including Alaska brown bear, grizzly bear, and moose. They are needlessly powerful, but otherwise perfectly satisfactory for deer.

	Gr.	Ft. per second	Ft. lbs.
(5) .405 Winchester	300	2,204	3,236
(2) 9 mm. Mauser (S)	280	2,200	3,009
(1) .30 Model 1906 (S)	170	2,700	2,752
(6) .35 Winchester Model 95	250	2,200	2,687
(3) 8 mm. Mauser	236	2,129	2,375
(4) .30 Model 1906	220	2,204	2,374
(7) 9 mm. Mauser	280	1,850	2,090
(8) .45-70 United States government	500	1,201	1,602

CLASS II

The following cartridges will be found perfectly satisfactory for all American game except perhaps Alaska brown bear, grizzly bear, and moose. On these three species they can not be relied upon to give a large percentage of clean kills with the first shot.

	Gr.	Ft. per second	Ft. lbs.
(1) .30 Model 1906	150	2,700	2,428
(2) .30-40 Krag	220	2,000	1,950
(3) 7 mm. Mauser	175	2,300	2,056
(4) 6½ mm. Mannlicher	157	2,313	1,960
(5) .33 Winchester	200	2,056	1,877
(6) .35 Remington auto.	200	2,000	1,776
.45-90 high velocity*	300	1,992	2,644
.45-70 high velocity*	300	1,888	2,375

CLASS III

Deer cartridges. Often used for larger game, particularly by professional hunters, trappers, and Indians, but larger game than deer usually requires a number of shots to kill. This class are popular on account of cheapness, weight, and rifles and ammunition can be procured almost anywhere.

	Grs.	Ft. per second	Ft. lbs.
(1) .303. Savage	195	1,952	1,658
(3) .32 Winchester special	170	2,112	1,684
(3) .32 Remington auto.	170	2,112	1,684
(2) .30-30 Winchester	170	2,008	1,522
(2) .30 Remington auto.	170	2,020	1,540
.401 Winchester auto.*	250	1,875	1,952
(9) .250 Savage	87	3,000	1,739
(4) .38-55 high power	255	1,700	1,635
(5) .32-40 high power	165	2,065	1,538
(6) .38-55 high velocity	255	1,593	1,437
(7) .32-40 high velocity	165	1,752	1,124
(8) .35-55 regular	255	1,321	988
.44 Winchester *	200	1,300	751
.351 Winchester auto.*	180	1,861	1,385

CLASS IV

Varmint cartridges. Suitable for coyote, fox, woodchuck, Western ground squirrel, etc.

	Grs.	Ft. per second	Ft. lbs.
(1) .25 Remington auto.	117	2,127	1,175
(2) .25-35 Winchester	117	1,978	1,175
(3) .25-36 Marlin	117	1,855	803
.22 Savage high power *	70	2,700	1,132
(4) .32-40 regular	165	1,450	770
(5) .28 Stevens	120	1,405	526

CLASS V

Squirrel and turkey cartridges. Also suitable for smaller varmints.

	Grs.	Ft. per second	Ft. lbs.
(1) .25-25 Stevens	86	1,551	459
(2) .25-20 S. S.	86	1,468	412
(3) .25-21 Stevens	86	1,440	396
(4) .25-20 repeater	86	1,376	362
(5) .22 Winchester C. F.	45	1,541	237
.25 rim fire *	67	1,180	208

CLASS VI

Grouse cartridges. Will kill grouse neatly without mangling.

.25-25 Stevens }
 .25-20 S. S. and Rep. } { When loaded with light, sharp pointed
 .25-21 Stevens } { bullets weighing about 77 grains, and
 with a light charge of powder.

	Grs.	Ft. per second	Ft. lbs.
.22 Winchester C. F.	45	1,541	237
.25 rim fire *	67	1,180	280
.22 Winchester rim fire *	45	1,107	122

CLASS VII

For indoor gallery shooting, rats, and English sparrows.

	Grns.	Ft. per second	Ft lbs.
.22 long rifle rim fire *	40	1,103	108
.22 short rim fire *	30	900	54

Many American cartridges have been omitted from this list because they are seldom used and have almost become obsolete. The reader should also consult the chapter on "Cartridges" in connection with this list.

In many cases the point of view of the sportsman very properly enters into the choice of a cartridge. For example: Perhaps a sportsman has been longing for years to take a moose hunt. At last the time comes when he can get away from business. The hunt will cost him, say, \$500. On this trip he may get just one chance at a bull moose, and it is perhaps the only trip he will get in years. The success of the trip depends greatly on his getting the coveted trophy, and everything possible should of course be done to insure the success of the trip. He has, we will say, a .33 Winchester rifle. It would appear foolish for him to risk the success of this trip by using this rifle when for about \$40 additional he can procure a rifle like the .405 Winchester, with which the chances for a successful kill, particularly if he should get but one shot, are so much greater.

On the other hand, a man who has already killed every species of American game can afford to be independent. The procuring of a trophy is no longer absolutely necessary to the success of the trip. I believe that such a man will obtain more satisfaction from an "all-around" rifle of fine accuracy, one like the .30-40 Winchester single shot, which will shoot both high power and reduced loads with great accuracy and with practically the same sight setting. With such a rifle he will take pride in skillful stalking, and in clean kills with the first shot, and such kills will bring him as much satisfaction as did his first, well-earned trophies.

We find that throughout the whole of northern Canada, except perhaps in Yukon Territory, the .30-30 Winchester is the most popular rifle, and is almost always seen in carbine form. There are several reasons for this. The rifle and cartridges are the cheapest of the high-power variety. Almost all dealers carry them in stock. In the far north the Hudson Bay Company and its rival traders handle only this

rifle and cartridge. The ammunition can be obtained anywhere, whereas ammunition for other rifles is extremely hard to get at any price. The preference of the carbine is indicative of the power of this cartridge. For large game several shots are almost always necessary to kill, and a carbine is handier and quicker for rapid fire, particularly in brush, than the rifle with longer barrel.

THE CALCULATION OF ENERGY

In connection with killing power, the rifleman may wish to calculate the energy of a certain cartridge. To calculate the energy of any load is very simple. The formula is:

$$E = \frac{W V^2}{2 g}$$

in which E equals the energy in foot-pounds, W equals the weight of the projectile in pounds, V equals the velocity of the projectile in foot-seconds, and G equals the acceleration of gravity or 32.16.

Example: Given a 200-grain bullet having a muzzle velocity of 2000 feet per second, to find the muzzle energy, from the above formula we have:

$$E = \frac{200 \times 2000 \times 2000}{7000 \times 2 \times 32.16}$$

The 7000 is introduced to reduce the grains weight of the bullet to pounds. To work out the above we have:

```

2000
 2000
-----
4000000
  200
-----
800000000
    
```

```

7000
  2
-----
14000
 32.16
-----
 84000
 14000
 28000
 42000
-----
450240.00
    
```

$$800000000 \div 450240 = 1776.8$$

$$E = 1776.8 \text{ foot-pounds.}$$

To simplify this simply multiply the velocity by itself, and then by the weight of the bullet, and divide 450240 into the result. For muzzle energy use the muzzle velocity, and for energy at any other range use the remaining velocity at that range.

CHAPTER XVI

ELEVATION

THE elevation of a rifle is the sight setting required to cause the rifle when correctly aimed to shoot very close to a horizontal line drawn through the center of the bull's-eye or through the point of aim. A rifle is said to hold its elevation well when the vertical dispersion is small, and when the sight setting required for a certain range does not change appreciably from time to time.

It is the custom to set the sights of target and military rifles so that when aimed a slight distance below the bull's-eye the shots will strike around the center of the bull's-eye. As the sights are black and the bull's-eye is also black, it has been found that in aiming out-of-doors in various lights the sights and bull's-eye often blend together, and if one tries to aim at the center of the bull's-eye in practice it is not possible to see well enough to tell if he is actually aiming at the center, the top, or the bottom. But if one aims just below the bull's-eye the black sights are silhouetted against the white portion of the target and the bull's-eye appears like a black ball balanced just above the center of the front sight. In instructing a novice to aim he is told always to see the same amount of white target between the top of his front sight and the bottom of the bull's-eye in order that his elevation may be constant. As one gains more experience, however, he realizes that accurate aiming consists more in duplicating exactly each time the "picture" of the sights and target. The retina of the eye seems soon to acquire a memory for this picture and to be able to duplicate it each time with surprising accuracy. If the "picture" does not look right, the eye at once tells the brain, and the aim is corrected.

With a hunting rifle the best practice is so to sight it for each range that the shots will strike close to where the top of the front sight is held. This is much more satisfactory for game shooting. Thus with a target rifle sighted for, say, 200 yards on an 8-inch bull's-eye, the rifle will actually shoot half the diameter of the bull's-eye high (4 inches) plus the distance that it is aimed under the bull's-eye (say 3 inches), or 7 inches above the point where the top of the front sight is aligned on the target. This is correct for 200-yard target shooting, but it is

manifestly unsatisfactory for game shooting as one should not be required to estimate a certain amount to hold under on a target which never looks the same twice. If we sight our hunting rifle to strike where the top of the front sight is held at a range of 200 yards, and we then use this rifle for target shooting at that range, aiming it below the bull's-eye as the target shot does, then the rifle will strike below the bull's-eye. As we usually sight our hunting rifles in on a bull's-eye target we should take this into consideration, and if we use the target shooter's method of aim on this target we should so adjust our sights that in aiming in this manner the shots will strike not into the center of the bull's-eye, but just below the bottom of the bull's-eye.

There is no such thing as "point-blank range," for the bullet begins to fall to the ground as soon as it leaves the support of the barrel. But every rifleman must determine the shortest range to which he wishes his rifle sighted. For the military shot this will probably be about 200 yards, as with a rifle of modern velocity sighted thus if he aims at the bottom of an 8-inch bull's-eye, or at the bottom of an enemy's head appearing above shelter, he will hit that bull's-eye or head somewhere surely anywhere between the muzzle of the rifle and about 225 yards. The target shot will of course have his rifle so that the sights can be lowered just low enough to hit the bull's-eye with a target held at the shortest range at which he will ever want to shoot. The hunter should have his sights so set that he can adjust them low enough for what we will call the "small-game elevation"; that is, say, for 15 yards, so that he can hold on the head of a grouse or squirrel at this close range and be sure of decapitating it. Or perhaps it may be the head of a woodchuck or coyote just showing in the grass a few yards off. Then he should also have the sights plainly marked for what we will call the "big-game elevation." If we take the vital portion of the body of a big game animal to be at least 8 inches in diameter, then this range for the big-game elevation should be that at which the rifle, when aimed at the center of this 8-inch circle, will shoot neither above or below the circle at intermediate ranges. Thus, if the rifle when fired at 200 yards has a rise in its trajectory at 100 yards of 4 inches, we can sight it for 200 yards. It will then strike the center of the bull's-eye at very short ranges, and the bullet will then rise gradually in its flight until if the game be at 100 yards the bullet will just strike the top of the 8-inch circle. At 200 yards the bullet will of course strike center, and at, say, 225 yards it will have fallen so that it will strike the bottom of the 8-inch circle, the aim in every case being taken at the center of the

circle. Thus, with this big-game elevation, this rifle is good for a shot in the vitals of a large animal up to 225 yards without its being necessary to estimate the range at all. Most hunters prefer to leave their sights always at this big-game elevation when hunting large game, and, if the game appears to be farther off than the big-game elevation, aim will be taken higher up on the body of the animal instead of at the center of the vital organs. In practice this usually works better than trying to estimate the range and set the sights. There is seldom time in game shooting to set the sights, and as the ranges in game shooting practically never exceed 400 yards this method works very well.

A rifle should always be sighted in; that is, targeted, and the sights adjusted, by the person who is going to use it. It is a fact that two men seldom can use the same sighting with a rifle. A rifle correctly adjusted for a certain man at a certain range will seldom be found exactly correct for another man at the same range. So also a rifle which is supposed to be correctly adjusted for a certain range at the factory will seldom be found to be correct for the purchaser. This is chiefly due to the differences in aiming and holding the rifle between different men, also to different conditions pertaining between the time that one man adjusts the rifle for himself and when the other man uses it. Thus one rifleman may take a rifle and adjust the sights absolutely correct for himself for 200 yards, and then hand it to another to try. The second man may find that it shoots as much as 8 inches off the mark when he aims in his normal manner. It is therefore evident that every man should sight his own rifle, and not leave it to some one else or the factory to do.

It is very easy slightly to injure a rifle so as to change its sighting considerably. Particularly the rifle should never be allowed to fall, as either the sights may be knocked out of alignment or the barrel may even be bent. The muzzle of the rifle should be guarded carefully against injury, and also precautions should be taken to see that it receives no wear from the cleaning rod in the process of cleaning. If the sharp corners of the lands and grooves are worn or deformed at the muzzle, there will be a considerable change in the sighting of the rifle. A worn or deformed muzzle does not necessarily mean a loss of accuracy, but it does mean that a rifle will shoot a considerable distance from its normal sighting.

A rifle will require a very slight change in elevation from time to time. When it is new it changes a little during the first 100 shots or so when the bore is losing the polish of the tools with which it was

made, and taking on the polish it receives from the bullets passing through it. Also during this period the barrel is being pounded down to a set position in its stock. It is very necessary to see that the screws which secure the stock to the action are always kept screwed up as tight as possible. If these become loose the rifle will shoot very raggedly. Also in the case of a military rifle, which has a long forearm extending up almost to the muzzle, it is absolutely necessary to see that the wood under the bands which secure the forearm to the barrel does not bind and interfere with the expansion of the barrel as it gets hot from firing. If the wood binds and interferes with the free expansion or lengthening of the barrel, which always occurs when it becomes hot, the rifle will shoot very poorly and no accuracy can be expected. This must be particularly looked into if the rifle is taken from a dry climate into a damp one, as the wood of the forearm will always swell greatly.

The accumulation of metal fouling in the bore from firing will often cause a change in elevation. With good ammunition and a fairly smooth barrel, enough metal fouling will seldom be accumulated in a day's shooting to cause trouble, but the rifle should always be treated with the ammonia bath at the end of every day's firing. This applies, of course, only to rifles of high velocity, using metal-jacketed bullets.

Other conditions which may influence the elevation from day to day are as follows:

Temperature. On a hot day the rifle will shoot high and will require a slightly lower elevation. The reverse pertains on a cold day. Ammunition which has been allowed to remain exposed to the sun long enough to get very hot will also shoot high. Some powders are considerably influenced by temperature. Foreign powders are particular offenders in this respect. Our own Du Pont powders are influenced very slightly if at all by ordinary heating or by extreme cold, and it is only when they are allowed to get very hot, as when exposed for a long time to powerful sun, that they will cause an appreciable change in the velocity of the charge. It has been found that with our .30-caliber Model 1906 service ammunition a degree of temperature will change the velocity 1.5 seconds. Translating this into elevation we find that a 20 degree change in temperature will change the elevation by 1.093 minutes. The normal elevation is 70 degrees F. Thus if one has his sight correctly adjusted for elevation for a certain range for 70 degrees temperature, and on the day of firing the temperature stands at 90 degrees the elevation should be decreased about 1 minute of angle.

Barometer and hygrometer. The density of the air varies with the barometer and hygrometer readings. It has been found that the lower the barometer and the higher the hygrometer, the higher the rifle will shoot, and the less will be the elevation required. We obtain the greatest change in barometer when we go from a very high to a low elevation, or *vice versa*, as for example when we take a rifle sighted in at sea level to the high mountain country. At high altitudes the rifle will shoot higher than it does at the sea level, and this must be taken into consideration in some cases where the change is very great.

As a general rule the changes in elevation caused by differences in thermometer, barometer, and hygrometer are so slight that they do not have to be taken into consideration, particularly at short ranges. Occasionally, however, these factors must be watched as they sometimes combine in such a way as to make quite a change in elevation necessary, as, for example, when we have a very high temperature combined with a low barometer and a very strong rear wind, or when we have a high temperature at high altitude. The influence of these factors seems to be very much less with rifles of very high velocity (over 2500 feet per second) than with rifles of low or medium velocity. This is one of the advantages which accrue from a very high velocity.

Mirage. Mirage or heat waves, make the target dance or simmer. The atmosphere seems to boil. The target appears blurred and the blurred bull's-eye looks larger than when seen in a clear atmosphere. In trying to aim at the correct distance below the bull's-eye, the rifleman naturally aims a little lower on the blurred bull, hence when mirage is present a slightly greater elevation will be required. Ordinary mirage does not displace or "drift" the image of the target.

Light. Changes in the light make very little difference in the elevation, if a peep or aperture sight be used. If the sun be shining brightly from high up in the heavens the top of the front sight will be brilliantly lighted, and no matter of what material it is made it will cast a slight glimmer. Some sights of course cast more glimmer than others, the worst offenders being those with silver beads and bevelled beads. The best are the dead black military sights and those ivory bead sights which present a perfectly flat, perpendicular surface to the eye. This glimmer prevents one from holding as near to the target as he would if there were no glimmer and the sights were clearly defined. It is seldom that one is conscious of this glimmer with a good front sight, but it is always there and causes the effect noted. Therefore, as the front sight is not held quite so high the shot will strike lower, and more elevation

will be required. Usually, with good sights, this effect is hardly noticeable, particularly if one is wearing amber-colored spectacles. With dead-black (well-smoked), military sights, using the peep sight, and with amber glasses, it appears to cause a change in elevation of just about one minute of angle. That is to say, about one more minute elevation will be required when there is a bright sun overhead than when the front sight is shaded or the day is cloudy. The sun shining on the side of the front sight also has a lateral effect of just about the same amount. With the military peep sight and sights well blackened by smoking with camphor smoke, it has been found that when shooting to the north or south in the morning when the sun shines brightly on one side of the front sight it illuminates that side and one naturally favors that side in aiming, hence the rifle will shoot away from the sun, and the difference under these conditions between shooting when the sun is shining brightly and when it is covered with a dark cloud is just about one minute of angle. As one minute of angle equals 1 inch per 100 yards this would amount to 2 inches at 200 yards. In the afternoon when the sun lights up the other side of the front sight it will cause just as much of an error in the opposite direction, so that the difference between morning and afternoon shooting on a north and south range when the sun is shining will be just about 2 minutes of angle with dead black front sight and peep rear sight. With the open sight light sometimes has considerable effect on the elevation; but it seems to differ with individuals, probably depending upon the strength and vision of the eyes. It also follows the principle that the best-lighted portion of the sights will be unconsciously favored in aiming, and when using the open sight the light has a chance to shine into the notch of the rear sight and considerably complicate matters. The light will thus affect each individual so differently that it is not possible to prescribe any rule, and each rifleman must find out his own personal equation as regards light when shooting with open sights.

Ammunition. Differences in lots of ammunition sometimes make considerable change in elevation necessary when changing from one lot to another, and particularly when changing from one make to another, even when the two makes are practically identical as to bullet and powder charge. This is due to several causes, such as difference in velocity between lots of the same powder, differences caused in the cartridge by different loading machines, difference in the length of time that the cartridges have been loaded, etc. Ordinary commercial hunting ammunition will show a much greater difference in this respect be-

tween lots than does standard military ammunition, as much more pains is taken in loading the latter class of ammunition to get uniformity, even to blending the powder and making careful velocity tests with each lot of powder before determining exactly how much of that lot will be loaded in the shell. It is always best, if one wishes uniform results, to buy his ammunition in large lots. Ammunition is usually packed in boxes of from 1000 to 2000 rounds each. If it is not desired to buy as much as this at one time, specify that all that one does buy shall come from one of these large boxes, and not from two or more, as one box is pretty sure to contain only the loading from one machine, and one lot of powder on one day, and thus be uniform. Errors from this cause are really important as they sometimes amount to as much as four or five inches at one hundred yards.

Winds. Head winds, that is, those blowing from the target towards the marksman, retard the bullet and require additional elevation. Rear winds require a lower elevation. The effect of these accelerating and retarding winds at ranges up to 1000 yards is very small and scarcely ever need be taken into account.

Positions. The position assumed by the rifleman when firing influences the elevation considerably. In the military prone position with tight gunsling, the rifle shoots lower than when held in any other way, but probably shoots more consistently as the military shot, when firing prone, learns to hold the rifle exactly the same for every shot, to get the same amount of pressure on the sling each time, and always to receive the recoil on the shoulder in the same manner. In target shooting, however, where one holds the top of the front sight under the bull's-eye there is little difference in shooting at a bull's-eye target between the elevation required for the prone position and that required for offhand or standing shooting, because in the latter position one does not hold as steadily, and thus naturally holds a little lower, with a little more of the white target showing between the top of his front sight and the bottom of the bull's-eye, so that he can get a clearer view of the bull's-eye as his sights bob and travel over the face of the target. When firing with a sand bag rest or other rest under the barrel of the rifle, the rifle shoots high and requires a lower elevation. The reason for this is fully explained in the chapter dealing with Zero Elevation, Barrel Flip, and Resting the Rifle.

Condition of bore. If the bore be heavily coated with a thick grease, like the gun grease usually sold, or with an oil like thick cylinder oil, the first shot will fly high and wild, and it will take several shots to shoot

all trace of the oil from the bore and get the rifle shooting with its normal elevation. Light oils, like sperm oil or "3 in 1," do not have this effect, and if the bore be free from heavy oil the point of impact of the first shot from a clean, slightly oily bore and the succeeding shots will be practically the same. This is not true with .22-caliber rifles and those using black powder, as in such cases the first shot from a clean bore will strike the target slightly higher than the succeeding shots. Sometimes a rifle using jacketed bullets and having a very high velocity will pick up enough metal fouling during a score to cause a change in the elevation, but this is practically never the case unless the bore has been so neglected as to become very rough and pitted.

When reading the above over the rifleman must not get the idea that it is necessary to take all these matters into consideration when about to fire a score at the target. As a general rule elevation is influenced very little in the numerous ways just cited, because a change in one condition is usually offset by a change in some other condition, and with a good rifle, good sights, and uniform holding and aiming on the part of the rifleman there will be very little difference in the elevation from day to day, scarcely enough ever to be taken into consideration from a practical point of view.

The average elevation necessary at a given range in good weather conditions is called the "normal elevation" for that range. The normal elevation should always be used for the first shot, unless the conditions clearly indicate that a change is advisable.

CHAPTER XVII

ACCURACY

ACCURACY, in a rifle, may be defined as that quality which will permit one to fire a number of consecutive shots at a given range into a small circle or group, and also that quality, which on a succeeding attempt, all conditions being the same as the first attempt, permits a practical duplication of results. In other words a rifle, to be called accurate, should deliver a series of consecutive shots, fired with the same aim, into a small group; and it should be possible at any time (sight adjustment, range, and weather conditions being equal) to duplicate the result of the first group both as to size and point of impact.

As to the size of the group that a rifle should make at various ranges to be considered accurate, I cannot do better than quote the "British Text Book of Small Arms" (official publication) in this respect: "The group of shots made by a good rifle is approximately circular, and at short ranges all the shots should be contained in a circle subtending about 3 minutes at the muzzle, the bulk of them being well in the middle of it." Since 1 minute subtends practically 1 inch at 100 yards, this gives us a 3-inch circle at 100 yards, a 6-inch circle at 200 yards, a 9-inch circle at 300 yards, a 15-inch circle at 500 yards, etc., as being the size which the group should not exceed at the various ranges to entitle the weapon and ammunition to be classed as accurate.

Not all rifles are designed to shoot accurately to as long a range as 500 yards. In fact a large number of sporting rifles are not designed to be accurate beyond 150 yards. Thus a .401 auto-loading rifle may be classed as accurate because on testing it is found that it will group its shots consistently within a 2½-inch circle at 100 yards, whereas if this rifle were tried at 200 yards it might take a 25-inch circle to hold its shots, and at still longer ranges its shots might fly all over the landscape. The novice is apt to expect too much from a rifle, and it is as unfair to expect a short-range weapon to perform well at long ranges as it would be to expect a shotgun to do good execution at 100 yards.

Accuracy is the most important quality in a rifle. If the rifle is inaccurate, it is worthless. It must certainly be as accurate as the

marksman can hold and aim, as he will never be content with a weapon which in itself limits his skill. A trained marksman can hold for a 6-inch group or slightly better at 200 yards, and if his rifle will not give him this he determines that it is inaccurate and discards it.

It is not always fair to condemn a rifle as inaccurate because on trial



Fig. 86

Mann chronograph on Dr. Mann's first testing range

it fails to come up to the above requirements. Accuracy depends not only on the rifle but on the ammunition as well, and many an accurate rifle has been condemned simply because of poor ammunition. Moreover, it may be remarked that very few riflemen are capable of testing a rifle for accuracy. In fact I may state that it is my belief that there are not a hundred riflemen in the United States capable of making a reliable accuracy test of a rifle without resorting to a machine rest.

Accuracy in rifle and ammunition depend on a great many factors, and it is my purpose in this chapter to consider the most important of these factors. To approach the subject understandingly we must have a little knowledge as to the flight of the bullet.

PERFECTION IMPOSSIBLE

If a perfect bullet be delivered from the muzzle of the rifle without mutilation, and with a rotation or spin imparted to it by the rifling sufficient to maintain its gyrostatic stability, that bullet (neglecting wind and atmospheric deflections) will fly perfectly to the target through its path of trajectory; and a series of such perfect bullets, perfectly delivered, would fly exactly the same, perfect accuracy would result, and the bullets would all strike the same point on the target.

Perfect accuracy is, however, unattainable, as it is practically impossible to produce a perfect bullet, and still more impossible to fire such a bullet from a rifle without causing to it a certain mutilation or deformity. Deformities occurring to bullets during manufacture, or upon firing in a rifle, may be divided into three classes: imperfection of form, imperfection of balance, and inequality in weight. In form a bullet may not be round, its point may not be perfect, or its base may be oblique — that is, not at right angles to its longer axis. Due to bubbles in its lead core, variation in thickness of jacket, or some lack of homogeneity in the metal entering into its construction, it may be unbalanced — that is, its center of gravity will not coincide with its center of form.

It is not necessary for the purpose of this discussion to go into an explanation of, or even to enumerate all, the various motions which a bullet may go through in its flight through the air. To do so would require several hundred pages, and it is doubtful if the layman, for whom this book is written, would be able to understand half of it. Instead, it will suffice to see what happens to a bullet with an oblique base, and to an unbalanced bullet, when fired from a good rifle.

THE NORMAL GROUP

We must first have some standard of comparison. Let us say that we are firing with a very accurate rifle from rest at 100 yards. As we produce group after group, gradually they attain certain semblance to each other which we can recognize. Each of the ten-shot groups can be enclosed in a circle of about the same size, say 2.50 inches. Moreover, we see that if we eliminate about two of the wildest shots from each group, the groups could be contained in circles about 1.25 inches in diameter. Hence we get to wondering what causes these two off-shots in every ten. If they could be eliminated the accuracy of our rifle would be doubled. In order to have something with which

to compare the amount of deviation of these off shots, we get to calling the group that our rifle makes minus these shots (the eight-shot group) the "normal group," both as to its size and as to the location of its point of impact relative to the sighting. Thus it will be understood what we mean when we say a bullet strikes so far from normal.

THE TIPPING BULLET

Let us say that we fire from a good rifle barrel a bullet which has had the base made purposely oblique by shaving a small piece off of one side of the base. This bullet, as it leaves the muzzle, instead of gradually merging from the line of axis of bore into the path of the

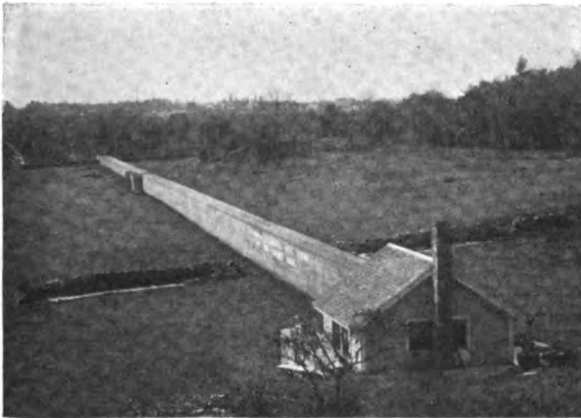

Fig. 87

Dr. Mann's 200-yard covered rifle range

trajectory as a normal bullet would, departs from the bore at a tangent to the line of fire. It "tips" as soon as it leaves the muzzle, or very shortly thereafter. As its base leaves the muzzle, one side leaves before the other, the powder gas rushes out from behind the bullet on the short side first, the long side still retaining contact and friction with the bore, and consequently causing a tip to its longer side, and the bullet continues to fly at a tangent to the line it formerly started on through the axis of the bore. The bullet now flies on this new tangent straight towards the target, so that we will say it hits the target 5 inches to the right of the normal group. Now if we were to place a screen just half way between the target and the rifle, mark thereon where the normal group would pass through this screen, and fire through it with our oblique base bullet we would find that it would print just half of

five inches to the right of the normal group, or $2\frac{1}{2}$ inches, thus showing that the bullet travels in a straight line from muzzle to target, only this straight line is a tangent to the straight line which normal bullets take. If we fire two oblique-base bullets, equal as to their obliquity, but introduce them into the rifle so that one emerges with its cut at an angle of 180 degrees from the other (say one emerges from the muzzle with the cut up, and the other with the cut down), then these two bullets will be almost equally distant from the normal group, but on opposite sides from each other. One may be five inches to the right of the group, and the other five inches to the left of the group.

Since our bullet has been deflected from the line of fire, the line in which it attained its rotation of spin, it follows that it will be forced to gyrate and oscillate instead of flying at all times point true to the line of fire. If we place a series of paper screens at various points between the muzzle and the target on which the bullet can leave its print we will see that it passes through some screens tipping slightly in one direction, through others slightly in another direction, and through some practically point on. If these screens be placed frequently enough, and at regular intervals, we can trace the whole movement of the bullet, can see it take its first tip shortly after leaving the muzzle, can see it make its first gyration, and can measure the distance it has to fly to complete one gyration. Of course it requires a considerable mutilation to the base of the bullet to cause a deflection from normal of 5 inches at 100 yards, but an intentional shave to the side of the base with a pen knife will easily do it, and perhaps much more. A small obliquity to the base which could not be measured by the eye, either existing in the bullet before it was fired, or being caused in the barrel during explosion, would easily cause an off-shot of an inch or so at 100 yards, and two of these, emerging in opposite directions, would of course cause an increase in the size of the group of 2 inches. In this explanation the oblique base bullet only has been considered, and the fact that an oblique base bullet is always of necessity an unbalanced bullet has been disregarded.

THE UNBALANCED BULLET

An unbalanced bullet, as we have seen, is one in which the center of gravity does not conform to the center of form, hence the center of gravity does not lie in the line of axis of bore (line of fire). The bullet may be unbalanced before loading, or it may become unbalanced before it reaches the muzzle. This causes the center of gravity of the bullet

to fly in a spiral around the axis of the bore, and to describe a circle around the center of the bullet's form as the bullet passes through the bore of the rifle. When the bullet is released at the muzzle it no longer is forced to keep its bore spiral, and it takes a straight course which can only be a tangent to that spiral. This can be illustrated by swinging a weight attached to a string in a circle; as soon as the weight is released by letting go the string it flies at a tangent to the circle it has been describing. This illustration of course greatly exaggerates. If the center of gravity be off the center of form by .001 inch, and the twist of rifling has a pitch of one turn in ten inches, then the bore



Fig. 88

Dr. Mann's 200-yard covered range under construction, showing "V" rest and base already in position

spiral has a pitch of ten inches and a diameter of .002 inch, and the tangent may cause a deflection of an inch or two at 100 yards. Since the bullet is no longer flying in the line of fire, it must gyrate just as in the first instance.

It will be seen from the above that we have two causes for off shots, the oblique base bullet, and the unbalanced bullet, and these two errors are usually present at the same time. If, for discussion, we consider that each error is going to cause the same deflection at the target, it is clear that these two deflections may be added to each other thus causing twice the error, or they may exactly balance each other, thus causing the bullet to print in the normal group. Both errors may thus cause, on one shot, a deflection to the right of 1 inch, and the bullet prints 2

inches to the right of normal. Next shot they may exactly balance each other and a normal print results. The third shot they may both cause an upward deflection and a shot two inches above normal results, so that the final result is a four inch group where the normal group is 1.25 inches. Thus we will see the necessity for eliminating these off-shots if we are to improve the accuracy of the rifle.

IMPERFECTIONS IN BULLET MANUFACTURE

We have seen that a bullet is deformed either before or in the act of firing. If deformed before firing, it may be deformed either in the process of manufacture or by injury after manufacture and before loading. This latter is due to carelessness and will not be discussed. A few years ago bullets were made almost universally of an alloy of lead and tin, varying from 1 part by weight of tin to 16 parts of lead, to 1 part tin to 60 parts of lead. There was considerable chance for imperfection in such bullets. They were liable to bruises either in manufacture or in handling after manufacture, and occasionally small bubbles would be present in the interior of the core which would unbalance them badly. But today bullets are almost invariably jacketed with copper or cupro-nickel, and the process of manufacture has been so much improved, and they are so well protected by the jacket, that the imperfections are very few and minute. In my experiments during recent years I have almost invariably been able to get groups from jacketed bullets about twice as small as I have been able to obtain in the same cartridge from lead and tin bullets. Given a good rifle and ammunition well designed for accuracy, it is my opinion that the modern jacketed bullet, when it is not deformed in the rifle, will shoot steadily into a small normal group. The spreading of this normal group, say 1.25 inches at 100 yards, is due to the small, ineradicable deformities in the bullet, and the off-shots are due to the further deforming of the bullet by the rifle during firing.

With even the best barrels of ordinary manufacture there is an average spreading of groups in the finest target work, averaging two and a half to three inches at 100 yards, not including fortunate groups, or those from special rifles which will be discussed later. These large groups occur in spite of perfect weather conditions, they show up when powder charges are most carefully weighed and every precaution taken, they show up with rests and telescope sights, and when the rifle is cleaned after every shot or shot dirty, when the bullet is seated in the shell or in the barrel ahead of the shell. These groups almost in-

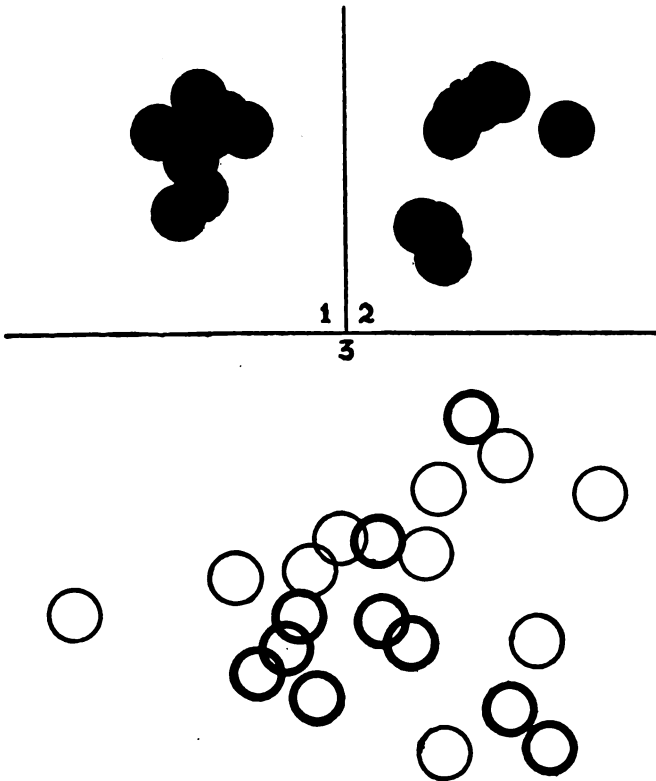

Fig. 89

Groups showing what accuracy a good commercial American rifle and ammunition are capable of. Shot with a .30-40 Winchester single shot rifle equipped with Winchester telescope sight and fired from muzzle and elbow rest. Groups are reproduced exact size.

No. 1. 10 shots, 50 yards, Rem.-U. M. C., 220 grain soft point. Best group.

No. 2. 10 shots, 50 yards, Peters 220 grain soft point. An average group.

No. 3. Heavy circles. 10 shots, 100 yards, Rem.-U. M. C. 220 grain soft point. Best group.

No. 3. Light circles. 10 shots, 100 yards, W. R. A. Co., 220 grain soft point. An average group.

variably show 80 per cent. of the group in a small "normal group," and the other 20 per cent. of the shots "off-shots" which about double the size of the group. Thus we are again brought face to face with the fact that if we are to increase the accuracy we must discover the cause for these mutilations of the bullet by the rifle. In any group 80 to 90 per cent. of the spreading is due to bullet deformation, either before or during firing, and the other 10 or 20 per cent. is due to trajectory,

and this latter small error must always be present, since it is against all probability that any ammunition can throw every shot with absolutely the same velocity. The powder charge and the perfection and speed of ignition by the primer are bound to vary slightly.

IRREGULARITIES IN BORE

We must now inquire into what occurs to the bullet when it is fired in the rifle, from the time it is seated in the chamber until it leaves the muzzle of the rifle, and in this connection we must consider the bore of the rifle. It is not an easy matter to bore a rifle absolutely straight. To do so requires considerable time and much hand labor of the most skilled kind. This is not attempted by any of the large rifle factories. They try so to perfect their methods of manufacture at high speed by machinery as to insure getting the bores almost straight, and they succeed very well in doing so, only slightly missing perfection. The barrel, after being smooth bored as straight as possible, is then straightened. This is done by a workman called a barrel straightener. He holds the barrel up towards the light, and by looking through it at a line against the light, certain shadows are seen in the bore. By these shadows he determines whether the bore is straight or not, and if crooked he tells where the imperfection occurs. He then proceeds to straighten the bore by striking it blows with a lead hammer until the shadows indicate that it is straight. There is a great deal of guess work about this. In fact the modern expert in rifle construction is fast getting to believe that it is all guess work, and had much better be left undone. A straightened barrel is liable, after being finished, and during the firing and consequent heating up, to go back to its former crooked state, and of course to alter its shooting. In my own experience I have had barrels which have done this. I had one .30-caliber government barrel which shot very well indeed for about 600 rounds, then it suddenly changed its zero about half a point (2 inches at 100 yards) and for a couple of hundred rounds it kept constantly varying from its old to its new zero so that I could never tell in advance just where it was going to place its group. Finally it gradually retained its new zero. It is the present opinion among rifle shots that slight imperfections in straightness will not hurt the shooting of a rifle to a serious degree, except that a crooked barrel will have a shorter accuracy life than a straight barrel, and in consequence many manufacturers have ceased to straighten their barrels, preferring to leave those barrels that are not perfectly straight in that condition. Bar-

rels that have been straightened often develop another very undesirable trait. They are liable to throw their shots farther and farther off in some direction as they grow warm from firing. I once had a Krag .30-caliber rifle which required that the elevation be dropped two minutes after every shot in order to keep it shooting into the bull's-eye at 1000 yards.

The bore should be absolutely uniform in caliber from breech to muzzle. Particularly there should be no tight or loose places in the bore. A very slight and gradual tightening of the bore from breech to muzzle will do no harm, but it is also no advantage with jacketed bullets, although this form of bore is a part of the Pope muzzle-loading rifle and necessary with that system.



Fig. 90

Single shot bolt action rifle, .25 caliber, velocity 3,400 feet per second, 200-yard trajectory 1.60 inches, bullet weight 104 grains, made by A. O. Neidner

After the barrel is smooth bored, it must then be rifled. This operation must be well done, leaving a smooth, perfect cut, with no rough places. Otherwise the barrel is very likely to pick up lumps of fouling from the bullet, thus both deforming that bullet and the bullet that follows, and making the bore very difficult to clean. One of our barrel makers (Pope), before rifling his barrels, goes over it with a fine cutter and polishing tool giving to them the same motion and twist that he will afterwards give with the rifling machine. He thus polishes them in exact line and twist with the subsequent rifling, insuring particularly that there shall be no tool marks in the bore at right angles to the bullet. Such a barrel shoots beautifully and is extremely easy to clean, as practically no fouling adheres to the bore.

SIZE OF BORE

We must now consider what the size or caliber of the bore should be in relation to the diameter of the bullet. A rifle barrel has two diameters: the diameter of the smooth bore before it is rifled, which in a finished barrel will be the diameter from the top of one land to the top of the opposite land, called "bore diameter" or "land diameter"; and the "groove diameter," being the diameter from the bottom of

one groove to the bottom of the opposite groove. Thus a .30-caliber rifle is usually smooth bored .300 inch, and then rifled .004 inch deep, making its bore diameter .300 inch and its groove diameter .308 inch.

The groove diameter of the barrel should be exactly the same as the largest diameter of the bullet. At least there should not be a difference as great as .0002 inch in the diameter of the two. This differs considerably from the standard of some manufacturers. Usually they

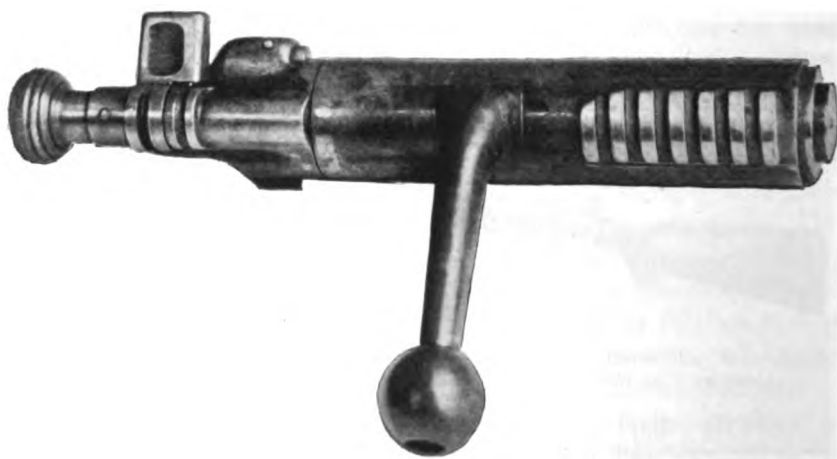

Fig. 91

Bolt used in Neidner single shot, high power, bolt action rifle

prefer to make their groove diameters about .002 inch larger than the bullet, depending upon the bullet to upset and fill the bore. The bullet does do this after a fashion, but as we will see later it deforms itself in doing it, and right here we find one of the reasons for the off-shot. Also, as will be seen later, the jacketed bullet does not upset and fill the bore at once, and the large groove diameter and small bullet are a fruitful source of gas cutting (usually called erosion), and the life of the barrel is thereby shortened. The reasons for making the groove diameter slightly larger than the bullet are several. First, the breech pressure is lessened; and second, the allowance automatically takes care of rusted and dirty barrels. As regards the first reason it may be said that the breech pressure is lessened because some of the powder gas escapes ahead of the bullet, thus a loose bullet requires more powder than a tight one to produce the same velocity.

Neither should the groove diameter be less than the size of the bullet, as this would mean that the barrel must actually swedge down

the bullet when it is fired, and a deformity would most certainly occur in this form of swedge. I have in my possession such a barrel which measures .308-inch groove diameter and which fires a bullet measuring about .310 inch. It is interesting to note that this barrel scatters its shots most awfully the first four or five shots, but that after the barrel becomes warmed up it shoots very well, giving about 2.50-inch groups at 100 yards.

We are now able to prescribe certain requisites as regards the bore of the rifle which must be followed in order to insure against the bore deforming the bullet as it passes through it. The bore and rifling should be smooth, the bore should be of uniform diameter, containing no tight or loose places, and the groove diameter should be exactly the same as the bullet diameter.¹

THE CHAMBER

All commercial and military rifles are made with a certain clearance or tolerance in the chamber so as to take care of small differences in the size of shells and bullets, and also of a certain amount of dirt and rust; it being very desirable that the shell shall be easily inserted in the chamber by the breech mechanism without undue force having to be used, and also that after having been fired it shall not stick in the chamber, but shall be easily extracted without undue force having to be applied to the breech mechanism. The .30-caliber United States magazine rifle, Model 1903, has a clearance of about .003 inch at the neck of the chamber to take care of these factors; that is, to say the diameter of the neck of the chamber where the neck of the shell rests is about .003 inch larger than the neck of the standard cartridge, and the other portions of the chamber are likewise slightly larger than the standard shell. I have in my possession three special .30-40 target barrels of Winchester make which show a similar clearance of about .002 inch at the neck. Some chambers that I have measured show a clearance of as much as .005 inch.

It will be apparent to any one that a cartridge lying in such a chamber will not lie in the exact center of the chamber, but due to gravity it must lie at the bottom of the chamber. The bullet will therefore not be in line with the axis of the bore when the explosion of the powder takes place. With many chambers the throat of the chamber is so arranged that the forward portion or shoulder of the bullet abuts up against the

¹ This applies only to the modern high-power rifle using a jacketed bullet, and does not apply to lead-alloy bullets used in high-power rifles, this being a special case which is treated elsewhere.

throat of the rifling when the cartridge is inserted and the breech closed, but this can only help matters a little since the breech of the cartridge must still lie in the bottom of the large chamber, and the base of the bullet will then be below the axis of the bore, the longer axis of the bullet pointing upward. It therefore follows that the bullet cannot be in line with the axis of the bore before being fired if the chamber be of the commercial variety; and that the larger the chamber relative to the cartridge, the more the bullet will be out of line. In this connection it is interesting to note that invariably in my accuracy tests of various rifles, other conditions being equal, the tighter chambers gave the best groups.

It will be necessary now to describe what takes place in the chamber of the rifle, particularly to the bullet in the chamber, when the rifle is fired. We must describe this under two heads, lead bullet and jacketed bullet, as the action is very different in each case.

Take first the case of the lead bullet and black powder. When the powder is ignited, the gas strikes the base of the lead bullet a severe blow. The lead bullet is at once expanded or upset to fill completely the neck of the chamber, the neck of the shell of course conforming. The bullet then, at the start, is the size of the neck of the chamber, less of course twice the thickness of the metal of the shell at its neck. Suppose we are firing a .40-caliber, black powder rifle. The bullet and bore both measure .403 inch. The chamber has a clearance of .004 inch at the neck. On firing, the bullet is then first upset to .407 inch, being considerably deformed and very likely made slightly oblique at the base; then the bullet starts forward out of the chamber into the bore, and at once it must be swedged back to .403 inch in the bore, and the rifling must cut into the bullet, this giving it a second alteration of form and a second chance for deformation. It is then driven through the bore and out the muzzle. With black powder and lead bullet rifles it will be seen that it makes little difference if the groove diameter of the bore is slightly larger than that of the bullet, as the upset of the latter will take care of this. Also it will be noticed that the bullet expands at once and forms a gas dam, and no gas can escape ahead of the bullet.

Now let us see what takes place with smokeless powder and a jacketed bullet. Here the action is entirely different, owing to the different components. When the cartridge is fired in the chamber the shell instantly expands to the full size of the chamber, the bullet on account of its tough jacket resisting expansion for the instant. This permits

the gas to rush forward around the sides of the bullet, and between the bullet and the shell, absolutely preventing the expansion or up-settage of the bullet at this point. Some of this gas which rushes up between the bullet and shell escapes ahead of the bullet and precedes it out the muzzle. This gas rushing past the bullet actually decreases the diameter of the bullet by gas cutting (but probably an inappreciable amount) and it also enlarges or gas cuts the bore slightly for that distance ahead of the chamber during which it continues to rush past the bullet. This gas cutting of the bore for one shot is inappreciable, but will probably be large enough to be seen with the eye after it has occurred 500 times. The bullet starts forward surrounded with gas, and with a steadily increasing gas pressure in its rear. This pressure forces it up into the rifling. At its start into the rifling it has to be forced by the throat of the chamber into line with the axis of the bore, for remember it did not lie in this line before the rifle was fired. The bullet starts to wobble up the bore. If the bullet at the start is as large as groove diameter, the gas escape past it is quickly cut off. If, however, it is smaller than groove diameter, it literally "wabbles" up the bore, surrounded by gas rushing past it and gas cutting both bullet and bore, until such a time as the resistance offered by the lands of the rifling, the bullet metal displaced by the lands, and the inertia of the bullet itself have caused the bullet to become expanded to a gas-tight fit in the bore by the gas pressure in rear. The reader can imagine for himself what occurs to the perfect bullet which he started with. It certainly is not made more perfect during such contortions.

Of late years, due to development in the science of photography, we have been able to photograph the phenomena occurring at the muzzle of the rifle at the instant of firing. A series of such photographs show issuing from the muzzle of the rifle, first, a column of air; second, a considerable amount of powder gas; third, a decrease in the amount of gas followed immediately by the bullet; and fourth, the main column of gas behind the bullet. This shows conclusively that gas escapes ahead of the bullet.

GAS CUTTING OR EROSION

If we examine the bore of a rifle having a commercial chamber, and using high-pressure powder and jacketed bullets, selecting one for this purpose that has been fired from 500 to 1000 rounds, we will notice an apparent wearing away and rounding off of the lands of the rifling at the breech and for quite a little distance up the bore from the breech.

Not only is the rifling apparently worn, but the whole surface of the bore appears to be roughened and cut up. If our rifle is one in which the groove diameter is the same as the diameter of the bullet, this gas cutting or erosion is not perhaps very bad, and extends but a little way up the bore, because the bullet has quickly sealed the bore and cut off the rushing gas which does this cutting. But if the barrel is larger than the bullet, then we find considerable gas cutting, and we also find it extending much farther up the bore than in the first case, perhaps six or seven inches, as the loose bullet wobbled a considerable distance up the bore before it finally expanded to form a gas dam.

This erosion or gas cutting will continue in the case of all high-power rifles with commercial chamber until it ruins the accuracy of the rifle; that is, until there is no more rifling left at the breech, and the bullet has to jump forward quite a distance from the chamber before it encounters the rifling. This wearing out through erosion is of course gradual, and the barrel may become too inaccurate to satisfy the marksman in from 500 to 8000 rounds, depending upon many things; the principal factors being the fit of the bullet, the size of the powder charge, and the heat developed by the gas of the particular powder which is used. A high-power rifle always wears out through this erosion or gas cutting, and never from the friction of the jacketed bullets, as popularly supposed. After a barrel has been completely worn out in this manner, an examination of the rifling at the muzzle and for a considerable distance down the bore from the muzzle will show that there has been no wear here, the bore being practically perfect. We are of course supposing that the rifle is properly cleaned and cared for during use. As a matter of fact almost invariably a barrel becomes inaccurate not through wear, but from rust and the accumulation of fouling due to lack of proper cleaning and care.

DEGREE OF ACCURACY

In order that one may have a proper conception as to how the accuracy is affected by all these occurrences in the bore, it will be best here to give a short summary of accuracy tests with barrels having chambers of various degrees of tightness and with bores both the size of the bullet and larger than the bullet. Let us take the .30-caliber, United States magazine rifle, Model 1903 (New Springfield), for example. This rifle has a standard groove diameter of .308 inch, and the bullets measure from .308 to .30825. The chamber is cut with an allowance of about .003 inch at the neck to take care of large cartridges,

dirt, etc. Very careful and prolonged tests with this rifle and good ammunition show conclusively that it will average 2.50-inch groups at 100 yards and 5-inch groups at 200 yards. Occasionally it will give better groups than this, but this is the average. If we were to eliminate the off-shots in each group, which aggregate about 20 per cent. of the whole number of shots, we would get groups of about 1.50 inches at 100 yards and 3 inches at 200 yards. Now we will take a rifle very similar to this but having a slightly closer chamber, namely rifles with special target barrels for the .30-40 and .30 Model 1906 cartridge, made to order by the Winchester Repeating Arms Company. These barrels

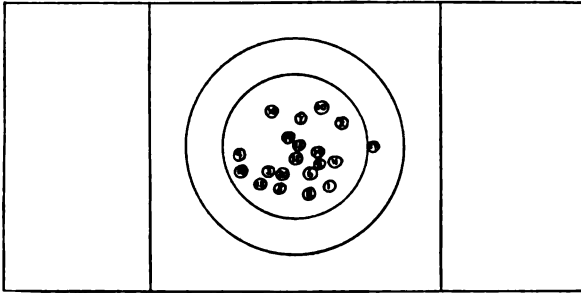

Fig. 92

Twenty consecutive shots fired at 1,000 yards by the author with U. S. rifle, Model of 1903, winning the Adjutant General's match. Rem.-U. M. C. ammunition, 172 grain bullet.

are cut with a slightly tighter chamber than that of the government arm, having a clearance at the neck of only about .002 inch, and the groove diameter is .308 inch for bullets measuring .308 to .30825 inch. Careful accuracy tests with a number of these barrels show that they will shoot a little closer than the government barrel for the same cartridge, giving groups of about 2 inches at 100 yards and 4.25 inches at 200 yards. These are the very best barrels made at the present writing by any of the large arms companies. They are made to special order only at an extra cost, and are usually fitted to Model 1898 and Model 1903 government actions.

Next, let us look at the various commercial sporting rifles designed for hunting or sporting ammunition, selecting those cartridges which, from their design, we would expect to be accurate. Such rifles usually have a groove diameter from .001 to .002 inch smaller than the bullets, and the chamber has an allowance of about .003 inch at the neck. Such rifles, if used with good ammunition, will give groups

running from 3.00 to 4.00 inches at 100 yards, and from 6.50 to 9.00 inches at 200 yards. I have made accuracy tests of a certain make of a very high velocity rifle of American make which has been extensively advertised as giving extremely flat trajectory and fine accuracy. The chamber has an allowance of almost .0045 inch at the neck and the bullets are .002 inch smaller than groove diameter. A number of these barrels tested at 200 yards showed groups running from 8.50 inches to 14 inches, the average being 12.45 inches. There was no semblance of accuracy, nor could a normal group be picked out from 80 per cent. of the shots. All the shots seemed to be off-shots; that is, all of the bullets had been badly deformed in the barrel.

VERY TIGHT CHAMBERS

It would seem from the foregoing that the remedy for the above off-shots would be, in addition to seeing that the bore was perfect and the same diameter as the bullets, to chamber the barrel as tightly as possible. This undoubtedly will help a lot. It is possible to chamber with a clearance of only .001 inch and still have enough clearance to take care of good factory ammunition and hand-loaded ammunition in factory shells, provided the arm is used by a careful and intelligent rifleman who keeps chamber and ammunition clean as they should be. I have a .25-35 Winchester single-shot rifle chambered in this way to special order, and it is an excellent shooting little arm. It gives groups at 100 yards averaging 1.75 inches. This is about the best that can be obtained from rifles using the ordinary factory shell. The trouble which we encounter here is that the factory shell is drawn and not accurately turned. Hence it is not truly round, nor of uniform thickness throughout its entire diameter. There must be an allowance in the chamber to handle such shells, and it can also be clearly seen that no matter how true the chamber the bullet can never lie accurately in line with the axis of the bore before firing if it is seated in such a shell.

THE MANN-NEIDNER CHAMBER

The remedy for all this trouble has been most carefully worked out by Dr. F. W. Mann assisted by Mr. A. O. Neidner, the expert rifle mechanic, and is a result of years of most careful experiment on Dr. Mann's private experimental rifle range. Dr. Mann took the ordinary commercial shell and proceeded to ream it out at the neck so that it should have a perfect cylindrical shape and be a perfect fit for the bullet. Then he placed this shell in a lathe and turned it down until

it was perfectly round at its neck and had a uniform diameter of metal at the neck. The rifle was then most accurately chambered for this shell, so as just to take the shell without any allowance other than that necessary for insertion and extraction. The chamber is most accurately cut so that the neck shall be in exact line with the axis of the bore, and when the cartridge is inserted and the breech closed the bullet lies exactly in line with the axis of the bore. When such a cartridge is fired in such a chamber the shell does not expand; it cannot, on account of the tight chamber. Neither does the bullet upset. The bullet simply moves straight forward in line with the axis of the bore, and enters the rifling perfectly true and with the minimum of deformity, hence, practically, we only find those errors at the target which are caused by defects in the manufacture of the bullet. In such a barrel there is no escape of gas past the bullet because the bullet forms a perfect gas-dam all the time. There is consequently no erosion or gas cutting, and such a rifle has an almost unlimited accuracy life. Such barrels with specially selected bullets will give groups averaging about 1.25 inches at 100 yards and 2.60 inches at 200 yards. They are the equal of the Pope muzzle-loading rifle as regards accuracy, with the added advantage of very high velocity. They obtain this velocity with very much less powder than the ordinary rifle takes. It is hardly believed, however, that a rifle chambered in this way is suitable for military work or for rough hunting use. The cartridges insert a little stiffly. If the chamber be dirty they are quite difficult to insert and they are liable to stick in a dirty chamber. Any slight injury to the shell makes it impossible to insert the cartridge in the chamber. Hand-loaded ammunition with specially reamed and turned shells must of course be used. Such rifles are at their best as target arms, and as squirrel and woodchuck rifles. That is, for use under circumstances which call for the very best accuracy and which will allow of perfect care being taken of the equipment. For rougher work I do not believe it is possible to surpass the special match barrels mentioned above, which have a clearance of about .002 inch in the neck of the chamber, the groove diameter of the bore being the same as the diameter of the bullet. I have used such rifles for years in hard wilderness hunting with perfect satisfaction.

INFLUENCE OF THE POWDER CHARGE ON ACCURACY

A poor powder, or a wrong selection of good powder for a particular rifle and charge, may of itself entirely ruin the accuracy. There

must be uniformity of burning to give even velocity from shot to shot, or the ammunition will be very uneven in its elevations. Uniformity of burning depends somewhat on composition of the powder, but more on evenness of granulation and character of the grains. Nearly all modern powders are excellent in this respect. Uniformity, however, is secured only within the range of normal working pressure for each powder. For example, a certain powder may burn uniformly only when a pressure of from 38,000 to 42,000 pounds per square inch is attained. When the normal working pressure is exceeded, or when less is developed, the burning becomes erratic and unreliable.

There must be complete burning of the powder charge, preferably just completed in the length of barrel used. Incomplete burning means unburnt grains of powder which add to the fouling, and it is also usually accompanied by lack in uniformity of pressure and velocity. Neither should the powder burn too quickly, as this gives high pressures, and tends to bullet deformity. Black powder left a heavy residue in the bore after firing, and with this powder it was impossible to fire many rounds before this residue destroyed the accuracy. In dry weather, particularly, black powder would cake in a solid, hard mass in front of the chamber after from five to ten rounds, and destroy all accuracy. It was the custom with black powder to breathe through the bore between shots to keep the fouling moist and thus avoid this caking, and many riflemen even used special breathing tubes for this purpose. Black powder did its best work on moist and damp days, and towards evening when the air contained the most moisture. In long-range matches the riflemen often cleaned between every shot, pushing through the bore first a Fisher bristle brush wet with water, and following with a dry flannel patch.

The fouling of smokeless powder should be as little as possible, and should contain no hard lumps that may get into the chamber and prevent the cartridge seating uniformly, or into the action and prevent the proper functioning of the rifle. It is incomplete burning which causes such solid residue with modern powders, and here we have the main reason for using only a powder which will burn completely.

The residue of modern powders should be non-corrosive, and easily removed as a further element of protection of the bore. In this respect the new progressive powders are apparently superior to both the regular burning nitrocellulose and the nitroglycerine powders. Nearly all modern powders are graphited, with the result that the residue they leave in the barrel has a lubricating effect of some value.

The matter of the selection of the proper powder to attain accuracy and the desired ballistic results is fully discussed in Chapter XII.

THE CARTRIDGE CONSIDERED

When dealing with the subject of accuracy we must consider the subject of the cartridge most carefully. Accuracy at distances much over 100 yards cannot be attained with a short, blunt bullet. To fly well to a considerable distance the bullet must either be long and heavy, or it must have a "spitzer" point. A spitzer point will allow a slight shortening of the bullet and still permit it to maintain its accuracy to long range. As a rule, accuracy at ranges over 150 yards cannot be relied upon with bullets of less weight than the following:

Caliber	Blunt point	Spitzer point
.25	86 grains.	80 grains.
.28	120 grains.	100 grains.
.30	160 grains.	140 grains.
.32	165 grains.	150 grains.
.35	200 grains.	170 grains.
.38	250 grains.	220 grains.
.40	300 grains.	280 grains.
.45	350 grains.	...
.50	450 grains.	...

Bullets intended for use over 500 yards should be at least 10 per cent. heavier than the above. The higher the velocity, the longer the bullet should be, or the sharper the point in order to maintain accuracy. Short, blunt bullets cannot be speeded up very much without ruining the accuracy. Thus the .32-20 high-velocity cartridge is very much less accurate than the same cartridge with the regular velocity of 1325 feet per second.

Keeping the above in consideration and examining the size of the chamber and the fit of the bullet to the bore, it is possible to estimate in advance just about what accuracy can be obtained from any cartridge and rifle, and my own accuracy tests have shown that a calculation based on the principles laid down in this chapter will agree with remarkable closeness with the results obtained from an actual test.

DESIGN OF RIFLE

The design of the rifle has a certain important bearing on the accuracy. Formerly it was the opinion that a very long barrel contributed to accuracy. Such is not the case. There is very little difference between the accuracy of a 20-inch barrel and one of 30 inches in length, and there is practically no advantage in having a barrel over 24 inches

in length, except that with the longer barrel we always get a slightly increased velocity and a slightly longer and more accurate sight radius. A heavy barrel is always more accurate than a thin barrel, and particularly a barrel having no slots cut in it for sights or forearm fastening should be chosen. No real accuracy can be expected from a take-down rifle. The grip of the rifle should be heavy and rigid, and the action very tightly screwed to the stock. These features and their influence on accuracy are considered in detail in the chapter on Zero Elevation, Barrel Flip, and Resting the Rifle.

CHAPTER XVIII

ACCURACY LIFE AND MOBILUBRICANT

WE are often asked: "How long will a rifle remain accurate?" "How many shots can be fired before a rifle loses its accuracy?" A rifle using black powder and lead bullets has a practically unlimited accuracy life. I have seen a Pope rifle which had been fired not less than 60,000 rounds, and then was still capable of giving 2½-inch groups of ten shots at 200 yards. The accuracy life of a high-power rifle depends upon the chambering, the bullet fit, the heat generated by the powder gas, the amount of powder in the charge, and the character of the jacket of the bullet, taking for granted, of course, that the bore is properly cared for. Very few rifles are worn out through use alone. By far the great majority of them become inaccurate from lack of care, or lack of proper care.

A smokeless-powder, high-velocity rifle, when always properly cared for, becomes inaccurate through the erosion or gas cutting of the bore in front of the chamber. As we have seen in the chapter on Accuracy, this is caused by the escape of gas past the bullet in commercial chambers, and also where the bullet is slightly smaller than the bore. The gas rushes past the bullet when the latter is starting from the shell, and also in the case of small bullets, when it is passing the first few inches up the bore. This gas is intensely hot, and being fired through a very small opening, and thus brought into close contact with the steel, it cuts like a sharp tool, very little indeed at a time. After from five to fifteen hundred rounds have been fired from a high-power rifle with fairly loose commercial chamber, a careful examination of the bore from the breech will reveal a slight dulling of the lands just in front of the chamber, and for perhaps an inch or two up the bore. As the firing progresses this wear will become more pronounced, and the bore just in front of the chamber will become gradually rough and apparently pitted. The worn portion will extend gradually farther up the bore. It will extend much farther up the bore in a rifle using small bullets than in one which uses bullets which are full groove diameter. We find that in rifles having these commercial chambers the erosion or gas cutting appears sooner, and progresses faster in rifles which use a large

charge of powder, and in rifles using the old nitroglycerine powders with their hot gases, than in rifles which use the new pyro-cellulose powders which have much cooler gases; and that the tighter the chamber the less the gas cutting. We also find that high-power rifles cut with the tight, perfect Mann-Neidner chamber do not develop gas cutting, as it is impossible for gas to leak past the bullet, and that such rifles apparently do not wear out. I have in mind one of these rifles shooting a .25-caliber bullet at the extremely high velocity of 3300 feet per second, which has been fired 12,000 rounds and no erosion or falling off in accuracy can be noticed.

As this gas cutting progresses, the barrel gradually becomes enlarged at the breech until it reaches that point where the bullets begin to jump through space after leaving the shell and before they encounter the rifling. This of course causes a deformity of the bullet, and as the enlarged space grows the deformity grows, until it reaches that point where the inaccuracy is such that the marksman can notice it on the target. Usually the barrel is discarded at this point as worn out, but if the shooting were continued it would be only a question of time before the rifle would be entirely inaccurate from this cause.

I have no data as to the accuracy life of rifles of the .30-40 class when used with commercial ammunition and well taken care of. They will probably last with accuracy unimpaired for many thousand rounds as the charges are comparatively light. Rifles like the .32 Winchester special and .35 Remington auto-loading should last for a lifetime as the bullets are full groove diameter, the twist of rifling is comparatively slow, and the powder charges are light. Coming to the .30-40, we have more definite information on this subject, as this cartridge was from 1892 until about 1906 the standard government cartridge. The standard load for this cartridge after the Spanish-American War was 34 to 35 grains of Laflin and Rand W. A. powder. This was a nitroglycerine powder and had a relatively hot gas compared with the modern Du Pont pyro powders. The bullet was full groove diameter. The chamber was about .0035 inches larger than the outside diameter of the neck of the standard shell. It was found that this rifle could be fired from 1000 to 1500 rounds before any falling off in the accuracy could be noticed by an expert, long-range shot. There is one case of excellent accuracy at 1000 yards after 3000 rounds had been fired. When the rifle is perfectly taken care of, the accuracy at ranges up to 500 yards remains very good up to about 3500 rounds, certainly this number could be fired before it would become necessary to discard

this rifle for hunting purposes. Using the new Du Pont military rifle powder No. 20 (Pyro) I would expect the accuracy life to be at least 6000 rounds, shooting with dry bullets as will be explained later.

Coming now to a much more powerful rifle, and one using only nitro-cellulose powder, the .30-caliber Model 1906 cartridge, we find that where the rifle is used for slow fire only, that is fired on the target range from 10 to 20 rounds at a time, and about a minute interval between shots, from 2000 to 3000 rounds can be fired before any falling off in accuracy would be apparent to a good long-range shot. Where, however, much rapid fire is indulged in, with its attendant heating of the barrel, the accuracy life will be much shorter than this. Rapidity of fire has much to do with speed of progression of the gas cutting. One could probably fire this rifle slow fire from 6000 to 7000 rounds before it became so inaccurate as to be unsuitable for game shooting.

The cause of inaccuracy has not been understood by riflemen until recently. Formerly it was thought that the friction of the jacketed bullets had much to do with it, but this is almost entirely negated by the fact that when a barrel becomes entirely inaccurate through gas cutting at the breech, an examination of the bore at the muzzle and for a considerable distance down the bore from the muzzle, will show that the rifling is still intact and perfect. If the jacketed bullets caused wear, it stands to reason that evidence of this wear would be seen throughout the entire bore. When riflemen believed this there was a great hunt for a suitable lubricant for the bore and bullet. It does seem to be a sort of a mechanical cruelty to shoot a jacketed bullet through a steel bore without lubricant. Under the high pressures now developed the friction would seem to be enormous. At first no suitable lubricants were found. The temperature developed by the gases in the barrel is so great that lubricant undergoes chemical disorganization — is split up into its constituent elements, carbon and hydrogen. The hydrogen, being a gas, escapes, leaving the carbon behind; and carbon, far from being a lubricant, only adds to the fouling of the rifle.

About 1906 we made the change to the Pyro powder which burns with a much cooler gas, and at the same time the growth of the automobile industry resulted in the placing on the market of a number of thick greases having a very high fire test; that is, they became chemically disorganized at a much higher temperature than the old lubricants. It was found that a certain one of these lubricants called Mobilubricant, manufactured by the Vacuum Oil Company of Buffalo, New York,

apparently worked satisfactorily as a barrel and bullet lubricant, and supplied the long-felt want. In practice all portions of the bullet which are exposed outside the shell are given a thin, even coating with this grease, the bullet inserted in the rifle greased in this manner, and then fired. The grease is a thick yellow grease of about the consistency of butter at a temperature of 70 degrees. It was found that when the rifle was fired with bullets thus greased, it required from one to two minutes less elevation at all ranges, in many cases it resulted in better accuracy, and the bore did not accumulate metal fouling nearly as fast as when the bullets were fired dry. This latter fact made cleaning much easier. After extended use for several years it was found that the use of this grease on the bullets apparently just about doubled the accuracy life of the barrel. The use of Mobilubricant has now become almost universal among well-uniformed target shots.

Mobilubricant does not, as is generally believed, act as a true lubricant in the bore. Instead, its use seems to result in coating the bore with a tenacious covering of somewhat the consistency of celluloid. This covering apparently gives a smooth surface to the passage of the bullets, thus preventing any great accumulation of metal fouling. When using this grease it is seldom that we see the small lumps of metal fouling adhering to the bore near the muzzle. Instead about all that is present is a very thin, even plating of cupro-nickel all over the bore, and this plating is easily removed by simply swabbing the bore with ammonia on the cleaning patch, thus greatly simplifying the cleaning of the rifle. Also, this celluloid coating seems to reduce the erosion, probably by preventing the gases from coming into as close contact with the bare steel of the bore. We have long known that grease will to a great extent prevent gas from touching metal. A wax wad over the powder will effectively prevent the base of a lead bullet being fused by the powder gas. It is a fact that the constant use of Mobilubricant on the bullets will just about double the accuracy life of the .30-caliber, Model 1903 rifle, and similar rifles. I have at present one of these rifles with which I have kept a very careful record. It is a most accurate piece. It has won two matches for me with scores of 99 and 98 in 20 shots at 1000 yards, as well as numerous other matches at shorter ranges. It has been fired to date 5240 rounds, and the last 12 shots fired at 600 yards resulted in 12 bull's-eyes. This rifle has never had a dry bullet fired through it. All have been greased with Mobilubricant. Also it has been most carefully cleaned at the end of every day's firing with the regular metal fouling ammonia solution. The

barrel is still in beautiful condition, and scarcely any gas cutting can be seen. I should say that the barrel will be good for several thousand rounds more before it becomes inaccurate.

All the arms companies and powder manufacturers advise against the use of Mobilubricant. This is because its use increases the back thrust on the breech bolt. Normally, when the rifle is fired, much of the back thrust on the head of the shell and face of the breech block or bolt is taken up by the friction of the sides of the shell against the sides of the chamber. When Mobilubricant is used the chamber and the sides of the shell become greased, and as a consequence the shell slides back easily under the pressure, and a much greater pressure is exerted against the face of the breech. This increase of pressure on the bolt head has been estimated to be about 15 per cent., and many people are afraid of it. Personally I believe that in all modern arms there is plenty of safety margin to take care of this. We find that, where there is any damage done to the breech mechanism through *slightly* excessive pressures, this damage invariably results from the shell giving away, particularly an enlargement of the primer pocket, or the primer being punctured or blown out entirely, thus allowing gas to escape to the rear. A slight increase in the back thrust on the breech bolt would result in a little hammering back, and the rifle might fail, after a time, to breech up as closely as when new, but it is extremely unlikely that any accident would occur. This failure to breech up tightly would be more liable to occur in lever action, and automatic rifles which are at present made of slightly softer steel than our bolt-action rifles, and I would therefore recommend that Mobilubricant be used only with bolt-action rifles, or with the Winchester single-shot rifle, as those have not only plenty of extra strength to stand excessive back thrust, but there is practically no chance of their gradually failing to breech up tightly. In this connection I want to call attention to what might be termed abuse of Mobilubricant. I have seen marksmen stick their cartridges in the grease so as to cause a large lump, or "gob," of it to adhere to the bullet, and also get the shell all greasy. No reliable results can be obtained in this way. In fact a largely varying amount of Mobilubricant from shot to shot will result in uneven elevation. Each bullet should be inserted into the grease almost up to the brass shell, and then rotated slightly so that it will acquire a very thin, almost invisible coating of the grease. Care should be taken that no lumps of grease adhere to the bullet, and that no grease gets on the shell. In this condition the cartridge is placed in the chamber or in the maga-

zine of the rifle. There is on the market a little instrument called the "Spitzer Greaser," intended for lubricating the bullets of the .30-caliber Model 1906 cartridge with Mobilubricant. It consists of a small round metal box with cover, somewhat like the round nickel boxes that shaving soap comes in. The box is filled with Mobilubricant, and on top of the grease is placed a steel washer which is just the size of the inside of the box. This washer has a hole drilled in the middle which is just the diameter of the bullet. To use it the box is opened, a cartridge taken in the hand, the end of the bullet inserted in the hole in the washer, and pressed downward. The cartridge is given a turn or twist and then withdrawn. Only the bullet will pass through the hole in the washer and can come into contact with the grease. When the cartridge is pressed down, the edge of the shell comes in contact with the rim of the hole in the washer and presses the washer down. This puts pressure on the grease, and presses the grease into contact with the bullet at all points. Thus the bullet gets a thin, even coating of grease, and the shell is kept perfectly clean. This Spitzer Greaser is a very handy little contrivance. Grease can be carried in it in the pocket and cartridges always easily and neatly greased before being placed in the magazine or chamber.

It seems to be best, before starting to fire the rifle, to pass through the bore a cleaning patch very slightly greased with Mobilubricant, so as to give the bore a very slight, but even, coating of Mobilubricant before the first shot. I would expect Mobilubricant to fail in the extreme cold of arctic regions on account of the grease freezing.

With some military rifle shots who shoot practically every day throughout the whole summer it has become the custom to use Mobilubricant and never clean the rifle during the entire season. At the end of a day's shooting a patch coated with Mobilubricant is pushed through the bore once and the rifle set aside. In the morning before shooting a clean, dry patch is pushed once through the bore before shooting. The bore receives no other attention whatever the entire season. Treated in this way a rifle shoots very uniformly, and excellent results are obtained *under these conditions*. It must be remembered, however, that the rifle is fired every day except Sundays, and as heat kills rust, the rust in the bore is killed each day. Also the rifleman sacrifices a barrel each season, for at the end of the season when the barrel is thoroughly cleaned after being fired in this way, it will be found to be completely ruined. This system will not work at all when the rifle is only fired occasionally, say once a week or once a month,

or at odd intervals as the hunter fires his rifle. Such lack of cleaning under these circumstances would soon result in a ruined rifle. I believe that the best practice is thoroughly to clean the rifle every evening after firing, with ammonia in the regular manner, and always to use Mobilubricant on every bullet, greasing the bullets uniformly with the Spitzer Greaser. I have had excellent results with this method.

Appended below I give a synopsis of the results of a test conducted by the United States Marine Corps with a view to determining the results of using Mobilubricant and not cleaning the rifle during the season's firing.

MARINE CORPS EXPERIMENTS WITH MOBILUBRICANT

Conducted by Capt. D. C. McDougal, Marine Corps.

Four rifles were used, two of them being shot dry, and two with grease. Rifles fired from machine rest at 600 yards, 30 shots on each target. On 2 machine rests a dry gun and a greased gun were sighted in, and when ready both were fired as rapidly as possible until the 30 shots had been fired from each. The rifles were then taken out of the machine rests, the targets changed, old targets measured, and the next pair of rifles similarly shot. The dry rifles were cleaned with ammonia carefully after each test, but the greased rifles were left absolutely uncleaned throughout the tests.

For the first 400 rounds the dry rifles gave groups much better than the greased rifles, and had the tests been concluded at this point the conclusion would have been reached that the greased rifles did not compare favorably with the dry rifles that were cleaned after every 35 rounds, about.

However, at a point somewhere after 400 rounds the greased rifle groups which had been improving all the time, began to be smaller than the groups given by the dry rifles, and from this point on, in nearly every instance, the greased rifles gave better groups than the dry rifles, the dry rifles showing a tendency to make larger groups as the test continued. The rifles were calibrated after 500 rounds had been fired, the two dry rifles showing a tendency to bell at the muzzle. The greased rifles showed a smaller calibration than when the test commenced, both calibrating nearly .304 inch, showing that the grease and residue had formed a hard, smooth, somewhat elastic lining, which was evenly distributed over the surface of the bore. Neither of these rifles had been cleaned in any manner, and while they showed a slight rusting after a damp night, the groups would be just as uniform at the beginning of a day's firing as at the end.

After a thousand rounds had been fired the dry rifles were found to be very badly belled, and a little gas cutting could be seen at the breech end. There was a tight spot about ten inches from the muzzle in each. The greased rifles had decreased in bore to .303 inch, but a second calibrating bullet being pushed through showed a slight increase to .304 inch.

The test was continued from there on until 3300 rounds had been fired, when the dry rifles were found to be making such large groups that the test for these two rifles was discontinued. The groups were so large and scattered that it was difficult to prevent losing one or two shots off the target unless the rifles were carefully sighted in to get the center of the shot group exactly in the center of the target.

The greased guns at this stage showed up as well, if not better, than at any point in the test, and it was decided then to carry on the test until the rifles using grease showed targets of the same size and patterns as the dry rifles had in 3300 rounds.

One rifle was cleaned, and a few groups were made with it cleaned, "doping" with ammonia after each group to see the effect that cleaning would have on a rifle after firing this number of rounds with grease. The groups given by this rifle were considerably larger than those which it gave before cleaning, so much so as to show conclusively that its value as to accuracy had been ruined by the cleaning. Two hundred rounds were then fired out of this rifle with grease as rapidly as possible, no measurements being taken, and then a series of targets were made to see if the rifle had regained any of its accuracy. These groups showed that the Mobilubricant did bring the rifle back and increase its accuracy, but it was never quite as good as it had been before it was cleaned.

Firing was continued with the rifle using grease that had not been cleaned and the groups were constant and uniform until 7000 rounds had been fired. The groups then commenced to show an increase in size, which continued until after 7700 rounds had been fired, when the groups became of about the same size and pattern as the dry rifles had shown after 3300 rounds had been fired from them. The test was here concluded.

Please notice that in this test each rifle was fired thirty rounds at each target, these thirty rounds being fired *as rapidly as possible*. The barrels thus became very hot indeed, much hotter than they ever do in ordinary use.

CHAPTER XIX

ZERO ELEVATION, BARREL FLIP, AND RESTING THE RIFLE

BECAUSE a certain load in a certain rifle strikes higher on the target than some other load in the same rifle, the range and sight adjustment being the same, is no reason for the positive assertion that the former load is more powerful or has a flatter trajectory than the latter. In order to compare correctly elevations, trajectories, and points of impact, it is necessary to have a zero elevation for each load to work from. This zero is the base from which we must measure in each case. It would seem at first glance that the prolongation of the axis of the bore would give such a zero, but this is not the case. A bullet does not leave the bore in prolongation of the axis of the bore as that bore appears, or is located while at rest, but as the bore is located when the bullet leaves the muzzle. The point of impact on the target alone is no indication of either the velocity or the trajectory.

When the rifle is fired the disturbing influence is the recoil. The action of the recoil is straight back in line with the barrel, but the resistance is always below the line of the barrel; that is, the center of gravity of the rifle and the resistance of the shoulder applied to the butt plate. When the recoil comes, this low resistance causes the whole gun to try to revolve around the center of resistance. This sudden pressure bends the rifle into a curve, with the center below the barrel, and causes the muzzle to dip, and the breech to rise out of the line of the axis of the bore as that axis was before the ignition of the powder took place. The high-power rifle with light barrel, therefore, shoots lower at all ranges than a line in prolongation of the axis of the bore.

Bore sighting experiments:

With a Winchester single shot rifle, caliber .30-40 United States (Krag) with 27-inch heavy No. 3 barrel. The telescope sight mounted on top of the barrel was correctly adjusted for 100 yards for the regular .30-40-220 soft-point, Winchester, high-power ammunition. The rifle was then clamped in a heavy vise and the telescope sighted on a target 100 yards away. A sight was also taken at the target through the bore, and it was seen that the sight on the target through the bore

struck the target 5 inches above the point on which the cross-hairs of the telescope were aligned.

With another Winchester single-shot rifle, also with No. 3 barrel, using a .25-35 W. C. F. shell and a charge consisting of 22 grains of Du Pont military rifle powder No. 20, and an 86-grain, soft-point jacketed bullet, the difference between the bore sighting and the correct elevation on the telescope sight, at 100 yards, was 6½ inches.

With a United States Model 1903, sporting rifle, using the 1911 Winchester National Match ammunition, the rifle being equipped with the Lyman No. 48 rear sight, the difference was apparently only about an inch. (We should, however, expect, and usually would get, a greater difference with a thin barrel like this than with the stiff heavy barrels used in the first two experiments.)

If the barrel be rested on any substance near the muzzle, the downward dip of the muzzle will be restricted, and the rifle will shoot higher than it did, say, when fired off hand. The harder this rest, and the nearer it is to the muzzle, the higher will the rifle shoot, but it will practically always shoot (that is, the bullet will depart from the muzzle) on a line or tangent below the prolongation of the axis of the bore at rest. When a military gunsling is used in the prone position the rifle rests in the hand, and the sling pulls down very hard on the barrel a few inches in front of the hand. This helps to increase the bend of the rifle in a curve with the center below the barrel, and causes the shot from the rifle held in the prone position with sling to hit lower on the target than when the rifle is fired off hand or rested. We will call the off-hand elevation the normal elevation for a sporting arm. Such an arm will then require a higher elevation for shooting in the prone position with gunsling, and a lower elevation when shooting with a muzzle rest. This will be shown in the following experiments:

EXPERIMENTS IN RESTING A RIFLE

Two rifles were used. Both were of .30-40 United States (Krag) caliber, and the ammunition used was the soft-point, factory ammunition with the 220-grain bullet manufactured by the Winchester Repeating Army Company and purchased in January, 1914. The bullets were greased with Mobilubricant, fouling shots were fired before starting the tests, and the rifles were not cleaned throughout. The range was 100 yards.

The first rifle, which I will hereafter refer to as the "heavy barrel,"

was a Winchester single-shot rifle with a 27-inch No. 3, round barrel; and was sighted with a Winchester A5 telescope sight. The second rifle, referred to as the "light barrel," was a United States Model 1898 (Krag), with a 26-inch Winchester barrel of the same shape and weight as the regular barrel furnished on the Winchester Model 1895 rifle, except that it did not have any sight slots, or firearm stud slots cut in it. The sights on the second rifle were a gold bead front sight blackened with camphor smoke, and a Lyman No. 48 rear sight. The two rifles used the same ammunition, and were practically identical except as to weight of barrel, and length and drop of stock. The light barrel rifle had a stock, the drop at the heel, and the length of which, were both 1 inch more than in the case of the heavy barrel rifle.

The muzzle rest in the case of both rifles was a poplar board, 1 inch thick. With the "hard" rest the barrel of the rifle was rested directly on this board. With the "padded" rest the board was covered with an Army blanket, folded to eight thicknesses, and the barrel rested thereon. In firing the rifle from the prone position, the regular military prone position with gunsling was used, and in this position it should be understood that a heavy pull (about 50 pounds) is exerted on the front sling swivel.

Each rifle was first fired from a table rest, sitting position, with the forearm resting on the padded rest at a point 6 inches in front of the breech of the barrel. Many previous experiments have shown that the elevations obtained in resting in this manner agree exactly with the offhand elevations. Care must be taken to sit fairly upright when shooting, and to receive the recoil on the shoulder in the same manner as when shooting offhand. In the data which follows the point of impact as found with this padded forearm rest is the point on the target from which measurements were taken in giving the location of the other groups obtained under varying conditions of rests. In other words the data shows how far off, and in what direction the rifles shot from the offhand point of impact when rested in various ways.

TESTS WITH HEAVY BARREL

Ten shots, padded forearm rest, gave a group measuring 2.4 inches.

Five shots with padded rest, 4 inches from the muzzle, gave a 1.5-inch group which was 1.25 inches above, and .30 inch to the right of the point of impact with the padded forearm rest.

Five shots with hard rest, 4 inches from the muzzle, gave a 2.3-inch group, which was 2.25 inches high and in perfect line.

Five shots prone with gunsling, gave a 2.23-inch group, which was 1.50 inches low and .90 inch to the right.

TESTS WITH LIGHT BARREL

Five shots with padded forearm rest gave a 2.88-inch group.

Five shots with padded rest, 4 inches from the muzzle, gave a 3.50-inch group, which was 1.25 inches above and 1.70 inches to the right of the point of impact with the padded forearm rest.

Five shots with hard rest, 4 inches from the muzzle, gave a 3.50-inch group, which was .60-inch high and 1.80 inches to the right.

Five shots prone with gunsling gave a 2.95-inch group which was .2 inch low and .9 inch to the right.

TESTS WITH REDUCED LOADS

A test with reduced loads at 25 yards was then undertaken with the light barrel. The load was as follows: Peters 115-grain, .30-30 short-range, soft-point, jacketed bullet; 12 grains Du Pont gallery rifle powder No. 75; Frankford shells; Remington-U-M-C No. 9 primers. This is a very accurate load up to 100 yards in Winchester barrels. At 25 yards with this light barrel this load shot 3 inches lower than the full charged ammunition used in the previous tests, the sighting being the same in each case. As before, the basis was the point of impact found with the padded forearm rest.

Five shots with padded forearm rest gave a group measuring 1.12 inches.

Five shots with hard muzzle rest, 4 inches from the muzzle, gave a group measuring .9 inch, which was 1.12 inches above and .62 inch to the right of the group fired with the padded forearm rest.

Five shots prone with gunsling gave a group measuring .50 inch which was .8 inch to the right of the group fired with the padded forearm rest.

In the above experiments the question kept constantly in view was: "If a sportsman has a rifle correctly sighted for offhand shooting, how will it be affected by resting the barrel in various ways such as might occur in sport and service?" These tests show the actual effect of so resting the rifles having both heavy and thin barrels. I am inclined to think that the horizontal deviations with the light barrel were due to some cause connected with the unequal support given to the breech block of the Krag rifle by the one locking lug on the bolt.

In shooting from the right shoulder the recoil of the rifle is up and to the right; if from the left shoulder, up and to the left; that is, the rifle pushes the man back on the side that he shoots from, and turns the rifle in the same direction. Now, if the right-handed man rests his rifle lightly against the right side of a tree, and holds his gun in the same place and position that he uses in offhand shooting, the recoil will turn the rifle away from the tree and the shooting will be normal; if he rests it against the left side the recoil will throw the rifle against the tree, and the shot will be wild. The converse of this holds for a left-handed shooter, or for a rifle with a left-hand twist of rifling.

The bending of the barrel, the dipping of the muzzle, and the lifting of the breech during recoil is usually called "flip." The flip is constant only for a given charge and the same barrel. A change of load will change the flip. Witness the different points of impact given with different loads, and as a consequence, the different sight setting required. It is well known to military shots that different makes of ammunition, often even different dates of loading of the same ammunition, will require different elevations, and this notwithstanding that the chronograph may show identical velocities. Notice that the Krag rifle used in one of the above experiments required 3 inches (12 minutes) more elevation at 25 yards for a light small game load than it did for the full charged load. Usually the lighter the load the higher the elevation required, but this is not invariable. I have a .40-72 Winchester Model 1895 rifle which shoots a reduced load 1 foot higher at 50 yards than it does the full charged load. The thin barrels of military rifles are very sensitive to flip, and often a warped forearm, or a tight upper band interfering with expansion of the barrel as it heats up, will cause a decided change in the elevation required.

With take-down rifles the flip is greatly increased by the joint between the barrel and receiver, so that it is almost impossible to get constant results from take-down rifles. Clamp the barrel of a take-down rifle in a very heavy, strong, solid vise; take a hold of the stock and push it down or up. Usually one will have no difficulty in moving the butt-plate up and down a half inch or more. Some of this movement is in the take-down joint, and some of it in the joint between the stock and action. These movements in joint between stock and action, and in take-down joint, are a serious detriment to fine shooting, as various conditions of tightness greatly affect the elevations and zero in shooting. A take-down rifle may shoot a fine small group on a

certain day, at a certain range, and with a certain sight setting, if one is careful to hold the rifle exactly the same for each shot. An expert shot can often get as fine a group from a take-down rifle as from any rifle, and the manufacturer will tell the prospective purchaser that the take-down does not interfere with the accuracy. But try this rifle some other day, and you will find that while it may still shoot a small group, its point of impact has changed entirely. The rifle which several days ago with a certain sight setting and range delivered its shots into the center of the bull's-eye may perhaps shoot way off today. I have gotten two small groups as much as 5 inches apart at 50 yards that I could account for in no other way. To shoot finely, a barrel must be screwed very tightly into the action, and it will help a little, perhaps, to solder it in. Also the stock must be screwed up very tightly to the receiver.

In order to compare correctly the trajectory of two or more loads by means of their point of impact on the target, or the same load under varying barrel conditions, we must know the zero elevation of each load, and must use this zero as a base to work from. Such data are easily obtained. Suppose the sights are $1\frac{1}{2}$ inches above the axis of the bore. The bullet of course begins to fall the instant it leaves the barrel. Let us say, for example, that a .30-caliber, 220-grain bullet, with an initial velocity of 2000 feet per second, in passing over a $12\frac{1}{2}$ -yard range falls $\frac{1}{8}$ inch. We can then sight the rifle in on a $12\frac{1}{2}$ -yard range so that the bullet will hit with its center $1\frac{7}{8}$ inches below the exact point aimed at ($1\frac{1}{2}$ inches, height of sight; plus $\frac{1}{8}$ inch, drop of bullet). This reading of the sight will then give us our zero elevation for that load. Suppose we fire this load at 200 yards and find that for this distance it requires an elevation of 8 minutes above the zero. Another load similarly requires an elevation of 10 minutes above its particular zero at the same range. This proves that the trajectory of the first load is flatter than that of the second. With the same sight setting it is possible that the second load may have had a higher point of impact on the target than the first load, and hence altogether mislead one as to its trajectory and power.

It is from experiments such as are detailed in this chapter that one thoroughly learns his rifle. It is not only necessary that a rifle have an accurate barrel, and shoot an accurate, well-loaded cartridge; it must also have a solid frame, a heavy grip, a tightly screwed-up stock, and sights capable of accurate adjustment and reading to minutes of angle.

None of these features detract from a hunting arm in the slightest. In fact they add to it greatly by permitting one to acquire that knowledge of his rifle, and skill in its use, which will make sure kills with the first shot possible, even at quite long ranges.

CHAPTER XX

THE POPE MUZZLE LOADING SYSTEM

THERE is a class of riflemen who indulge in shooting offhand at 200 yards at a bull's-eye target, either the German ring target or the Standard American target. This form of shooting was introduced into this country by the Germans, and is termed Schuetzen shooting. Some Schuetzen riflemen develop extraordinary skill in this sport, and of course extremely accurate rifles are in demand. There is no restriction as to the rifle except that it must be fired offhand without artificial support. The Schuetzen rifle is a type by itself. It is usually a very heavy rifle, sometimes as much as 13 pounds. It has a long, heavy barrel, and a comparatively light charge, the .32-40 and .38-55 cartridges being those usually used. The bullet is usually either loaded ahead of the shell into the rifling by means of a bullet seater so that it is already seated in the rifling centrally before being fired, and the shell full of powder loaded separately after the bullet; or else the bullet is loaded from the muzzle by means of a false muzzle and bullet starter, and shoved down by means of a ramrod to a point just in front of the chamber, the shell full of powder only being then loaded from the breech in the usual manner.

Among the makers of fine Schuetzen rifles one man stands supreme. Mr. Harry M. Pope has long held the reputation of being the most skilled maker of rifle barrels in the world. Of late years he has been making all kinds of rifle barrels, and his product has never been approached by any other maker. The barrels are made by hand entirely, and Mr. Pope will often spend a week on the cutting of one barrel. But it is in his Schuetzen barrels that his work is seen at its best. The Pope muzzle loading Schuetzen system as made by Mr. Pope himself is the very best in the world for accuracy up to 600 yards, bar none, and it might also be said that his high-power, long-range target barrels have never been surpassed for long-range shooting, although they are seldom seen because almost all long-range shooting is confined to military shooting and military competitions where the straight government-made, military rifle is prescribed. Mr. Pope will guarantee his Schuetzen barrels, muzzle loading, to shoot all their shots into a 2½-

inch group or closer at 200 yards, and I have yet to hear of one of them which has not made good. It is thought that Mr. Pope's own description of his system and methods will be of interest to the reader in view of the extraordinary results obtained with it, and also because this description is out of print and can no longer be obtained anywhere. It is therefore to a certain extent historical, and is appended here both on account of its interest, and so that it will not be lost entirely.

POPE RIFLE BARRELS

By H. M. POPE

By profession I am a mechanical engineer and a skillful workman; for recreation and by preference, a "rifle crank." I first made a barrel (entirely on a foot lathe) because I could not buy what I wanted; i. e., a .25 caliber, which I made in 1887, before this size was manufactured. My first charge was a straight shell holding 25 grains of powder and a 100-grain bullet, then a shorter one with 20 or 21 grains of powder and 85-grain bullet. Finding the making of a sufficient number of these shells on a foot lathe an arduous task, I re-chambered and swaged down a .32-20 shell. I used this shell for some time, but on making my first muzzle loader, I swaged down a .38 extra-long, center-fire shell, holding 30 grains, and using bullets up to 120 grains. With this rifle I did my best shooting under National Rifle Association rules. Being troubled with bursting shells, I finally swaged down .32-40 everlasting shells, using 35 grains. This did good work muzzle loading, but had passed the limit for accuracy for breech-loading with black powder. Shortly after this I accidentally injured my barrel and abandoned this rifle for a 13-pound rifle with set triggers, the state of my pocketbook at prize matches giving an unanswerable argument that this gave better results than the lighter arm, and later experience fully bears this out, and I find that I can still shoot a "practical" rifle with the rest, some "arms over your head" cranks to the contrary. (Proof, five dead deer with five cartridges, standing and running, all in thick woods at usual distances.) The conditions of target shooting and field shooting bear no resemblance to one another, the most difficult change being not the change in arm, but the change from a deliberate aim at a target to the snap shot at game. Therefore when you shoot at a target use every refinement known to increase your scores, as almost every refinement known for target use is impracticable in the field or woods.

During the period above mentioned I became interested in, and thoroughly convinced that, the so-called Schalke system, devised by

Wm. Hayes and Geo. Schalke, possessed advantages for offhand shooting that placed it far in advance of any other system of loading. This system I adopted, improving on Mr. Schalke's method of manufacture, and altering somewhat the form of cut, though retaining the essential features. The above mentioned heavy rifle, as well as the last .25 caliber, were so made. Their performance was so good that I had to

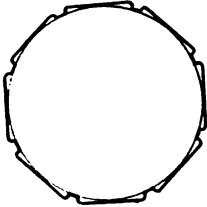

Fig. 93

The Pope muzzle
loading system
of rifling

fit out my intimate shooting friends, and their improvement in shooting was so marked that I began to be besieged by outside parties to make barrels for them. This, for a long time, I refused to do, but finally these inquiries became so numerous, and Mr. Schalke's death occurring about this time, I consented, with the result that my barrels are now in the hands of the most expert offhand shots in the country, and are making scores that are unsurpassed, and every man who shoots a Pope improves his scores. Don't believe me, but watch

the papers and see if this is not so.

The Pope system, so called, is, as previously stated, nearly the same as the Schalke, the difference being in the shape of the cut, and that my barrels are cut to correct shape, while Mr. Schalke's were leaded. Mr. Schalke's rifling had eight flat grooves and eight narrow lands, with sharp corners to grooves. My rifling is here shown. (See Fig. 93.) It has eight wide grooves, which are on a radius about three times the radius of the bore, and has the corners rounded out, so dirt is easier removed, and it is cleaner in use. This groove is cut just deep enough to clean the bore in center and give a depth at corners of about .004 inch, which is about one-half the depth of the Schalke, but which is of ample depth, and works cleaner, and leaves less to depend on on upset of the bullet, and is therefore more reliable. The lands are very narrow (about one-fifth to one-sixth the width of the groove). The bullet is made with a base large enough to fill grooves completely, and the body of practically the same diameter as the bore. This gives a form that is gas tight, loads very easily (being assisted in this by the narrow lands and choke bore), and on upset, instead of the body of the bullet meeting only sharp lands and these cutting into the body of the bullet more or less unequally, it is immediately held in place by the nearly flat center of the broad grooves, and swells out into grooves equally and perfectly central; consequently is accurate.

In this system a false muzzle and starter are used, and the lubri-

cated bullet, seated from the muzzle, the shell with powder being afterward inserted in the ordinary way. In doing this the labor is very light, as the shooter has to handle nothing over a few ounces weight, the rifle standing in the loading stand. By the simple act of pushing the bullet home the sharp flat base of the bullet cuts the dirt down behind it, and does so exactly alike each time, giving a uniformly clean barrel without the labor of cleaning. This is also less labor than the ordinary way of seating a greased bullet in the breech, having to invert



Fig. 94

The Pope false muzzle and bullet starter

the rifle and generally sustaining its weight while so doing. The result of these things is that we attain all the accuracy of patched bullets, and in ordinary hands more, without the labor of cleaning.

Other things being equal, the man who tires himself least does the best shooting in the long run, and if this is accompanied by increased accuracy of the rifle, he has a great advantage over his fellows who do otherwise.

A properly made barrel, loaded in this way, will shoot 10-shot groups at 200 yards that will average about $1\frac{1}{4}$ to $1\frac{1}{2}$ inches less in diameter than the same or an equally good barrel shot dirty, bullet seated from the breech, while one using bullets seated in the shell is so far out of the game as to have no chance whatever on a string of any considerable number of shots, if otherwise he is an even match for his competitors.

One and one quarter to $1\frac{1}{2}$ inches does not sound much, but on the fine ringed targets now in use it means *points*. I have before me a good muzzle-loading group, .32 caliber, 10 shots, 200 yards. On German ring target it counts 250. Another group, shot breech loading, bullet seated in the breech, same load, is but 1 inch larger in diameter and is the best group I ever saw shot under these conditions. It counts 245. On the Columbia target the scores are respectively 12 and 21; on the Standard American 120 and 115. The difference between *average* groups is still more marked, averaging fully 7 or 8 points on German ring target. On this no comment is necessary.

For steadiness in shooting, I have fired 130 consecutive shots in 10-shot strings, measuring from centers of groups 104 inches, an average of exactly .8 inch per shot. The largest group was 3.75 inches across from center to center of outside shots, and measured $9\frac{1}{16}$ inches. The smallest group was 1.8 inches across and measured 6 inches. All but two of the shots would cut into a 3-inch circle.

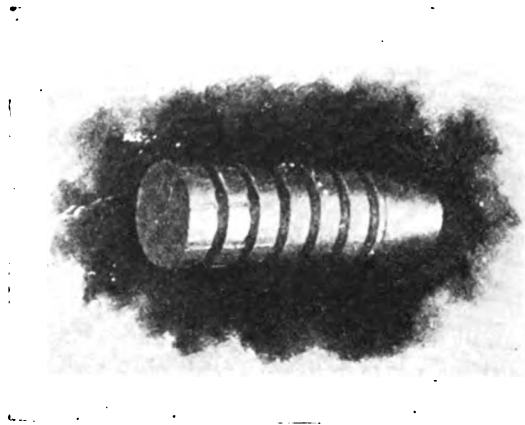

Fig. 95

Pope bullet loaded from the muzzle, showing smooth and perfect base

An advantage that a bullet loaded from the muzzle will always have over one loaded from the breech is shown in Fig. 95. This is an enlarged view of a .32-caliber bullet seated from the muzzle. Notice the perfect base, as the lands *cutting forward* into the bullet left it nearly perfect. Contrast it with a bullet seated in the breech by means of a bullet seater in the ordinary way (see Fig. 96). Here the lands *cutting backward* into the bullet *drag the burrs behind, leaving an uneven and serrated base*. If this bullet is not perfectly centered these burrs will be longer on one side than on the other. As these burrs leave the muzzle, the gas escapes first from the short side, tipping the bullet to the opposite side, in which it is assisted by the longer burrs holding the bullet back; the result is an uneven, wobbling flight. *The greatest essential for perfect shooting is to deliver the bullet perfectly from the muzzle; that being done, atmospheric conditions and gravity alone govern its flight; the result is accurate shooting.*

To illustrate, a group was shot at 200 yards, machine rest, with as perfect bullets as I could select, another on same holding with bullets

very badly mutilated at the point; these two grouped closely, a 3-inch circle holding all. Another group was then shot with bullets very slightly filed on one edge of the base, but otherwise perfect; this caused imperfect delivery, and the group was 8 inches in diameter. Weather conditions were good.

The base band of my bullets is broad and sharp, and of full size; the starter centers it perfectly, and fits it to rifling with a perfect base;

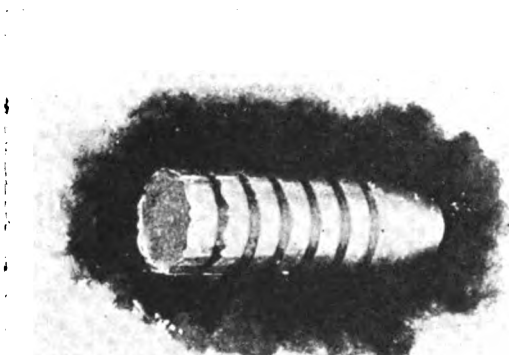

Fig. 96

Pope bullet loaded from the breech, showing burrs forced out on the base the shape of the grooves hold it central on upset, and it delivers perfect from the muzzle. No other method will do this.

My barrels are all (unless specially ordered) cut with a gain twist, and are so bored and rifled as to have a slight, but gradual, taper from breech to muzzle. This, besides keeping bullets perfectly under control, in connection with the narrow lands (which cut through the bullet easily), makes loading very easy, and very materially increases accuracy. A bullet pushed through from the breech is tight all the way, there are no loose places, and this result is attained by close, careful workmanship, no emery being used; the result is a barrel with a long life. Whenever practicable I chamber and make all cross-cuts before rifling; then I fit a bushing to the chamber and bore and rifle it with the barrel and false muzzle. As the rifling is then the last cut made in the barrel, I am absolutely certain that there can be no burrs across the grooves, a very common fault.

The advantages of the gain twist are two: 1st — The twist being less at the breech, gives less friction to the bullet; it therefore starts easier and quicker, giving the powder less time to burn on in front of the chamber, which therefore fouls less than in a barrel of uniform twist at the same necessary muzzle pitch. 2nd — The slight change in angle of rifling, in connection with choke boring, effectually shuts off any escape of gas and prevents gas cutting, which is another cause of imperfect delivery.

The advantages of the Pope system are briefly summed up as follows: 1 — Accuracy. 2 — Light labor. 3 — Seating the bullet centrally without deforming the base, and fitting it perfectly to the bore. 4 — The shape of the grooves holding the bullet central on upset. 5 — Non burning-on qualities of the gain twist. 6 — Perfect workmanship. 7 — Ability to load from either the breech or muzzle, and to clean and inspect from the breech. 8 — The ability to shoot any charge desired by inserting shell first, and loading both powder and bullet from the muzzle.

To produce the quality of work that I do, the methods employed in factories producing work in large quantities are impossible; that is to say, that this method of interchangeable parts must leave some leeway for slight inaccuracies to insure parts assembling. In my work such looseness of fit would be fatal to the results attained. False muzzles, for instance, it is utterly impossible to make perfectly interchangeable, neither is it possible for automatic machinery to produce the same quality of work as a skilled workman with brains behind. The automatic machine does more and does it cheaper, but the quality is not there. Therefore I do all nice work by hand, in the very best manner I know how. Nothing is slighted. This is slow work and takes expensive men. Naturally I cannot compete with factory work in price, but, quality considered, my price is very low.

The Pope muzzle loading outfit consists of barrel, false muzzle, starter, ramrod, Pope special muzzle-loading mould, and lubricating pump. Barrels will be furnished of almost any length and weight, within about 3 to 6 ounces limit of variation up to 8 pounds, 2 ounces, for 32-inch, No. 4 Octagon, .32-caliber barrel. I consider for 200-yard, offhand work a barrel of about 7¾ pounds, 30 inches long, and round as the best adapted. This I consider my standard, and recommend it as giving the best average results. For caliber for offhand work I prefer a .28, .32, or .33.

CALIBERS AND WEIGHTS

Caliber	Powder	M. L. bullet	B. L. bullet	200 yard guarantee
.25	26 grains.	98 grains.	86 grains.	3½ & 3 inches.
.28	30 grains.	118 & 138 grains.	108 grains.	3 & 2½ inches.
.32	47 grains.	180 & 200 grains.	165 & 185 grains.	3 & 2½ inches.
.33	47 grains.	195 & 218 grains.	..	3 & 2½ inches.
.38	55 grains.	277 & 330 grains.	255 grains.	3 & 2½ inches.
.39	55 grains.	265 & 343 grains.	..	3 & 2½ inches.

Note: The .33 and .39 calibers are recut from old .32 and .38 barrels and are adapted to muzzle loading only.

The weight of powder charges are the drawn shell full. This can be decreased by the use of everlasting or special shells, or by using less powder and an air space. Weights of B. L. bullets are those intended to seat in the shell. Barrels are cut with a pitch correct for the bullet they are intended to use. Shorter bullets can be used in a barrel cut for the long one, but not the reverse. It is oftentimes better

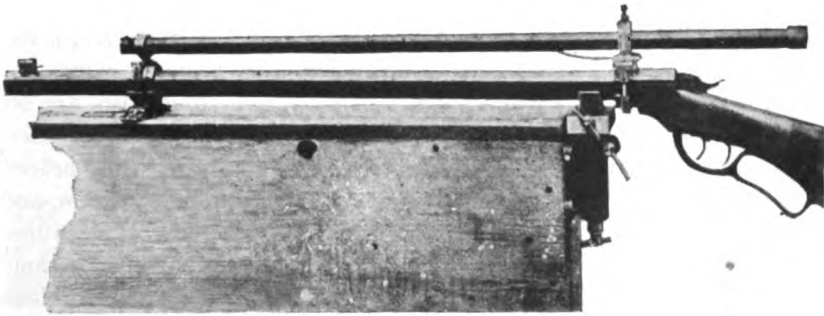

Fig. 97

Pope double machine rest with telescope sight, Ballard rifle in position for firing

to use the lighter bullet. Unless specially ordered I shall use my own judgment in cutting the barrel.

It will be noticed that two guarantees are given as to the size of the group at 200 yards. There is absolutely no difference in the qualities of barrel or workmanship. I have a long trip to make to test, and in my guarantee have to make allowance for adverse weather conditions, sometimes having to make several trips to the range to secure the desired results. I never alter a barrel in testing, it is a matter of ammunition only. If tested you see what has actually been accomplished with fine appliances, and know exactly what load did it. If untested, you, unless very expert, can hardly expect to equal at once the results of my machine rest, and may have to do some experimenting (when you become accustomed to the system, not before), to determine the

best temper of bullets, etc. You are liable to get as close a group on one guarantee as another, as it is largely a matter of weather conditions. If weather is good I get close groups; if weather is cold and wind tricky they are not so good. It is perfectly obvious that I cannot guarantee to furnish as close a group as the barrel is capable of shooting, though I might happen to do so. I believe all my barrels are capable of shooting closer than 2-inch groups with favorable weather conditions.

The Pope double machine rest is shown in Fig. 97. More information can be derived from its use in a few hours than can be had by ordinary rest shooting by an ordinary shooter in as many weeks, as, if at all carefully used, it has no human errors of holding and pulling. The results, therefore, are those due to rifle, ammunition, and weather only; the man is out of it except so far as his loading of the rifle and judgment of the wind are concerned. The mounts are all adjustable and clamp to the barrel, no screw holes or marring of the barrel being necessary. They take barrels of all ordinary sizes without change, the forearm being removed while testing. In use two stout posts are set deeply in the ground, the firmer the better, and are braced together. A smooth level plank is fastened on top. Both posts are firmly braced in two directions, stop is fastened on top plank in proper position, and rear rest to rear post so as to give approximately the correct elevation. Front rest and scope mountings are clamped to the barrel, the same loaded, and slid gently to stop. To sight on I prefer four black pasters placed at the corners of a square about $2\frac{1}{2}$ inches on a side. Adjust your rest or telescope, or perhaps both, so the gun points where you wish, cross-hairs being between each pair of pasters. Let the rifle rest naturally, hold right hand about 6 inches behind the butt, touch the set trigger with the left hand, and catch the rifle on recoil. If the gun has a heavy pull pinch the trigger and guard with thumb and forefinger so as not to disturb the rifle in rest. In setting up it is often convenient to set the rest so the rifle will point on the target before the telescope is mounted; using the ordinary sights, then mount the scope and adjust it to your pasters, and shoot your group, then move the rest a fair amount, that depending on how close the gun will shoot, then bring your scope again to the pasters and shoot again. It very seldom pays to try to get the rifle to shoot at any given spot in testing. Hold in one spot and get your group wherever it happens to fall.

A telescope sight is not a necessity in double rest shooting, though

it is a great convenience. With it you can shoot from a bench rest that is not firm, as the sight gives you a chance to correct the aim each time. For all that an absolutely firm bench is best, and if you shoot from a double rest without a scope it is an absolute necessity.

CHAPTER XXI

TARGET MEASUREMENT

IN order to compare the relative accuracy of various rifles, and the results attained at the target, some standard method of measuring the groups fired on the targets is necessary. The score made on any target will tell us little, because a rifle may often throw very wild shots, and thus be inaccurate, but a score may be made up of a number of very close shots, and a few very wild ones, and yet record a high score. When we fire a group of shots to determine the accuracy of a rifle, or of a certain kind of ammunition, the group usually includes ten consecutive shots, and we arbitrarily say that the rifle or ammunition is as accurate as the wildest of these ten shots, because if we were to fire one single shot with a view to hitting a certain object we could not be positive that it would strike closer to the object than the wildest of these shots.

The most usual method of measurement, and the one most satisfactory to a majority of riflemen, is to determine the diameter of the circle which will include the center of all ten shot holes of the group. We then say that the rifle or ammunition is capable of firing ten consecutive shots into a circle of such a size, or that it will make such a sized group at such a range. In order to measure a group in this manner it is necessary to make but one measurement, that is the distance in inches and decimals of an inch between the two shot holes of the group that are farthest apart. The most practical method of making this measurement is to place the target containing the group on a sheet of paper, and with a needle carefully prick holes through the center of the bullet holes farthest apart into the sheet of paper. The center of the bullet hole can, as a rule, be located by the eye alone accurately enough. Then remove the target, and with a triangular, boxwood, engineer's scale reading to fiftieths of an inch, measure the distance between these two needle holes. Fig. 98 illustrates this method clearly.

For the purpose of more accurately determining the relative accuracy of various kinds of ammunition we have another method in vogue,

particularly in the Ordnance Departments of the various armies; that of determining the mean radius of the group. The mean radius of the group is the average distance that the shots of the group strike from the center of impact. The center of impact is the average center of the group. First we must determine the center of impact, and then measure the distance of the center of each shot hole from it, and then take the average. To find the center of impact we must first find the horizontal center line, and the vertical center line passing through the group, and where these two lines cross will be the center of impact.

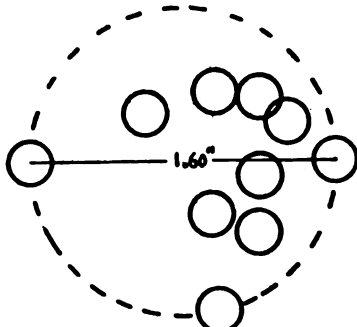

Fig. 98

Showing the method of measuring a group of shots to determine the size of a circle which will contain the centers of all the shot holes.

Suppose our rifle and ammunition has fired the group of ten shots, illustrated in Fig. 99. We must first find the

mean vertical deviation. With a square draw a horizontal line through the center of the lowest shot on the target. All the shots on the target are then numbered consecutively, starting with the highest above this base line. The distance from the base line to the center of each shot is then measured in inches and hundredths of an inch on perpendiculars to the base line on these centers. The total of all these distances (there will be nine of them, because the shot which the base line passes through has no measurement) are then added and divided by the number of shots on the target (ten in this instance). The dividend then represents the distance from the base line of a parallel line that is the mean vertical center of the group. This vertical center line is then drawn on the target, parallel to the bottom base line.

Now draw a vertical line at right angles to the vertical base line (horizontal line at bottom of group) passing through the center of the left-hand shot of the group. From this line measure the horizontal distance to the centers of each of the shots on the target, and divide the sum of these measurements by the total number of shots in the group. This dividend represents the distance from the horizontal base line of a parallel line that is the mean horizontal center of the group. Where the mean vertical center line, and the mean horizontal center line cross each other is the center of the group, or the "center of impact." It is indicated in Fig. 99 by a cross, the continua-

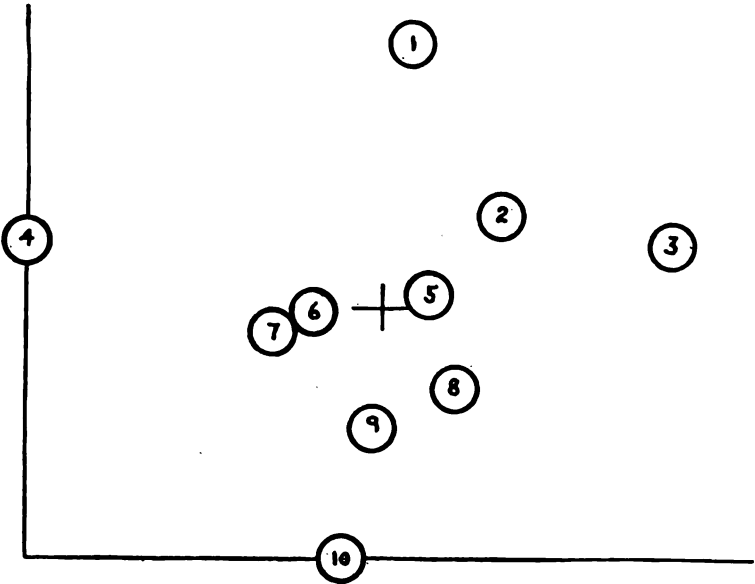

Fig. 99

Method of computing the mean radius of a group

Number of shot	Vertical deviation	Horizontal deviation	Absolute deviation
1	2.70 inches	2.00 inches	1.38 inches
2	1.70 inches	2.47 inches	.78 inch
3	1.63 inches	3.60 inches	1.54 inches
4	1.65 inches	1.88 inches
5	1.40 inches	2.10 inches	.25 inch
6	1.30 inches	1.50 inches	.36 inch
7	1.20 inches	1.28 inches	.58 inch
8	.90 inch	2.22 inches	.55 inch
9	.70 inch	1.80 inches	.62 inch
10	1.63 inches	1.32 inches
Mean.....	11.318 inches	1.860 inches	.926 inch

Mean radius .926 inch. Cross indicates center of impact

tion of the two center lines being omitted for the sake of clearness.

Note that the vertical base and vertical center lines are drawn on the target as horizontal lines, and the horizontal base and horizontal center lines are drawn as vertical lines.

Now measure the distance from the center of impact to the center of each shot hole, and add these measurements together, and divide by the number of shots in the group. The result will be the mean

radius, or mean absolute deviation of the group. The smaller the radius, of course, the better the group.

In testing ammunition at long range, as, for example, the tests held in the United States for the purpose of determining the most accurate ammunition for the national matches, the mean vertical deviation only is taken by measuring the distance of each shot from the vertical center line on perpendiculars to that line. This is done because at long range the variation due to the wind would make a considerable horizontal deviation of the various shots of the group, and this would not be constant for the various lots of ammunition tested.

At 1000 yards these ammunition tests are fired on the regular 1000-yard target which is 12 feet long and 6 feet high. The various boards conducting these tests have made it a rule to assign an arbitrary measurement of 72 inches for every shot fired which does not hit the target.

CHAPTER XXII

ADJUSTMENTS AND REPAIRS

Adjusting trigger pulls. Rebluing a rifle barrel. Repolishing rifle stocks. Repairing broken stocks. Checking stocks. Extracting broken shells. Removing stuck cleaning rods and patches. Measuring the bore of the rifle. How to make a sulphur mould. Muzzle wear.

ADJUSTING TRIGGER PULLS

GOOD marksmanship depends to a great extent upon the perfect control of the trigger. The pull of the trigger must be such that the rifleman can always tell just how much pressure he must exert to discharge the rifle, and it must always be constant. As the rifles come from the factory very little has been done in the way of adjusting the pulls, except on Winchester and government arms. Winchester arms, however, while having good, clean pulls, almost invariably have trigger pulls much heavier than is desirable, and occasionally a government arm is found that has a pull which needs smoothing up.

Rifles intended for target shooting exclusively usually have set triggers. These consist of two triggers. Pulling the rear trigger sets the front trigger, and the front trigger then pulls off clean with a couple of ounces pressure. If the rear trigger be not set, the front trigger acts as a regular trigger. Between the two triggers there is a small set screw, and by turning up or loosening this the set trigger can be made to pull off at any weight. This form of trigger requires no special explanation.

The plain trigger is the one almost invariably seen on military and sporting rifles. An experience in many years of rifle shooting has taught us that the best pull for such a trigger is one that requires from $2\frac{1}{2}$ to $3\frac{1}{2}$ pounds pressure to release the hammer or cocking piece and discharge the rifle. Also this pull should be clean and sharp. That is to say, there should be no drag, grate, or movement to the trigger before the rifle is discharged. The trigger should stand absolutely immovable until the requisite pressure is exerted, and then it should give away all at once, the rifle going off, something like the breaking of a thin rod of glass.

There are two forms of plain-trigger pull, which we may call the

sporting-rifle pull, and the bolt-action pull. With the former the trigger may be either pressed against the hammer or sear by a spring, and be practically immovable all the time until the requisite pressure has been placed upon it, or it may be loosely hung in the guard, and when the pressure is first applied by the trigger finger the trigger at once moves back against the sear or hammer, and thereafter is immovable until the full pressure has been exerted.

The bolt-action pull is slightly different from this. There is first of all a safety pull or movement to the trigger. When force is first applied to the trigger by the finger the trigger moves to the rear from $\frac{1}{8}$ to $\frac{1}{4}$ inch upon the exerting of a pressure of about $1\frac{1}{2}$ pounds, and thereafter is stationary. Then it takes several more pounds pressure upon this stationary trigger to fire the rifle. The principal difference between the sporting-rifle pull, and the bolt-action pull is that with the first named the trigger is practically stationary from the time that the first ounce of pressure is applied until the rifle is discharged, and with the second named the trigger first moves to the rear a little before the real trigger pull starts. It takes a little time for one used to the sporting pull to become accustomed to the bolt-action pull, but after it is mastered one is practically as good as the other. The rifleman using the bolt-action pull simply gets used to grasping the trigger at once with sufficient pressure to take up all the safety pull and move the trigger to the rear, and thereafter the pull of the two are exactly the same.

As the rifle comes from the factory the pull may need either lightening, or smoothing off to eliminate creep, or both. An examination of the mechanics of all triggers will show that there are but two parts concerned in the pull, the sear, and the notch in the hammer, or nose, of the cocking piece. The mainspring is kept compressed by the sear bearing against the notch or nose. When the sear is dragged away from this notch or nose the mainspring causes the hammer or firing pin to fly forward. The weight of the pull depends upon the angle at which these two surfaces come together, and the drag or creep depends upon the depth to which the sear enters the notch in the trigger or bears against the nose of the cocking piece.

To lighten a trigger pull and eliminate a drag or creep, certain things are needed. Several sheets of fine emery paper, a small, thin slip of oil stone, a little lubricating oil, and a small spring scales like the scales used by the fisherman for weighing fish, which will weigh as close as a quarter pound. To weigh a trigger pull, place the hook of

the scales over the trigger, exerting the pull in the same direction that the trigger finger will act in pulling the trigger. Apply tension gradually, keeping the eye on the graduations on the scale, and noticing at what weight the sear releases the hammer or cocking piece. This gives the weight of the trigger pull.

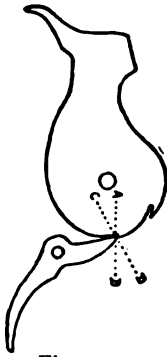

Fig. 100

If it is desired simply to lighten the pull, examine the surfaces of the sear and notch or cocking piece carefully. It will be noticed that they come together something like the surfaces A-B in Fig. 100. In order for the sear to release the hammer or cocking piece it is necessary for it to act against the tension of the mainspring. Now if these two surfaces be ground off so as to come together on the lines C-D; not so much pressure will have to be exerted against the force of the mainspring and the pull will be lighter. Dismount the various parts and proceed gradually and carefully to grind off the two surfaces to conform to the angle C-D, being sure to keep the grinding level, and not to grind one side more than the other. Go very slow, and assemble the parts often and try the pull with the scales. Sometimes as many as five or six light strokes on the oil stone will make a great difference in the pull, and the whole secret of the thing is to grind very carefully, and try the pull very often. Usually very little grinding is necessary to lighten the pull to the desired amount, and also usually the novice grinds off entirely too much at the first attempt, and spoils one of the parts and has to send to the factory for other parts. Remember to go very slow, and try often.

To eliminate the creep or drag, it is necessary either to polish the two surfaces of the sear and notch or nose so that they slide smoothly over each other, or else so to grind the two parts that they slide a shorter distance before the release comes. Polish the two surfaces with the emery cloth until they are perfectly smooth, like glass, but do not attempt to grind at all at first. If this does not eliminate the creep, then the two parts must be so ground that they

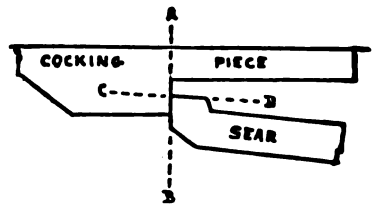

Fig. 101.

Polish the surfaces on the line A—B where they bear against each other. If this does not give the desired result, start very carefully and slowly to grind down the upper surface of the sear on the line C—D, assembling the parts and testing frequently.

have a shorter distance to slide over one another. Do not in any case attempt to lessen the width of the notch in a hammer, as this will almost always simply result in the hammer sticking in the half-cock notch when the trigger is pulled, instead of falling all the way and driving the firing pin forward. Instead, work on the sear, so grinding it that it will not enter quite so far into the notch, or project up against the cocking piece.

On a bolt-action rifle, first polish the surfaces of the sear and cocking piece where they bear against one another, being careful not to wear them, nor to alter the angle at which they bear against each other. If this does not improve the pull to the desired extent, commence very carefully and slowly grinding off the top of the sear so that it does not project up so far and engage so much of the cocking piece, but go very slowly, and put the parts together and try often. In this way the pull can be refined to the desired point. See Fig. 101.

REBLUING A RIFLE BARREL

One often wishes to reblue the barrel of a rifle which has become worn, or which has been cut with slots and screw holes for various sights or telescope sight mountings, and it is desired to hide these cuts or holes. To fill in old screw holes, obtain well fitting screws of the same pitch of thread as the holes in the barrel. File off the points of these screws so that they have square points. Carefully clean *all* oil out of the screw holes in the barrel, and also off the screws. Screw these screws tightly into the holes, and then cut them off either with a file or hack saw, so as to leave not over $\frac{3}{4}$ of an inch of screw projecting above the surface of the barrel. If using a hack saw for this purpose be sure to use the saw only in such a direction as to tighten the screw and not to loosen it. Now, using a light hammer with a small round point or pene, hammer the ends of the screws down smooth with the surface of the barrel so as to make a tight joint, and a smooth surface that one will not be able to detect after the bluing has been done.

Next you must have some bluing or browning solution prepared. Have this done by some first-class druggist, and tell him what you wish the solution for, as the promiscuous sale of some of the ingredients is prohibited in most States.

Spirit of nitre	3 drams
Tincture of iron	3 drams
Sulphur	1 dram
Blue vitrol	2 drams
Corrosive sublimate	1 dram
Nitric acid	$\frac{1}{2}$ dram

Copperas	1 dram
Distilled water	12 ounces

Have it put in a colored glass bottle a week or two before you want to use it, and be sure to label it "POISON."

All the old finish, bluing, and rust spots on the barrel must now be removed by scouring it with emery cloth and steel wool. Oil the barrel well inside with heavy grease like cosmic or any thick gun grease, and plug up both the breech and muzzle with strong wooden plugs which project out of both the breech and muzzle two or three inches. These plugs are to serve two purposes: first, to prevent the bluing solution from getting into the bore and rusting it; and, second, to handle the barrel with during the bluing process. Both plugs should be well saturated with oil where they enter the bore.

One must get absolutely every bit of the oil off the outside surface of the barrel, and then neither the hands nor any oily thing must touch the barrel during the treatment. To get all the oil off it is best to wash the exterior over with a solution of lime and water about as thick as thin cream. Let this dry on, and then remove with clean, dry cloths that are perfectly free from any oil. Woolen rags should not be used as they are of an oily nature.

Now apply the bluing solution by means of a swab made by folding up an *old, clean* piece of canton flannel to about 6 thicknesses, and holding this in a split stick or clothes pin. Keep the solution well stirred up, and above all keep it away from the clothes and hands as it will burn badly. Go over the barrel with long strokes from one end to the other. Set the barrel away for 24 hours in a rather damp place, not a steam-heated house, and then wipe off the rust or residue with a clean rag large enough so as not to touch the barrel with the bare hands or fingers. Of course the rag should not have a trace of oil on it. Then apply another coat of the bluing solution, applying a coat each day, after wiping off the rust of the past 24 hours. The number of such treatments necessary will depend upon the amount of moisture in the air, and the character of the steel. Ordinary steel and a damp climate will require about 6 treatments on 6 successive days. Nickel steel will require about 12 treatments unless it is very damp. A non-corrosive steel like "Poldi anti-corro" may require as many as 30 treatments to get on the required coat of rust. Wipe off the free rust only each day; that is, only the loose rust, but not all the color. Wipe evenly and gently, or the surface may look patchy. The thing is to

continue applying the solution, and allowing the rust to form, until the color desired is acquired, usually a rich dark brown.

At last, when this color is acquired, wash the barrel very thoroughly with boiling water to remove all further rusting action. Do not be afraid to use plenty of boiling water. Then go over it evenly and gently with soft, dry cloths until the surface is bone dry. Now while the metal is still hot, and the surface dry, apply liberal quantities of linseed oil with woolen cloths, covering the barrel evenly with long, gentle strokes, and gentle pressure. It is quite easy to remove the bluing in spots by hard rubbing at this stage.

Watch the barrel for a few days to see if further rust action takes place. Should it do so, at once wipe off the oil and apply more boiling water, dry carefully, and again apply the linseed oil. Future applications of the linseed oil will help to deepen the color and prevent rust. *Do not slight any of the operations.*

REPOLISHING RIFLE STOCKS

The ordinary stock on the straight American factory rifle is not polished. It is simply varnished. Some high-grade stocks are likewise varnished with a glass-like finish. A varnished stock is an abomination. It looks well when new, but a few weeks of field service covers it with scratches which cannot be obliterated by any amount of rubbing with oil. And when the varnish is worn off such a stock it absorbs water and warps badly. The best stocks are finished or polished simply by repeated rubbings in of raw linseed oil, this finish being given the trade name of "dull London oil finish." Well done in this manner, the stock shows its grain beautifully, has a dull, rich, velvet-like surface which persists, resists dampness splendidly, and if it becomes scratched the scratches can be almost entirely obliterated by a rubbing with raw linseed oil. This is the finish which all stocks and forearms should have.

It is an easy matter for any one to repolish a stock in this manner, and it adds much to the appearance and serviceability of the rifle. Go to a paint and oil shop and purchase half a pint of varnish remover, and a pint of raw linseed oil. Also get several sheets of medium, fine, and very fine sandpaper. Remove the stock and forearm from the rifle, and take off butt-plate and all metal parts. With a brush or cloth wet the stock all over with the varnish remover, and let it soak in for half an hour, then rub off. One or two applications of this will suffice to remove all the varnish. Then scrub the surface of the wood

all over with water, wetting it thoroughly. This will raise the grain of the stock, making it look "fuzzy." The wood should then be dried quickly by holding it over a stove, or passing it over a lamp. This will help to raise the grain still further. Then sandpaper off the raised grain or "fuzziness," using the medium-grade sandpaper. Repeat this process of wetting, drying, and sandpapering four or five times, the last time or two using the fine and very fine sandpaper for the polishing. The object of this is to get a permanent, very smooth, velvety surface on which the grain will not raise up when the wood becomes wet. When you can no longer raise the grain by wetting the wood and drying, dry it thoroughly, give it a fine polish with the very fine sandpaper, and set the stock away over night in a dry place.

We are now ready for the oil finish. Pour about a teaspoonful of raw linseed oil on the surface of the wood, and polish it with the palm of the bare hand, rubbing the oil well into the wood, and continuing the rubbing without stopping until the oil is all rubbed in, and the wood becomes dry and warm from the friction. Repeat this rubbing with oil time after time on every part of the stock and forearm until the finish desired is attained. The excellent finish seen on very expensive stocks is attained in this manner, sometimes as many as thirty or forty coats of oil being rubbed in by hand. Once the stock and forearm have been polished in this manner all they will need to keep them in perfect condition and appearance is an occasional polish with the raw linseed oil. This should be done every time the rifle gets wet with rain or perspiration. The checked portion of the stock and forearm, and the cuts into which the metal work of the receiver and barrel fits, can be polished by oiling with a tooth brush. Do not rub hard enough on the checking to dull it. Before assembling the stock and forearm to the rifle, it is well to coat the cuts which the tang and guard fit into, the surface of the wood under the butt plate, and the inside of the forearm with beeswax or some very heavy grease like Winchester gun grease or Corol. Walnut has become so expensive and scarce lately that many ordinary stocks are now made of other woods. These may require the application of a dark walnut stain before the oil is applied.

REPAIRING BROKEN STOCKS

Stocks sometimes break at the grip. This nearly always occurs as a result of an accident on a hunting trip, and if the trip is not to be spoiled the stock must be mended with the materials at hand. If one has any large nails file off the heads of a couple and point each end

sharply. Use them as dowel pins, inserting one end in the grip portion above the break, and the other end in the main portion of the stock, drilling holes for them with an awl or gimlet. The pins should run lengthwise with the grip. Press and drive the two portions of the stock together. If you have any canoe glue along, this may be used also. Next take two common table knives from the kitchen outfit, remove the wooden handles, and file off the guards on one side. With a pen-knife cut a shallow recess on each side of the grip so as to sink the knives into the surface of the wood so that their surface which has had the guard filed off shall lie flush with the surface of the wood. Then tightly wrap the whole grip over the knives and for quite a distance above, below, and over the break preferably with copper wire, or fish line. Or a piece of raw-hide can be soaked in water until it becomes supple, wrapped tightly around the grip, and strongly sewed, allowing it to dry in place and tighten. This will make a strong, stiff repair, and the rifle will be serviceable again. Many of the explorers and trappers of the Old West used to wrap their stocks in several thicknesses of green raw-hide, tightly sewed and laced on. When this covering dried it became as hard as iron, and very tight, and it made the stock practically unbreakable. Every hunting outfit except the very lightest should include a file, a small tool handle containing awls, gimlet, screw-driver, etc., a coil of copper wire, and a small box of assorted nails and rivets. These will come in handy for many different repairs. Of course every outfit has a knife and whetstone.

CHECKING STOCKS

The rifleman may sometime wish to check a rifle stock. He may have a perfectly plain factory rifle with plain stock, and the checking will improve the looks greatly, and at the same time make the grip more secure. Or it may be that he is remodelling a military arm into a sporting rifle. The operation of checking a stock or forearm is not so difficult as it would seem, any one who will take a little pains, care, and time can master it. No special skill is required other than a good eye and a little practice. The following methods of checking I have evolved myself, and they have worked so well that my third attempt was practically as good as the factory product. The only tools necessary are a checking tool shown in Fig. 102, a small jeweler's file, and a flexible ruler such as a piece of steel tape or celluloid. My own checking tool was made from a square rod of tool steel $\frac{3}{8}$ inch square. One end was heated and bent to the shape shown, the teeth cut in with

a file, and then tempered. A cartridge shell was fitted to the other end as a handle. The small jeweler's file should have a sharp edge (the half-round pattern does very well), and is for cleaning up the corners of the checking where it is difficult to reach it with the checking tool. Make the teeth on the checking tool the correct size for a medium-size diamond such as is seen in Winchester stocks. A small diamond is too trying on the eyes to cut, and a large diamond shows all the mistakes of the amateur.

Practice on several odd pieces of walnut or similar wood before trying to check a stock. It takes a couple of hours to become fairly proficient at cutting the lines straight, of even depth, and of even slope on each side. Rule the first line in either direction with pencil and flexible ruler, taking care that the two lines make the correct angle with each other so as to get a properly shaped diamond. Grasp the tool with the index finger lying just above the curve. Tilt the tool a little to the right so that only one set of teeth will cut at first, and cut the first line, following the pencil line with great care, and making the first cut merely a scratch. Then deepen this scratch just a little with succeeding cuts. It is important that the first scratch be exactly right as the tool will afterwards follow that, and if it be crooked the final cut will be crooked. If you get the first scratch crooked it is very difficult to straighten it. The motion of cutting with the tool is similar to that of filing. When the first groove is about half cut it acts as a guide for the next. Go on with the cutting but gradually lean the tool over to the left so that it will begin to cut a groove on the left of the first groove. Do not cut any groove to its full depth at first as you are tilting the tool all the time in cutting one groove after another and you would not finish them up with an even slope on each side. Cut all the grooves first to about half the depth required, then go over the work again, this time holding the tool straight up and down so that both sets of teeth cut evenly, and cut each groove to the required depth. When you can make fairly perfect diamonds and border on a piece of wood, working on both a flat and rounded surface, you are ready to undertake the actual operation on a rifle. Remove the stock and forearm from the rifle, and remove the butt plate and all metal or rubber parts. If the wood has been polished or oiled, remove the oil with a varnish remover, wash the stock, smooth it down with very fine sandpaper, until you get a smooth surface of plain walnut without any polish.

Start on the forearm first, as it is much easier than the grip of the

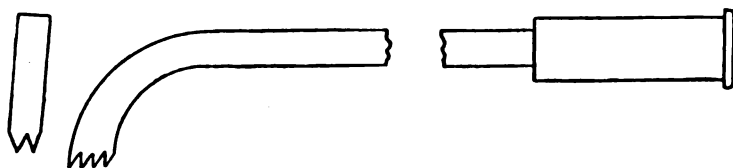

Fig. 102



Fig. 103



Fig. 104



Fig. 105



Fig. 106

stock. With the flexible ruler lay off the outline of the checking you desire in pencil lines. Be sure that this outline is so laid off that the resulting diamonds of the check will be of the correct proportions. The tendency of the amateur is to make them too square. The border of your pattern should be a single pencil line which is cut into a double line with the checking tool. The diamonds are to be cut only up to the inside of the two border lines. This makes the very neat border seen on Winchester stocks. Fig. 103 shows the first pencil outline. Cut that portion of this outline into a double line as shown by the full lines in Fig. 104 first, but do not cut that portion of the border shown by dotted lines at all at first. Next, prolong the inside, single, full, border line on either side of the forearm at the rear until they cross as shown at A in Fig. 105. Then proceed to cut lines parallel to these, and the diamonds will start to form at A and develop from there outward as each parallel line is cut. The first two lines to cross each other are the guide lines. This procedure insures getting perfect diamonds throughout the whole work and you do not have two lines forced too close together. When you have finished cutting the diamonds in the space B, Fig. 105, cut the border lines adjacent

thereto indicated by the dotted lines. Similarly when the diamonds approach the dotted lines representing the forward border lines, cut those lines. The border represented by the dotted lines must be dependent for its exact location upon the diamonds adjacent thereto, otherwise the two may not meet exactly, or the lines may not come out parallel, either of which will make a poor looking job. All this seems a little ambiguous in print, but as the work progresses one will easily understand it.

You will find it difficult to reach with the checking tool into the extreme triangular corners of the patterns. These should be dressed out carefully with the point of the file.

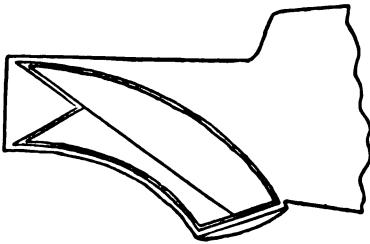

Fig. 107

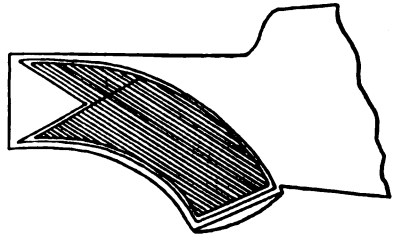

Fig. 108

In checking the pistol grip the procedure should be slightly different. Here you should lay out and cut all the double border lines first. Then cut one diamond line across the entire middle of the pattern by prolonging one of the inside border lines as shown in Fig. 107. Then cut lines parallel to this one over the entire pattern. Then prolong the other inside border line in the opposite direction as shown in Fig. 108, and complete the diamond lines in this direction, thus finishing the checking.

You will find it difficult at first to cut the lines exactly parallel when working over a curved or rounded surface. They will tend to curve off in one direction. You must watch this closely, constantly lining up the work with your eye, and making the small, almost infinitesimal allowances and corrections which will prevent this. Do not cut the grooves quite as deep as desired at first, and be careful that your tool does not slip, especially at the end of a groove, and when approaching the border. Try to get the grooves of a uniform depth.

Having completed the checking almost deep enough, brush out all dust from the diamonds with a tooth brush, and give the checked surface a slight coat of oil. When this oil has dried all the irregularities

in the checking will be clearly seen. If you have done your work carefully these irregularities will only be in the depth of certain parts of the checking, and the size of the tops of the diamonds. With the checking tool go over again all the shallow places until all is uniform, and with the small file dress up all the corners, and ends of lines, and your checking is complete.

EXTRACTING BROKEN SHELLS

Once in a great while a shell will break in the neck or body upon being fired, and, parting, the forward portion will be carried up into the rifling, or into the neck of the chamber, and be so firmly lodged there that it defies all ordinary attempts to remove it. The base of the shell, with the head attached, is of course easily extracted in the ordinary manner. This trouble is much more liable to occur with straight or straight-taper shells like the .32-40, .38-55, and .45-70 than with the modern bottle-necked shells using smokeless powder. And it is also more liable to occur with old shells that have been loaded for a number of years than with new cartridges. When anything happens to a smokeless powder cartridge having a bottle-necked shell, it is almost always a longitudinal crack at the neck, the shell practically never being broken in two pieces, and this occasions little trouble. Trouble is found mostly with old .45-70 cartridges that have been in store many years, the shells having become corroded around where the base of the bullet meets the powder, and when fired the bullet pulls the shell apart and takes the forward portion with it up into the throat of the chamber, or even into the rifling.

Of course when this happens the rifle is temporarily useless. Both the Ideal Manufacturing Company, and the Marble Arms and Mfg. Company make little broken-shell extractors designed to extract broken shells. These are little steel tools shaped somewhat like a cartridge shell, having the same head so that they can be operated by the bolt or breech-block of the rifle, and extracted in the ordinary manner. When inserted in the chamber they slip inside the broken shell. The rifle is closed and they wedge fast to the shell, and when the rifle is opened the broken piece extracts with them. With the Ideal extractor, when it is inserted in the chamber the barrel should be pointed downward in a vertical position, and the muzzle pounded lightly on the floor once or twice to cause the little steel ball inside the extractor to run down and force the extractor to grip the broken shell. If the shell sticks very tightly it may be necessary to assist

the bolt in withdrawing the shell by inserting the cleaning rod from the muzzle, and striking the end of the rod with a hammer while force is being applied to the action to open it.

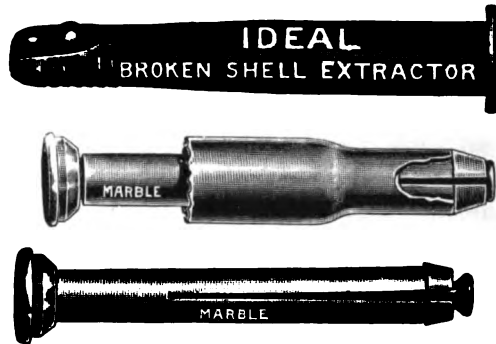

Fig. 109

The Ideal broken shell extractor
The Marble broken shell extractor

These extractors work very well when the broken shell has lodged in the chamber or in the throat of the chamber, but of course they will not act at all when the broken portion has been carried up into the rifling. The Ordnance Department of the Army furnish a little broken shell extractor to force out pieces of shell which have been carried up into the rifling. It consists simply of a small cylindrical piece of steel which perfectly fits the bore of the rifle, having lands on it which correspond to the grooves of the rifle, so that when it is inserted in the bore it fully fills the bore everywhere. This is inserted in the muzzle of the rifle, and pushed down on to the broken shell with the cleaning rod. A few blows on the cleaning rod then suffice to drive both the broken piece and the extractor out at the breech. This extractor is made only for the .30-caliber, government arms with the regular 4-groove government standard of rifling, and cannot be used in any other rifles.

If a portion of the shell should be carried up into the rifling and stick there, procure a short piece of brass rod, such as a piece filed off the end of the cleaning rod. Upset it slightly by pounding it on one end with a hammer until it is just about the size of the bore to the bottom of the rifling, and flat and square cornered on the pounded end. A tap with the hammer will suffice to drive this brass plug into the bore at the muzzle, it taking the impression of the grooves of the

rifling, and fitting the bore perfectly. It can then be driven down on top of the piece of broken shell with the cleaning rod, and the broken shell and piece of brass driven out at the breech.

On a hunting trip I always carry a broken shell extractor in the recess in the butt of the rifle. If the rifle has no trap in the butt-plate, the butt-plate can be removed, a small hole bored in the butt and the broken shell extractor placed therein, running in some melted beeswax around it to keep it from rattling and rusting. Also I always carry a short piece of brass rod about one-quarter inch in diameter and five inches long. This comes in handy for knocking front sights in and out of their slot, for driving nails out of shoes, etc., and a short piece can always be cut off for extracting broken shells.

The breaking of shells in this manner is very infrequent indeed in these days. In fact in all my experience I have only seen one case of it, and that was nineteen years ago with a .45-caliber Springfield rifle using black powder.

High-power cartridges which have been in store for a long time frequently break longitudinally at the neck, but this causes no trouble at all. Ammunition which is known to do this, however, should not be used, as the chamber will ultimately become badly gas cut from repeated splitting of shells.

REMOVING STUCK CLEANING RODS AND PATCHES

It often happens that, in the process of cleaning the rifle, the cleaning rod and patch become stuck in the bore, and cannot be forced out. This is almost always the result of carelessness, and is caused by using too thick a patch, or a patch of poor material which the rod punctures. Patches should be carefully cut to the correct size, and should be of good material, preferably of canton flannel, or of any thick flannel. It will add to the absorbing qualities of the material if it be thoroughly soaked in water several times and hung up to dry without wringing out. Do not use pieces of old underclothing, or other poor and thin material which the tip of the cleaning rod is apt to tear or penetrate. The patch should be of such a size that it requires approximately five pounds pressure to push and pull it through the bore. It should go through easily without force.

If it happens that a cleaning rod becomes stuck in the bore do not attempt to use force to pull or drive it out. By doing so one is very liable to injure either the bore or rod, probably both. Instead, at once pour some thin lubricating oil in at the muzzle of the bore, standing

the rifle up and letting the stuck patch get thoroughly soaked with oil. Then after about an hour's soaking from the muzzle reverse the rifle and pour the oil in from the breech, and let the patch soak again in this position. Both the patch and the entire bore thus become soaked and lubricated. After this the cleaning rod and patch can usually be easily pushed or pulled out of the bore. If, however, they should still stick tightly it will be necessary completely to dismount the barrel, taking off the forearm. Place the barrel above a gas or oil stove and heat it, being careful however not to heat it hot enough to injure it or the bluing. It is not necessary to heat it very hot. Three or four minutes in the flame of a small gas burner, or a small oil stove will suffice. This heat expands the bore slightly, and slightly chars the patch, and it can then be readily pushed out.

Never attempt to use a patch which seems to start tightly into the bore. Pull it out, discard it, and use slightly smaller pieces. Remember that when you are using ammonia for cleaning, and are drying the ammonia out of the bore, the second and third dry patches that you use after the ammonia patches, or the ammonia soaking, should be quite a little smaller than the others or they will stick. By using these precautions, always using good flannel, and taking care as to the size of the patches, I have never had a rod stuck in the rifle, but I have often been called upon to remove rods and patches which novices have managed to get securely stuck through lack of knowledge as to the precautions to be taken.

MEASURING THE BORE OF THE RIFLE

Throughout this work the "groove diameter" of the bore has been frequently referred to, meaning the diameter of the inside of the barrel, measuring from the bottom of one groove to the bottom of the opposite groove. This diameter is quite important when working up an accurate load for a rifle, because it indicates the exact size and fit of the bullet which will do the best work as a rule. The groove diameter of a barrel varies considerably, even in rifles chambered for the same cartridge. This is due chiefly to speed of manufacture, and wear of drills and cutters. I have measured a number of .30-caliber barrels which had measurements running all the way from .308 to .311 inch, the standard being .308 inch. It is always desirable to find out the exact diameter by actually measuring the bore, and not to trust too implicitly that it is exact standard.

In selecting a barrel one of the things we should look for is evenness of bore. The bore should have no tight or loose places. A rifle will do its best work if it is a perfect cylinder from breech to muzzle, not of course taking into consideration the grooves. Some riflemen think that a very slight taper from breech to muzzle, tighter at the muzzle than breech, is even better than a straight cylinder, and at least it can do no harm if it is not too pronounced. Such taper, except in Pope muzzle-loading barrels, is always accidental; all our barrels being designed to be a true cylinder.

To determine the size and evenness of the bore it is necessary to push a lead bullet through it, and then to measure that bullet with a micrometer caliper which reads to thousandths of an inch or finer. For this purpose a soft lead bullet is best, and it should fit the bore rather tightly. For the .30-caliber a lead bullet for the .32-20 cartridge does excellently, as it is .003 larger than the standard .30-caliber size, and is made of almost pure lead. The barrel should first be well cleaned, and then lubricated with a thin oil like "3 in 1" or sewing machine oil. The bullet is then inserted point first into the chamber, and very carefully seated in the rifling a little ahead of the chamber. Then place the rifle in a very heavy vise, like a carpenter's wood vise, fastened to a heavy bench. Take a strong cleaning rod almost the diameter of the bore, and with a powerful, but very steady pressure, push the bullet through the bore with one motion, noting the pressure which it takes to send it through. After a little practice one can tell by the pressure whether there are any tight or loose places in the bore. As the bullet emerges from the muzzle, catch it carefully so that it will not be in the least deformed, and measure it carefully with the micrometer, measuring the maximum diameter where the bullet has fitted down into the grooves. This will give the groove diameter of the barrel, usually the diameter near the muzzle. To obtain the diameter at the muzzle and breech insert a bullet into either end just a little way, place the end of the cleaning rod against it, and give the rod a sharp blow with a hammer so as to fully expand the bullet to fit the rifling at this point, but not to drive it far forward. Then insert the cleaning rod at the opposite end of the bore and carefully push out the bullet, and measure it. To determine whether the bore is choked or not, force a bullet through in one direction and note the force and feeling, and then reverse and force one through in the opposite direction. All this takes a little

skill, but it is easily learned. The main thing is to see that the bullet is not deformed as it leaves the bore. A little fall, or jam will considerably alter the dimensions of a soft lead bullet.

In using a micrometer caliper do not use any force in screwing it up. The tool usually has a ratchet click to the screw handle, and the correct pressure is being applied to the screw to give the right reading when this ratchet has clicked once or twice. Before starting in to measure, standardize the micrometer by measuring something of known diameter. The .30-caliber, 150-grain, United States service bullet, for example, should measure just about .30825 inch.

HOW TO MAKE A SULPHUR MOULD

It often happens that one wishes to measure the chamber of his rifle to determine its exact size and dimensions, and to determine how these compare with the measurements of the cartridge and bullet. The best method of doing this is to make a sulphur mould of the chamber, and then measure the mould with a pair of micrometer calipers reading to thousandths of an inch.

First, wipe the bore of the rifle, and the chamber as well, perfectly dry and clean, using gasoline and then dry patches. If any metal fouling is present, use the regular metal fouling solution. Then run through a patch saturated with kerosene until there is a thin coating of this oil covering all portions of the bore and chamber. Next, melt powdered sulphur in an iron dish with a lip of some kind from which a small, thin stream can be poured. This is best done over a gas flame or alcohol lamp. Have at hand a cover of some kind for the dish so that the flame can be smothered in case the sulphur catches fire. Put a tight wooden plug in the bore of the rifle just ahead of the chamber. Then pour the fluid sulphur into the chamber from the breech. As the sulphur cools a hole will form in the center. Keep on pouring slowly until this hole is filled up. Allow it to stand a short time to cool and solidify, then push it out carefully by means of a cleaning rod inserted from the muzzle. It may start rather hard at first, in which case try a few very light taps on the cleaning rod with a hammer, being careful not to hurt the mould. The mould will make a perfect cast of the chamber, and the shape and measurements of the chamber can be determined from it. A sulphur mould will not change for the first 48 hours after it is taken out, but after that you may expect it to shrink about .001 inch, and the surface will change until it has a rough appearance.

MUZZLE-WEAR

We have always believed that muzzle wear caused by the friction of the cleaning rod against the muzzle of the rifle when cleaning from the muzzle ruined the accuracy of the rifle. To determine the truth in this matter the following experiment was undertaken. The shooting was at 100 yards with muzzle and elbow rest. The groups were ten shots each. The rifle was a .30-40 Winchester single shot with a 30-inch, No. 3 round barrel. The groove diameter of the barrel was .3082 inches. The rifle was sighted with a Winchester A5 telescope sight. The mountings of this sight are such a distance apart that one minute on the mounting actually equals an adjustment of only half a minute of angle; that is, raising the elevation from 80 to 82 minutes with those mountings raises the point of impact 1 inch at 100 yards. This should be understood in order to comprehend the results.

Groups Nos. 1, 2, and 3 were fired with the muzzle in perfect, normal condition with three different makes of ammunition, all being the high-power ammunition with 220-grain, soft-point bullet. The size of these groups is given in the tabulation below, both the mean radius, and the diameter of the circle which will contain the center of all the shot holes (group measure) being given. The muzzle was then slightly deformed (worn), to approximate as nearly as possible long-continued muzzle wear with the cleaning rod. The enlargement was done with a very fine rat-tail file and afterwards smoothed off with a whetstone, the muzzle being enlarged unevenly so that at the bottom of the bore at the muzzle the enlargement was .006 inch measuring from the top of the lands, while at the top of the bore the enlargement was only .002 inch. Groups Nos. 4, 5, and 6 were then shot with identical conditions as to weather, rest, sight adjustment, point of aim, and ammunition. The ammunition used in Groups 1 and 4, 2 and 5, 3, and 6 were the same from the same box of 20 rounds purchased fresh from the factories for this purpose. In the tabulation elevation and windage readings have been corrected to bring the center of impact to the point of aim so that these readings will show the relative difference in points of impact, bearing in mind that one minute in the table is equal to half an inch at 100 yards as explained above.

MUZZLE WEAR TEST. GROUPS FIRED AT 100 YARDS

Group No.	Mean radius, inches	Group measure, inches	Elevation, $\frac{1}{2}$ minute	Windage, $\frac{1}{2}$ minute
1	.982	4.20	72.5	91. (a)
2	1.183	3.30	80.4	91. (b)
3	.852	3.80	83.	93. (c)
4	.630	2.82	83.	95.5
5	.620	1.75	80.5	94.5
6	.691	1.70	75.	94.
7	.486	1.33	84.	95.5

(a) 8 shots of this group measure 2.18 inches.

(b) 8 shots of this group measure 2.59 inches.

(c) 9 shots of this group measure 1.90 inches.

Groups shot from commercial rifles are almost always considerably enlarged by one, or usually two off shots as explained in the chapter on Accuracy.

Groups Nos. 1, 2, and 3 should be scanned carefully by those who use sights on their hunting rifles which are not adjustable for elevation. These were shot from a heavy No. 3 barrel, which is almost twice as thick as the barrels usually seen on repeating rifles. Notwithstanding this, if we take the first make of ammunition used in Group No. 1 as a standard, we will see that No. 2 make shot 4 inches lower at 100 yards, and No. 3 make 5.25 inches lower and 1 inch to the left. Moreover, although not shown in the tabulation, the first make of ammunition shot $1\frac{1}{4}$ inches higher on this day than what may be called its normal elevation.

It will be seen that after the muzzle of this rifle was deformed it grouped its shots on an average 1.33 inches to the left of where it grouped them before when the muzzle was perfect. With one make of ammunition it shot 5.25 inches lower after deforming than before. With the second lot of ammunition the elevation was practically the same after as before, and with the third lot the rifle shot its group 4 inches higher on the target after deformation than it did before. No attempt is made to explain these differences. The test was made with extreme care, the results checked up many times, and it can be relied on.

It will be noticed that the rifle shot smaller groups in every case after the muzzle was deformed than when it had a perfect muzzle. This is merely a coincidence and does not of itself prove anything except that *deforming the muzzle does not* destroy the accuracy of the rifle. It does, however, entirely change the normal sighting of the rifle. This is in line with the experiments of Dr. Mann, he having found practically the same thing. If the rifleman cleans his rifle from the muzzle, and does not take care that the cleaning rod does not rub

the muzzle in doing so, the muzzle will become worn very gradually, and the normal sighting will change gradually, necessitating a change in sight adjustment. The target shot can easily keep track of such changes, but the hunter who cleans his repeating rifle from the muzzle should occasionally target his rifle so as to keep track of the changes and have his arm always correctly sighted.

I want to call particular attention to Group No. 7 in the above tabulation. I had at the range on the day on which these experiments were

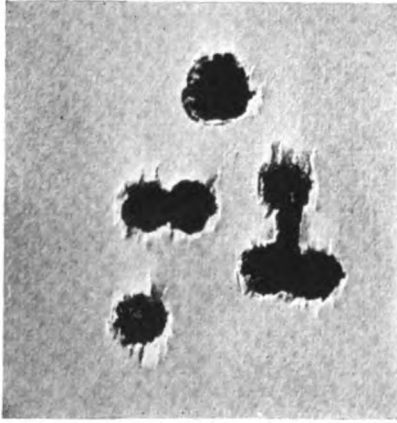

Fig. 110

Group No. 7. Ten shots at 100 yards, muzzle rest. .30-40 Winchester single-shot rifle. Telescope sight. Winchester 220-grain soft-point, factory ammunition. Fired from the rifle after the muzzle had been deformed. Group measures 1.33 inches. Mean absolute deviation .486 inch.

conducted a box of old Winchester, 220-grain, soft-point, factory ammunition that was purchased seven years before in a gun store in Philadelphia. Since then that box had travelled all over British Columbia on a pack horse, went to the Philippines and stayed there two years in the tropical heat and dampness, and came back and has been kicking around my workshop in various localities in the United States ever since. It occurred to me that it would be interesting to see what it would do, as the test would represent the accuracy that a hunter could expect from an old muzzle-worn rifle and the kind of ammunition he would probably get in some little backwood settlement store. The results were most surprising. The actual target is shown herewith full size (Fig. 110). It is certainly a triumph for the American

rifle and ammunition, especially when it is considered that the rifle it was made with is an ordinary stock model and cost the writer the sum of \$15 without sights. It will be noticed that in this test five of the shells on being fired split at the neck. This is almost always the case with very old ammunition where the bullet is not crimped in the shell, but is retained in the shell by originally having the shell considerably smaller than the bullet and then forcing the bullet in in loading, as was done with this particular ammunition in loading at that particular time. The brass at the neck is thus under considerable tension all the time, and after two or three years it gets "tired" and when some unusual strain comes it breaks. All government ammunition now has the bullet crimped into the shell instead of having it pressed into a much smaller shell to hold it tight and waterproof.

The rifle with which these tests were made has been in my possession since the spring of 1906. It has been fired many thousands of rounds with all kinds of ammunition. On account of its accuracy it has been one of the principal testing rifles, and many experiments have been conducted with it. The barrel is one of those that one gets by accident once in a lifetime. After all this use I can see no wear in the barrel at all, and the rifle is just as good as the day it was purchased. After this experiment the barrel was cut off to 27 inches and the muzzle trued up. If anything, shortening the barrel these three inches increased the accuracy.

PART II
PRACTICAL RIFLE SHOOTING

CHAPTER XXIII

THE A B C OF MARKSMANSHIP

RIFLE shooting is almost entirely a matter of *intelligent* practice. Practice alone, without head work, will not get one very far. To illustrate, take the case of the man who made the highest score in the course in rifle shooting of the 10,000 men attending the Plattsburg training camp of 1916. He was a man of about thirty years of age, and had never fired a rifle before in his life. He had only about four days of preliminary instruction, perhaps two hours a day, before going on the range, but he stated that he paid particular attention to the instructions of his officers, and tried to follow them as closely as possible. On the other hand, in my work in the Army I often come across men of a rather low order of intelligence whom no amount of practice will teach to shoot, chiefly because they have never learned how to use their brains. Any man of ordinary intelligence, who is not physically handicapped, can become a good shot. To become an expert shot requires both a good body and a good brain. Most persons have the idea that eyesight is the important factor. Fair eyesight is of course essential, and may be obtained either naturally or by the aid of well-fitted glasses.

There are five essentials which must be attained in order that one may be able to shoot accurately. All instruction in rifle shooting is aimed at perfecting one's knowledge and execution of these five essentials. These are as follows:

1. *Aiming.* One must be able to aim consistently, aiming each shot exactly the same. This requires the training of the eye in the correct alignment of the sights and target until the view or picture that they form becomes so indelibly impressed upon the retina of the eye that whenever the aim is the least bit incorrect it will be noticed at once.

2. *Holding.* One must be able to hold the rifle steadily in the various firing positions. First, a good, well-balanced position must be learned, and then this must be practiced until it becomes perfectly natural, and one acquires steadiness in it. Usually this takes longer to learn than the other essentials.

3. *Trigger squeeze.* It matters little how accurately one aims, and how steadily one holds, if, just as the rifle is discharged, one gives a convulsive jerk to the trigger which deranges both aim and hold. The trigger must be squeezed so that the rifle is not disturbed, does not move a particle, before the recoil comes.

4. *Calling the shot.* Literally calling to the coach the exact spot where one's sights were aligned on the target at the instant that the rifle went off. Of course one tries to hold steadily, but absolute steadiness is beyond the ability of most riflemen. The sights bob around a little with the best of us. We must catch with our eye the exact place on the target where the sights were aligned at the instant that the recoil blots out clear vision. This spot is where we expect the shot to strike. If the shot does not strike close to the point of call it shows that there is something the matter with either rifle, ammunition, or sight adjustment. If one has a good rifle and ammunition it indicates that a change in the sight adjustment is necessary.

5. *Sight adjustment.* The sights of the rifle must be adjusted so that the bullet will strike close to where one aims. Owing to factors which will be discussed later, almost all men require slightly different sight adjustment. Thus a rifle sighted in by one man is by no means correctly sighted for others, and rifles sighted in at the factory are never more than approximately correct. One must be able to adjust his sights so that the bullet will strike where his rifle is aimed; that is, where the shot was called.

Finally, one must learn to co-ordinate all these five essentials. He must learn to aim accurately, and at the same time hold the rifle steadily. While he is doing this he must be gradually increasing the pressure on the trigger, so that when the aim seems best, and the hold the steadiest, he can squeeze on the trigger the last ounce or so of pressure which will discharge the rifle. And while doing this he must not forget to catch the point where the sights were aligned at the instant that the rifle goes off. He must learn to concentrate his mind, and every bit of his will power on doing these four things, and doing them perfectly.

The secrets of good shooting are:

1. Know your rifle. Get a good rifle and stick to it. Do not be changing your rifle all the time. Never change to a new arm until you know the old one as perfectly as it is possible to know it. There is a very true saying, "Beware of the man with one rifle."

2. Pay the closest attention to every little detail.

3. Be careful. Lots of good scores are spoiled, and lots of game escapes, through carelessness alone.

4. Be accurate. You are handling an instrument of precision, but it will not avail you if you be not accurate yourself.

5. Don't get excited. An excited man cannot hold a rifle steadily, nor will his aim be accurate. Excitement usually comes from a lack of confidence; that is, from a lack of practice.

6. Go slow. Especially at first, go slow. Many men who have been shooting for years will never make really good shots because they do things so fast, or so impulsively, that they do not get the required steadiness or accuracy. Do not attempt rapid fire until you have mastered the slow fire. Skill in slow fire never makes a man a poor rapid-fire shot; it is lack of practice in rapid fire.

Some men soon acquire a remarkable ability to shoot the rifle, but it must be remembered that to be really expert one must have his lessons so drilled into him that even when excited he will still continue to shoot well. This means that one must practice until shooting becomes second nature before he can really call himself expert. In every case where anything important is at stake in rifle shooting there will be a certain amount of excitement, physical exertion, and necessity for speed. Let the novice not think that because he has made a score which equals the record he is an expert. Let him try to duplicate his work after a hard climb up a steep mountain when a mountain sheep suddenly leaps up and is about to disappear over a ledge. Or again, on the battlefield, when he must beat the other fellow to it with a perfectly placed bullet or go under. Most beginners can become good shots after several weeks of daily intelligent practice. To become a real expert requires years of practice, study, and experience. If it were not so the game would not be worth the candle.

CHAPTER XXIV

AIMING

BY aiming we mean the accurate pointing of the rifle at the bull's-eye, or at the game, or enemy we wish to hit. Aiming consists in getting the rear sight, the front sight, and the object we wish to hit all in the same line. It is a delicate operation, and requires lots of care and attention to the little details. With some men it is first necessary that the eye be educated to seeing finely and accurately. It is more like threading a needle than driving a nail.

At the start one should appreciate the necessity of care and accuracy in the alignment of the front and rear sights. Suppose these sights are placed 24 inches apart, then an error of $\frac{1}{160}$ inch in aligning them will cause a deviation in where the bullet strikes of 1 inch at 100 yards, 2 inches at 200 yards, 5 inches at 500 yards, and so on. It is only an eye well trained to see and appreciate small distances that can see an error as small as $\frac{1}{160}$ inch. The untrained man will hardly appreciate an error of twice this size, which would mean an error of four inches at 200 yards. The methods of aligning open and peep sights are slightly different and will be described separately.



Fig. 112

Alignment of open sights in aiming at a target



Fig. 113

Alignment of open rear, and ivory or gold bead front sight when aiming at game

The best form of open sight is one which has a "U" shaped notch. In bringing such sights into line the top of the front sight should appear in the middle of the "U," and also with its top surface just even with the top of the U notch, as shown in Figs. 111 and 112. Fig. 113 shows some of the more common errors of aligning, and the results which will ensue. A very common error is the drawing of the front sight down too fine in the notch. If the sights are adjusted

to strike center when the front sight is held at the standard height, this drawing fine will result in a low shot. If the rifleman, through a misconception, adjusts his sights so as to strike center when the front sight is drawn down fine in the notch, his shots will be apt to string up and down on the target, and he will get many misses under

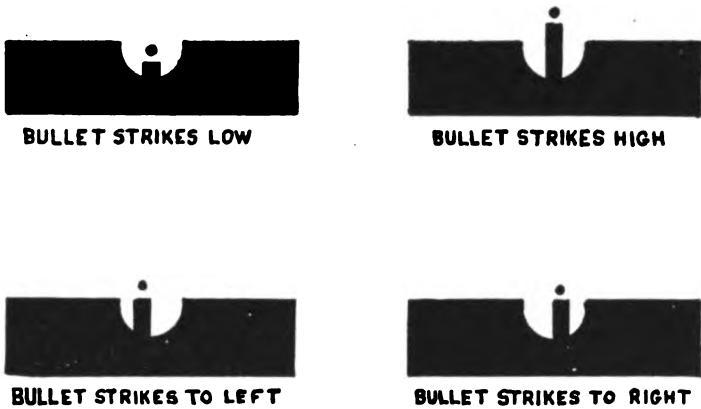

Fig. 113
Showing errors of aim, and the result

and over, particularly in changes of light. One can see very well to measure the correct amount of front sight seen in the notch by lining the top surface up with the top of the "U," but if he tries to draw fine it will always be merely an estimate as to whether he has drawn down fine enough, or too fine, or not fine enough. Estimation is just another word for guess-work.

With the peep sight one should see the top of the front sight in the center of the peep-hole or aperture. This is the only correct

method. An aperture always has more light at its center than near the edges, also an aperture acts as an orthoptic, and clears the vision of things seen through its center, making all seem in perfect focus. Then too, the human eye has a natural aptitude for centering objects, and if allowed to exercise this aptitude it can place the top of that front sight extremely accurately in the middle of the peep-hole. In learning to align peep sights too much time should not be devoted to practicing the perfect centering of the tip of the front sight in the center of the aperture, because it teaches a bad fault, that of paying too much attention to the peep sight. Many men complain that they cannot use the peep sight. This is entirely because they pay too

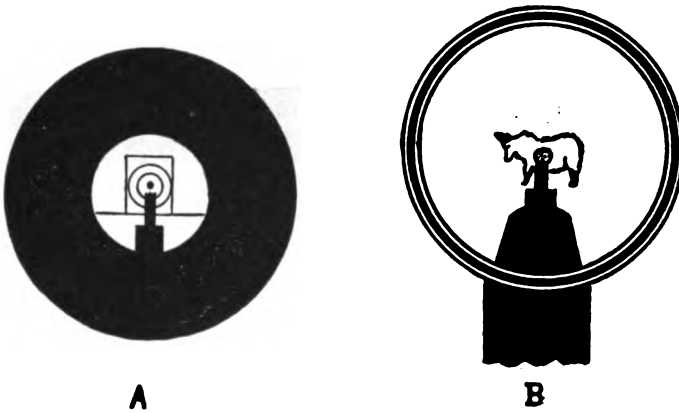

Fig. 114

Alignment of peep sights in aiming

A — Vernier target peep sight, or Lyman peep with detachable cup disc.
 B — Lyman peep sight aligned on game.

much attention to the peep sight; too much attention to centering. Do not look *at* the peep sight, look *through* it. Pay attention only to the front sight. Aim as though you were aiming a shotgun which had but one sight at the muzzle. The eye will soon learn to center the front sight in the peep, and will do it accurately and the same each time without burdening the mind with it. This method also gives better vision, as no attempt is made to focus on the rear sight. No matter how much the peep sight blurs it will still be accurate, as the eye will pick out the center of the blur. Fig. 114 shows the method of aligning peep sights.

In shooting at a bull's-eye target, with either open or peep sights, the line of aim should strike the target slightly below the bull's-eye.

That is to say, the top of the front sight should be held slightly below the bull's-eye so that a small strip of the white target is seen between the top of the front sight and the bottom of the bull's-eye. The reason for this is that both the front sight and bull's-eye are black, and if, in aiming, the front sight were allowed or made to touch the bull's-eye, or effort was made to aim at the center of the bull's-eye, the front sight and bull's-eye would blend, and at the distance one could not see whether the front sight was being held in line with the center, the top, or the bottom of the bull. Experience has shown that if one attempts to "touch" the bull's-eye with the front sight, the shots will string up and down on the target. So instead we aim slightly below the bull, and the sights are so adjusted that when aim is taken thus the rifle will shoot a trifle high, and the bullet will strike the center of the bull. In aligning the sights thus, care must be taken always to see the same amount of white target between the top of the front sight and the bottom of the bull's-eye. After a little bit one becomes accustomed to aiming thus, and can always take just about the same amount of white.

In shooting at game or at an enemy a slightly different alignment is advisable. In such cases it is best to hold the alignment just where it is desired the shot should strike. That is, hold the top of the front sight just touching the point you wish to strike. The sights are then so adjusted that the bullet hits the exact point of aim. Fig. 114-B shows the Lyman peep sight aligned on the shoulder of a goat.

These cuts should be studied carefully, and one should repeatedly aim the rifle from a rest until he becomes thoroughly accustomed to the appearance of correctly aligned sights. The object is so thoroughly to impress on the retina of the eye the "picture" of the sights and target correctly aligned that the memory of it will persist, and if, when one aims, there is any error present, that error will stand out and make itself at once manifest. Accurate aiming consists simply in being able to reproduce exactly the same each time the picture of the two sights and the target.

It is absolutely essential for accurate aiming that the eye be held steadily in the line of sight. If the eye "bobs" around in and out of the correct line, the sights and target can never be lined up perfectly. For this reason it is always necessary to press the cheek hard against the side of the butt-stock, just in rear of the comb, so that the eye is exactly in the line of sight. One soon learns the exact spot on the stock to press against, and can thus catch the aim very quickly.

Here is where a well-fitting stock pays for itself, placing the cheek and eye in exactly the correct position without any strain. Be careful not to crane the head over the stock, because the rise of the rifle in recoil would probably give one a severe thump in the face. If the cheek be tightly pressed against the side, the head moves back with the recoil, and moreover the cheek itself helps considerably in the steady holding of the rifle.

THE AIMING BAR

The aiming bar is a device used to teach the recruit the correct method of aligning the sights and target. It is very easily made, and

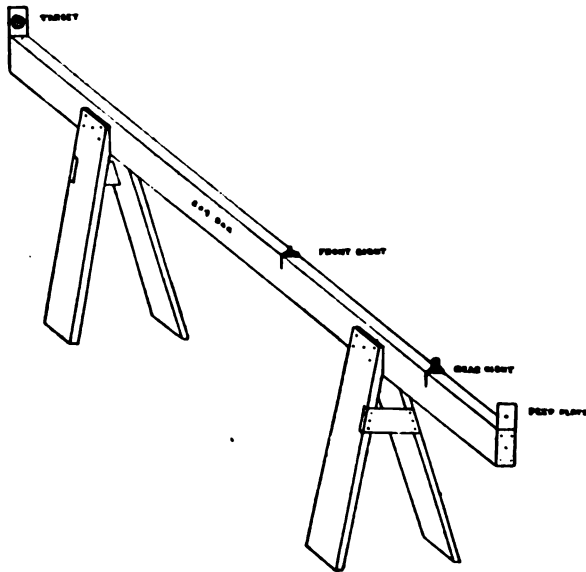

Fig. 115
Aiming bar

is quite useful in instructing the novice. Procure a "2 x 4"; that is, a piece of wood 2 inches by 4 inches by 10 to 14 feet long. Construct legs for this like a saw-horse, so that the upper surface (2-inch side) will be about 42 inches above the ground or floor, legs to come about 2 feet from the ends of the "2 x 4." Procure some sheet metal (tin, galvanized iron, or brass) and nail a small plate on either end of the bar, with a portion about 2 inches wide by 3 inches high extending above the bar as shown in Fig. 115. The plate at the end

of the bar towards the eye is to have a very small peep-hole drilled in its center; that is, in the center of the rectangular portion extending above the bar. This hole should be just a trifle larger than a pin hole. The plate at the other end has a small paper target pasted on it, so that the target faces inward, and can be seen when the eye is applied to the peep-hole on the other plate. Now make two transverse saw-cuts with a thin saw about 1-inch deep on the upper surface of the bar, the first cut to be the same distance in front of the peep-hole plate that the rear sight on the rifle normally is in front of the eye in aiming. The other saw-cut is located a distance in front of the first equal to the sight radius; that is, the distance between the front and rear sights on the rifle. Cut out of the sheet metal two pieces exactly like the sights of the rifle; that is, so that they will appear the same shape and size as the sights when viewed from the rear. Leave a broad base to each so that they can be inserted in the saw-cuts. Place these sights in the saw-cuts, lightly securing them with small wedges if necessary. Place the eye at the peep plate and look at the target. Move the sights in the saw-cuts until they and the target appear in perfect alignment, and practically duplicate the view as seen through the sights on a rifle when aiming. It will be noticed that the peep plate at the rear end of the bar keeps the eye in the correct line of sight, so that the sights and target can be seen only in perfect alignment. The bar is to be set up so that the eye-end projects over the top of a steady table. The recruit sits down in a chair drawn up to the table so that he faces the peep plate, closes his fists, and placing one on top of the other, rests his chin in the uppermost fist so that his eye comes close to the peep-hole. He then looks through the peep hole and sees the sights correctly aligned. The fists keep the eye steady in the correct position to see through the peep. The instructor points out to him the correct alignment, and keeps the recruit at it until he has impressed on the retina of his eye a memory of the picture of the sights and target as they should appear. Afterwards the instructor may move either or both of the sights slightly so as to show to the recruit the various errors of aim. This device is excellent for teaching men all the principles of aiming, as they can comprehend the salient features very readily, and it is impossible for them to see the sights aligned other than as the instructor wishes.

AN AIMING EXERCISE

Construct the sides only of a wood box about 12 inches wide, 16 inches long, and 9 inches high, as shown in Fig. 116. On top of either end cut notches as shown, so that the forearm and barrel of the rifle can be placed therein and lightly secured with wooden wedges. Box should be so made that when it is placed on top of a table the rifle will rest secure in it, and the barrel of the rifle will

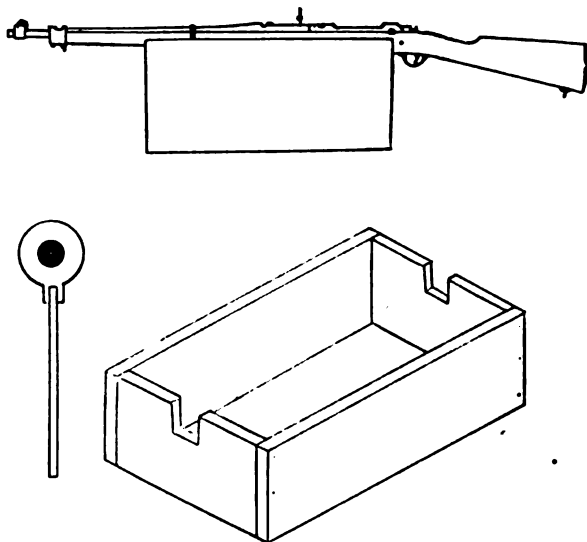

Fig. 116

Rifle rest box, and cardboard disc for aiming exercise

be approximately horizontal, with line of sight about 12 inches above the surface of the table. Set up a solid table with box and rifle on it at one end of a room. On the opposite wall of the room, in a well-lighted position, pin up a sheet of plain paper (wrapping paper) about 2 feet square, so that the rifle is sighted approximately near the center of the sheet. Provide a circular disc of white cardboard (see Fig. 116) about 3 inches in diameter, fastened on the end of a stick about 8 inches long. Paint a small bull's-eye in the center of the cardboard disc, and in the center of the bull's-eye make a pin hole.

The rifleman sits at the table behind the rifle, places his closed fists on the table, one on top of the other, chin resting in upper fist, so that

his eye comes in the line of sight of the rifle. The rifle must not be touched by the cheek or hands, or it will be thrown out of alignment. The fists assist in keeping the eye steadily in the line of sight.

The rifleman then looks through the sights of the rifle at the sheet of paper on the opposite wall. An assistant alongside the sheet holds the bull's-eye disc against the sheet so that it appears like a target against the sheet background. Aiming through the sights, the rifleman directs the assistant to raise, lower, move to the right or left, the bull's-eye disc until it appears absolutely correct in the line of sight, the rifle remaining immovable throughout the whole test. When everything appears correct, he orders the assistant to "mark it." The assistant, holding the bull's-eye disc steadily against the paper, inserts a pin or sharp pencil point through the small hole in the center of the bull's-eye, making a mark or dot on the sheet of paper, and then removes the disc from its position. This is repeated any desired number of times, the rifleman being careful not to disturb the rifle, and it results in a number of small dots on the sheet, or a "group" of dots. The dispersion of this group indicates the accuracy of aim.

The same sheet of paper may be used for a large number of trials, care being taken to move the rifle slightly between each series so that the group will not come in exactly the same place.

This exercise is in general use in the Army in teaching men to aim, and particularly to determine if, after preliminary explanation and instruction, they know how to aim, and if they take exactly the same aim each time. It may also be used to determine the accuracy of aim with a certain type of sight, or two rifles equipped with different types of sights may thus be tested for the purpose of determining the relative accuracy of aim with each type. If a standard distance between rifle and sheet of paper be established, the sheets containing groups can be kept as a record of the relative accuracy of a large number of sights of various types. By using a naturally painted picture of an animal in its native surroundings instead of the bull's-eye disc, and a pin hole through the animal's heart, one can determine the accuracy of aim, and the suitability of a certain sight in game shooting. In fact, this exercise has many possibilities connected with it.

NOTE. To obtain comparative results a distance of at least 30 feet is required between rifle and sheet of paper, as at less distances a good marksman, using almost any sight, should place almost all the dots in the same spot.

CHAPTER XXV

HOLDING AND THE FIRING POSITIONS

THE greatest difficulty that the novice will encounter at the start of his rifle practice will be the steady holding of his rifle. When he first attempts it, he will tremble and shake, the rifle will bob all around so that it will seem almost impossible to hold the line of sight on the target long enough to pull the trigger. The novice should not permit himself to become discouraged at the start. It should be remembered that whenever one performs an unfamiliar movement or exertion he will be unsteady and will tremble. The muscles are not educated or trained for that particular act, and the unaccustomed strain causes trouble and makes the nice co-ordination necessary for a finished movement impossible. The remedy is to practice the various positions until one becomes thoroughly accustomed to them, and until the muscles are trained and hardened for use in that particular manner.

Learning a good position is very necessary at the start. No one can hold steadily in an awkward, cramped position. Particular attention should be paid to the balance. For example, one can stand erect, feet slightly apart, body equally balanced, for a considerable time practically motionless. But let him lean a little forward so as to destroy the balance, and every muscle is put to a strain. In a few seconds he will begin to sway, shake, and tremble. Therefore in all positions one should take care to maintain a balance, and see that no muscle or portion of the body is under strain. Of course certain exertions, such as holding the rifle up to the shoulder, may be in the nature of a strain at first, but through practice soon become an exercise that can be easily performed.

There are four positions which are prescribed for military rifle shooting—the standing, sitting, kneeling, and prone. The sportsman will do most of his firing in the standing position, but occasionally will find it advantageous or necessary to assume one of the other positions. In these positions the rifle may be held, either without any artificial support, that is, “off-hand,” or it may be rested on some object, such as the crest of an intrenchment, a sand-bag, a log, a rock,

against a tree, or the side of a building. Advantage can always be taken of an object to rest the rifle on in combat firing, in warfare, and in hunting, but in competitive rifle shooting, and in the various military rifle practice courses, artificial rests are not permitted unless specially prescribed. The novice should always first learn to hold the rifle offhand, and we will therefore first consider these four prescribed positions with the rifle held without artificial support.

Attention is particularly invited to the illustrations of the various positions, which have been posed with great care. They show the positions exactly as they are assumed by practically every rifleman of prominence in the United States. This lesson of experience should not be disregarded. Imitate the positions as closely as you can. Pay attention to all the little details. Remember that it is by close attention to the little details, and by practice and headwork alone, that you will learn to excel with the rifle.

THE STANDING POSITION

This is a very important position to the sportsman as it is the position in which he will do 90 per cent. of his firing at game. It has fallen into disuse to a certain extent in military rifle shooting, but nevertheless it is important that it should be well learned by every soldier as it will be often necessary to use it in close-range firing, in brush fighting, in surprises, at night, in fighting in high grass, and in clearing out trenches. It is the position for quick work at short range, and for snap shooting. It is not a steady position for long range, and generally will not be used for shooting at ranges over 200 yards, nor when time permits a steadier position to be assumed. It is the hardest position of all to excel in, but a good rifleman should be able to hit his man, or a big game animal, every time at 200 yards when he is not unsteady from fatigue or recent exertion.

Face to the right at an angle of about 55 degrees from the target (see illustration), with the feet about 12 inches apart, weight of the body resting equally on each foot, body erect and well balanced. Raise the rifle to the aiming position, pointing it as nearly as possible at the target as you do so. As you place the rifle to the shoulder lean a very little backward, just enough to keep that nice balance which raising and extending the rifle out in front of you has momentarily destroyed. Do not lean forward at all as the trap shooter does, and do not lean back too much. Study the illustration. The butt of the rifle is as nearly in the hollow of the shoulder as the conformation of the rifle-



Fig. 117

Standing position, half-arm extension. The best standing position when rapid fire is necessary, and the correct offhand position for the sportsman

man will permit. With most men it will rest partly in the hollow of the shoulder and partly on the deltoid muscle of the right upper arm. Grasp the small of the stock firmly with the right hand, which should do more than two-thirds of the work of holding the rifle up and pressing it against the shoulder. Place the tip of the fore finger against the trigger so that the trigger rests in the first joint of the finger. The left hand grasps the forearm at a point from 10 to 14 inches in front of the trigger guard, depending upon the length of arms and breadth of shoulders. The forearm should rest well down in the palm of the left hand, not up on the fingers, and the fingers should be curled over the forearm, and should grasp firmly but without effort. The left elbow should be *almost under the rifle*, never way off to the left which is a very common fault. If the left elbow cannot easily be held almost

under the rifle it is usually a sign that one is facing too much towards the target, face a little bit more to the right. The left hand, grasping in this manner, is to do almost all of the steadying and directing of the rifle, and but very little of the supporting of it.

The right elbow should be raised so that the right upper arm is a little above the horizontal, and so that the head can be moved to the right to bring the eye into the line of sight, and the cheek will rest firmly, squarely, and comfortably against the left side of the butt-stock. The cheek presses against the stock, and assists quite a little in holding the rifle steady. By thus pressing the cheek to the right against the stock the right eye is forced into, and held steadily in the line of sight. Under no circumstances should the head be craned over the butt-stock to get the eye into the line of sight, as the rifle will jump up slightly when it recoils, and the nose or cheek will receive a severe blow. If the cheek be pressed against the stock as directed, the whole head, neck, and shoulders will move backward with the recoil, and the kick will not be felt.

Holding the rifle thus, take up all the creep in the trigger, and place on it as much finger pressure as you dare, but without discharging the rifle. Take a deep breath and let it out until the lungs are once more normal, get the eye and the two sights exactly in alignment, and holding them thus bring the alignment up on to the target, trying to hold it steadily just below the bull's-eye. Very few men will be able to hold the sights steadily below the bull's-eye, but the sights will seem to bob and wander all over the target. With considerable practice one gets to be able to restrict the wobble to the vicinity of the bull's-eye. Now watch carefully, and try to press the last final ounce on the trigger just as the front sight seems to pass under the bull's-eye in one of its gyrations. Receive the recoil by letting the whole body sway backward on the hips, and the recoil will not be felt. Do not exert yourself in trying to hold the butt hard against the shoulder to take the recoil. It should only be held snugly, as any undue effort will produce tremor. To avoid an unpleasant kick the novice should pay attention to pressing the cheek against the *side* of the stock, should keep his right thumb on the right side of the rifle, or on top of the tang so that it will not strike him in the mouth, should grasp the upper portion of the forearm firmly with the fingers of the left hand, and should be sure that the butt-plate is far enough in the hollow of the shoulder so that it will not slip out when the recoil comes.

In rapid fire in the standing position, do not take the butt of the

rifle from the shoulder between shots, but let go of the small of the stock with the right hand, holding the rifle hard against the shoulder and steadily in place with the left hand. With a bolt-action rifle, grasp the bolt handle with the right hand, and pull the bolt back hard and quick, moving the face slightly to the left to avoid contact with the bolt. Slam the bolt shut again, regrasp the small of the stock with the right hand, and release the hand pulling back with the left hand. At once take up the safety pull of the trigger with the right forefinger, and start the new aim. Do not be afraid to slam the bolt open and shut hard and fast. You cannot injure the bolt in this manner to save your life, and it makes the movement much quicker and surer, and insures against jams through failure completely to function the bolt.

To operate a lever-action rifle in rapid fire, proceed exactly the same as regards the left hand. The three last fingers of the right hand being inside the finger lever, let go the thumb grasp of the right thumb over the small of the stock, move the trigger finger a little forward in the trigger guard, and quickly throw down the lever to its fullest extent of travel. At once pull the lever smartly back against the grip, regrasp with the right thumb over the small of the stock, and start the pressure on the trigger with the forefinger, let up on the back pressure of the left hand, grasp hard and pull back with the right hand, and start the new aim.

The sportsman and the military rifleman should avoid the various standing positions with the left elbow against the side or hip, and with the rifle balanced on the finger tips, etc. These positions are designed solely for making big scores on the bull's-eye target in slow fire, as in Schuetzen contests. It is impossible to assume them quickly for snap shooting, or to use them for rapid magazine fire. They are of no use in the field, and have no place in either practical or military rifle shooting. The position described may be called the "hunter's position," and is the only one suitable for quick work and for moving objects.

THE SITTING POSITION

This is a very steady position, and an excellent one for rapid fire, and for shooting down hill. It is quickly assumed, and where one is not called upon for a very quick snap shot it would be well to assume it wherever possible, that is where vegetation, etc., does not prohibit, and where the ground does not slope upward.

Sit down, facing to the right at an angle of about 35 degrees from the target. The left heel should be so placed that the left knee and

thigh almost face the target, and the right heel so that when the left elbow is placed on the left knee the right knee comes in the correct place to rest the right elbow on easily. Both heels should rest in small holes in the ground, or against some slight irregularity on the ground,



Fig. 118

The standard sitting position. There should be slight holes in the ground in which to rest the heels

so that not only will they not slip, but will not have any feeling that they might possibly slip. The heels must *feel* secure, or the position will not be very steady. A little practice will show one just how far the heels should be extended to the front, and how much the knees should be bent. The right knee should be slightly higher than the left.

In aiming, first adjust the gun-sling, and use it as described under the prone position. It is a great help to steady holding. The elbows must be placed on the knees, and if the knees are not in just the right

position for this it shows that something is wrong with the position. If the point of the elbow be allowed to extend about an inch beyond the knee cap, a position will usually be found in which the elbow seems to stick naturally tight to the knee.

To aim a little to the right or left, shift the buttocks on the ground; to aim higher draw the feet in, thus raising the knees.



Fig. 119

Sitting position, legs crossed. A good position when the buttocks can be placed in a slight depression, getting the feet a trifle higher than the buttocks.

A similar position may be assumed with the legs crossed just above the ankles. This will be found advantageous if secure holes cannot be found or made for the heels. Also the legs may be crossed and the legs separated, each calf resting on the inside of the opposite foot, tailor fashion. This latter position is very steady, but it is hard for most men to assume it unless the ground slopes upward slightly, or

unless one can find a slight hole or depression to sit in, thus elevating the feet slightly above the buttocks, and raising the knees. If ground suitable for this variation of the sitting position can be obtained, it is almost as steady as the prone position.

THE KNEELING POSITION

This position can be very quickly assumed, and it can often be used with advantage as it is steadier than the standing position, and in a



Fig. 120
The standard kneeling position

majority of cases it raises the rifle to the height necessary to see over tall grass or inequalities in the ground. Whether the rifleman can assume it successfully enough to be able to do good work in it depends upon whether or not his right knee is limber enough to permit him to sit comfortably on the right heel. As a rule I do not favor this posi-

tion very much as it is not as steady as the sitting position, and only slightly steadier than the standing position. Often, and particularly in a stiff breeze, it is very difficult to control a slight horizontal swaying of the rifle.

Half face to the right, carry the right toe about a foot to the left rear of the left heel, kneel on the right knee, sitting back on the right heel. Adjust the gun-sling for firing as explained for the prone position. Aim with the left elbow resting on the point of the left knee, the point of the elbow a little beyond the knee cap, and the knee pointing towards the target. Hold the right elbow a little farther to the front than in the other positions. Be sure that the butt of the rifle is well into the hollow of the shoulder, as there is a tendency to hold it too far out on the right upper arm in this position. Holding the butt out on the upper arm not only makes one crane the head over the stock in aiming, thus increasing the probability of a blow on the mouth or nose in recoil, but also the recoil is apt to turn one half-way around, and make rapid firing difficult or slow. Study the illustration of this position very carefully. (See Fig. 120.)

The instep of the right foot may be rested flat on the ground, the buttocks coming on the lower part of the heel; or by resting the right side of the foot on the ground, toe pointing to the front, one may sit very steadily on the left side of the right foot. These positions can be assumed only by very limber men, but they make the position quite a little steadier.

Remember to lean well forward, and always to rest the left elbow on the knee, as unless this elbow is so rested the position is no steadier than the standing position.

THE PRONE POSITION

This is the most important of all the positions to the military rifleman, and it should also be completely mastered by the sportsman, as it is the steadiest of all the offhand positions. It is the position in which all the long-range world's records have been made. It is also the easiest position for one to learn to excel in, as any one with good physique can, under a skilled instructor, learn to hold his rifle practically immobile in a very few days. Yet, like all other positions, it takes practice to learn it, particularly so because the posture is so strange, and it is intensely uncomfortable when first assumed. But unlike the other positions it does not differ in the slightest with the conformation of the man. There is but one way to assume it. *One cannot depart from*

the standard position in the slightest without sacrificing steadiness. The position must be carefully studied by the novice, and all the little details perfected, as every one of them are essential. The use of the gun-sling exactly as described is absolutely necessary, and the details of its adjustment and use are therefore gone into as a part of this position. The three illustrations herewith, illustrating the prone position, should be studied most carefully.

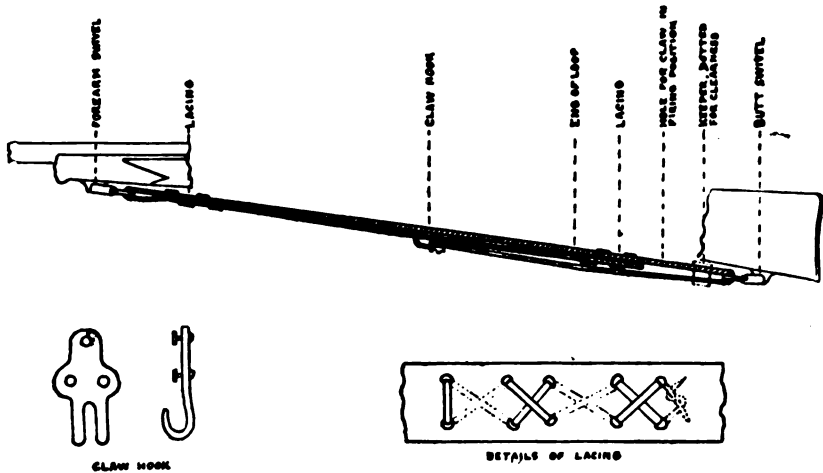

Fig. 121

Gun-sling for sporting rifle — Whelen pattern. The swivels are the type used for the butt swivel on the Winchester Model 1895 musket

We shall be obliged to digress here a little and describe the gun-sling. The military gun-sling on the Model 1903 rifle is constructed with a view to its use for both carrying the rifle, and as an aid to steady holding. All gun-slings should be modelled on about the same plan. Those usually seen on sporting rifles are absolutely worthless for anything except slinging the rifle over the shoulder, and not very good for that. Some years ago I designed a gun-sling for sporting use, which is illustrated in Fig. 121. The cut rather fully describes it. It has the loop for firing, which is intended to be adjusted to fit the owner of the rifle, and a tail piece to lengthen out for either firing or carrying the rifle. It has swivels which do not turn and get the sling tangled up all the time, neither do they rattle in the presence of game, as almost all sporting rifle gun-slings do.

The sporting rifle manufacturers almost invariably place the swivels incorrectly. The front swivel should be placed out well towards the

end of the forearm, not near its center. On a tubular magazine repeater, like the Winchester, the front swivel can be attached to the metal forearm tip. The butt swivel should be placed on the under side of the butt stock, about $2\frac{1}{2}$ inches from the toe of the butt-plate, not half-way between the toe and the guard as is usually done.

The following is the proper method of adjusting the military gun-sling as provided for the Model 1903 rifle, and also sufficiently de-

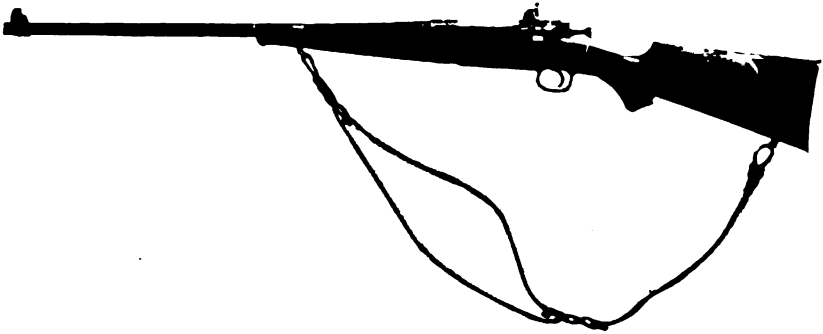

Fig. 122

Springfield sporting rifle with Whelen gun-sling adjusted for firing

scribes the adjustment of my own model sling. The two principal parts of the gun-sling are the long strap, which forms the loop; and the short strap, which extends from the end of the loop down through the butt swivel, and back under the barrel, hooking into the long strap. For military drill and ordinary carrying, the short strap is kept hooked up tight, so that the entire sling is taut between the two sling swivels. When thus adjusted the long strap should be hooked up so that a loop is formed which extends from the lower band swivel (forearm swivel) down to a point opposite or immediately under the comb of the stock; that is, the loop, when pulled tight under and parallel to the stock, should extend as far back as the comb of the stock. This is the right length loop for the average man with the Model 1903 rifle. (With sporting rifles this measurement will not always be correct, and the sling should be tested in the prone position for correct length of loop.) Stout men, or those having very short arms, need a loop adjustment an inch or two longer than this. It is a mistake to have the loop too long, as the pressure which holds the rifle steady cannot be exerted with a long, loose sling. The sling is to be habitually kept hooked up taut, with the loop adjusted to this length, except for firing, and when it is desired to sling the rifle over the shoulder.

To adjust the gun-sling for firing, unhook the short strap from the long strap, and stretch the sling out without altering the length of the loop (which should never be changed), and hook up the short strap



Fig. 123
Placing the sling on the arm

on itself, placing the teeth of the hook through one of the pair of holes about 6 inches below the metal loop which connects the long and short straps. When the sling is adjusted to the arm, and the firing position assumed, the short strap should always be loose, without any tension. Tension here will cause the rifle to be canted, and the position to be unsteady.

The loop of the sling is to be adjusted to the left upper arm above

the swelling of the triceps muscle; that is, about an inch under the arm-pit. To keep the sling this high up on the arm it is sometimes necessary to sew a short piece of quarter-inch rope on the inside of the sleeve of the shirt or shooting blouse so as to form a ridge which will keep the sling from slipping down. Under no circumstances should the sling be allowed to slip down to a point just above the elbow. This is a very common fault seen among beginners. In fact, among the expert shots at the national matches it is always taken as the sign of the beginner. The sling must be kept high up on the upper arm if the best results are to be derived from its use.

It is best to place the sling on the left arm before lying down. With the rifle pointing to the front, barrel up, carry the left hand from the left of the rifle through between the rifle and the entire sling, and then back again through the loop (see Fig. 123); slip the loop high up around the left arm, and pull down one of the sling keepers to retain the loop in place on the arm. By placing the arm through the loop in this manner, when the firing position is assumed the flat of the strap, and not the edge, will bear against the left wrist.

Now we come to the assuming of the prone position. Standing on the ground from which one is to fire, select a smooth, level place on which to lie, and estimate the spot where the right elbow will come when lying down. Place the heel of the boot on this spot and spin around several times on the heel, thus making a hole in the ground about an inch deep and three inches in diameter. This hole is for the right elbow to rest in when aiming. A hole is not absolutely necessary, but it adds to the security of the position, and is a help in rapid fire as it does away with any tendency of the right elbow to slip outward. A small hole for the left elbow also will help, but these holes must be in exactly the right place, or they are of more harm than good. The position must determine where the holes are to come, not the holes the position.

Almost every novice makes the mistake of lying down facing the target. This is absolutely wrong, as also is facing only a little to the right. *One should face a full 60 degrees to the right of the target when lying down*, and should spread the legs wide apart so as to permit the entire abdomen to rest flat on the ground (see Figs. 127 and 128). With the sling around the left upper arm, carry the left hand up on the left side of the sling, and then grasp the forearm just in rear of the forearm sling swivel. The knuckle of the left forefinger should almost touch the lower band swivel (except for men with very

short arms who will have to grasp the forearm farther to the rear). In this position the sling, starting from the forearm swivel, passes to the right of the left wrist, and then around the left upper arm. That portion of the sling between the loop and the butt swivel is loose.

Place the left elbow in the hole in the ground made for it. Raise



Fig. 124

The prone position. Getting into position with tight gun-sling

the butt of the rifle to the shoulder and assume the firing position. Right here probably most men will find it impossible to get the butt up to the shoulder—the sling seems too tight. *Do not loosen the sling.* Raise the right shoulder and roll over slightly on the left side. Now the butt can be shoved into the hollow of the shoulder with the right hand (see Fig. 124). Then roll back into the firing position, and the rifle will be found to be clamped in position pointing at the target. Please notice that this position will probably be intensely uncomfortable to the recruit at first. He can hardly bear it for more than 15 or 20 seconds at a time. It seems particularly to strain the left wrist. It must be persisted in, however, and not changed in the slightest. Three or four days' practice, half an hour a day, will overcome this, and after the first week one will be able to lie comfortably for long enough to fire 20 or more shots, slow fire. It is astonishing how soon

one becomes accustomed to what seems at first an intensely uncomfortable, unnatural position, and how naturally the old hand assumes this position.

Now let us examine this firing position in detail. Pay particular attention, because all this is very important. The left elbow should be



Fig. 125

The prone position, right side, showing the correct method of using the gun-sling almost directly under the rifle. A perpendicular dropped from the left side of the forearm should strike the right side of the left elbow. The sling, starting from the forearm swivel, should pass to the right of the left wrist, and then around the upper portion of the left upper arm as before described. The loop should have about 50 pounds tension placed on it by the left arm, and this tension should be as nearly equal for every shot as the rifleman can make it. The short strap should be loose without any tension on it. The forearm should rest well down in the palm of the left hand. Spread the fingers straight out, flattening the palm, and let the rifle rest on the flattened palm alone, moving the palm a little to one side or the other until the rear sight stands up straight without any cant or lean to the rifle. Now close the thumb and forefingers firmly over the top edge of the forearm, but so that they will not interfere with the line of sight. This

is the proper hold for the left hand. If the rifle be held off the palm of the left hand, and be supported by the fingers, each joint and muscle of each finger will tremble slightly, and the position will be unsteady; so too, if some muscle has to be constantly at work to overcome a tendency to cant. The theory of this position is that the rifle is supported by the bones of the forearm, which are bound to the rifle and



Fig. 126

Prone position, showing manner of using the gun-sling. View from left side

to the ground by the sling and the weight of the body. There is thus one solid, firm support, and the muscles and joints, with all their tremors, are eliminated entirely.

The right elbow should rest firmly on the ground, and if one has time a hole should be dug for it, but this hole must be in just the right place. Regard the two upper arms and the front of the chest as the three legs of a tripod. If these legs are too far apart, or too close together, the tripod will be unsteady. There is just one position for them. As a rule the novice has a tendency to spread the elbows too far apart, and to hug the ground too closely. The right hand grasps the small of the stock only lightly, right thumb on top of, and a little to the left of the upper tang, right forefinger on the trigger, other fin-

gers grasping the small of the stock a little farther to the rear than in the other positions. Press the right cheek hard against the left side of the butt-stock, head a little farther forward than in the other firing positions. Don't worry about receiver sights or cocking pieces striking



Fig. 127

The prone position from above, showing the angle at which to lie, and the position of the legs

the eye, because when the rifle recoils it is only going to come back about an inch if it is correctly held, but if the rifle is equipped with a peep sight on the tang one must be careful to keep the eye at least 2 inches from it or there is liability of the eye being struck by the sight. The butt rests where the tendon of the pectoralis major and the deltoid muscle seem to join, which is a little below and to the right of the true hollow of the shoulder. The novice should be very careful to get this position exactly correct the first few days he practices it. Work at

first for accuracy of position only. It is not nearly as complicated as it sounds on paper, but a good coach is a great help in getting it correct.

Now for the advantages of this position. If it is assumed exactly as prescribed, and is practiced for half an hour a day for a week, pay-

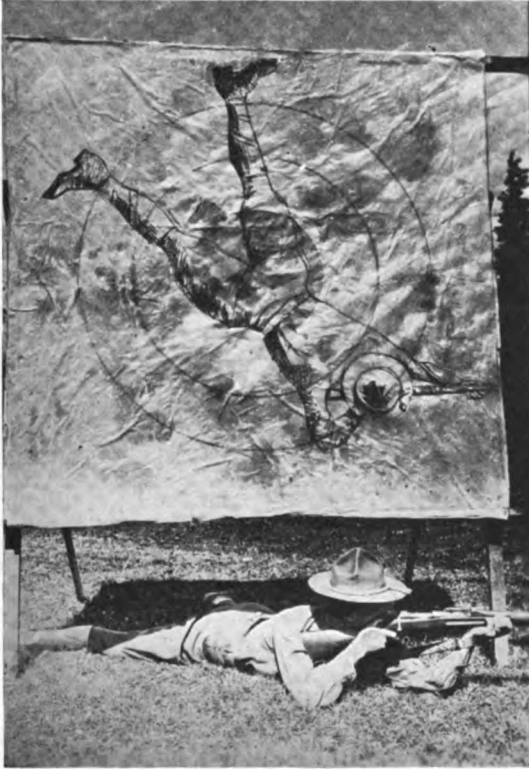

Fig. 128

The prone position, showing method of using the gun-sling. Sketch on target above shows the angle at which to lie in relation to the line of fire

ing particular attention to all the little details as here described, at the end of that time one will find that he can place the sights of the rifle on the target and hold them there steadily, sights aligned just below the bull's-eye, exactly as though the rifle were in a vise. There will be no visible tremor to the rifle. Think what this means? It means good shooting and big scores. Also it will be found that the tight hold takes up all the recoil. The recoil is not felt by the shoulder at all, but is apparently distributed all over the body. As far as the recoil

is concerned one can fire a hundred shots in this position without the shoulder feeling it. Moreover, if one is shaky, either from recent exertion or from nervousness, it apparently makes little difference, as the tight hold prevents all trembling. In other words, the novice who learns this position suddenly finds that he can hold in it as steadily as the old seasoned shot.

In rapid fire in the prone position, with a bolt-action rifle, keep both elbows on the ground all the time. If possible, be sure to have a deep hole for the right elbow to rest in, as it helps a lot. Keeping the right elbow in this hole, as soon as a shot is fired, reach forward with the right hand and grasp the bolt handle; jerk the bolt handle up, and pull it hard and smartly to the rear; as the bolt comes to the rear, at the same time force the left hand over to the right and low, keeping both elbows in their position on the ground, or in their holes all the time. When the bolt is fully drawn to the rear the muzzle of the rifle should be 'way over to the right, and almost touching the ground. Close the bolt quickly, smartly, and with force, and at the same time bring the left hand up and to the left, raising the muzzle of the rifle so that it again points at the target. A little practice at this will enable one to do it with astonishing rapidity, the sights coming back on to the target so that very little rectification of the aim for succeeding shots is necessary. Firing in this manner with military rifle I have often been able to make six hits in 12 seconds on the silhouette of a man lying prone at 200 yards.

GENERAL RULES FOR ALL POSITIONS

Before starting to hold, take a deep breath, then exhale this breath, and let the lungs become normal before starting to aim and hold. The breath must of course be held while the aim and hold are being perfected, and one can hold the breath with very much less effort if a deep breath be taken just before.

Press the cheek hard against the left side of the butt-stock. The cheek assists almost as much in holding as either of the hands.

Do not lean the face, nose, or mouth over the stock in rear of the comb, and keep the thumb away from the left side of the small of the stock. If you violate this rule a bloody nose or cut mouth may result with a rifle of heavy recoil, while if you pay attention to it, and press the cheek hard against the stock, not trying to resist the recoil, but letting the body yield and sway with it, the recoil will never bother you in the slightest.

Do not cant the rifle. Keep it plumb. If you lean it to one side or the other the bullet will strike in the direction of the lean or cant.

Let the forearm of the rifle rest well down in the palm of the left hand. Remember that the muscles and joints are what tremble, and the fewer of them involved in any position the steadier will that posi-



Fig. 129

Prone position with sandbag rest, showing normal position, and the use of the gun-sling. Only the back of the left hand rests on the sandbag

tion be. Count the joints and muscles in the thumb and fingers of your left hand.

Keep the left elbow well under the rifle. If you want to support anything you place the prop straight under it, not at an angle.

Remember to keep your balance. Do not lean way forward, or way back, or your body will tremble and sway.

CHAPTER XXVI

TRIGGER PULL

IT matters not how carefully the aim is taken, or how steadily the rifle is held, if, at the instant of discharging the rifle, the aim and hold are deranged by the convulsive jerk at the trigger. The trigger must release the sear from the sear notch without the least movement of the rifle, or the bullet will not fly true to the point at which it was aimed the instant before the trigger was pulled. As one concentrates his whole will power on holding steadily and aiming accurately, the body becomes immovable, frozen, as it were. It is then quite difficult to transfer the will power to the trigger finger, and to press it so as to discharge the rifle, because the finger will be found to be "frozen" also. The tendency with the untrained men is instantly to relax on the hold and aim, and give a jerk or tug at the trigger. The tendency to do this must be constantly repressed. The matter of learning how to pull the trigger without aiming and holding at the same time is a very simple matter, but the co-ordinating of the trigger pull with the aim and hold so as to insure a perfect let-off, and at the same time maintaining the aim and hold to the very end, is a matter which requires considerable practice. In fact, an expert rifleman realizes that he must keep at practicing this all the time if he would maintain his ability to shoot accurately.

We find on American rifles three kinds of trigger pulls. First there is the old-fashioned, "clean" pull seen on the best single-shot rifles, and on the Winchester repeating rifles. When the trigger is pressed it appears to be immovable until the required amount of pressure has been applied to cause the hammer to fall. Then it gives away all at once, something like the breaking of a small glass rod. This is the best type of trigger pull. With it one soon learns how much pressure he may place on the trigger without danger of firing the rifle. That is, he learns to place all but an ounce or so of the necessary pressure to discharge the piece on the trigger as soon as he starts to aim and hold. Then, just as the aim seems the most accurate, and the hold the steadiest, he very carefully squeezes on this last ounce or so of pressure which discharges the rifle without any movement of the piece. Trig-

gers of this type when they come from the manufacturers pull off on an applied pressure of from five to seven pounds. This is entirely too heavy for accurate work. However, they are capable of being eased up to about 3 pounds, which is the correct weight for all-around rifle shooting. See Chapter XXII for instructions regarding the adjusting of trigger pulls.

Triggers of the bolt-action type are slightly different. When cor-



Fig. 130

Prone position with sandbag rest, showing the "razor strop" method of holding the gun-sling. A good position for deliberate slow fire, but not satisfactory for rapid fire

rectly adjusted there is a safety or preliminary pull, during which the trigger moves back about $\frac{1}{8}$ inch against the tension of the sear spring. This safety pull is absolutely necessary for the safety of the rifle, preventing premature discharge, and should never be eliminated. As a rule it takes about one and one-half pounds pressure on the trigger to take it up. After it has been taken up, and the trigger has moved slightly to the rear, the remainder of the pull is clean, as in the case just described, and the trigger pulls off with a total pressure of about $3\frac{1}{2}$ pounds. In pulling a trigger of this kind one must be careful to at once take up the safety pull as soon as the rifle is placed to the shoulder. That is, learn to place enough pressure on the trigger as soon as the finger touches it, to make it move slightly to the rear against the pres-

sure of the sear spring, and then start the *trigger pull proper*, as in the first case. One can soon become accustomed to a trigger of this kind, but it never satisfies one as well as the straight, clean pull, especially in rapid fire. With recruits in the Army it has been found that the larger percentage of failures to make good scores in rapid fire is due to not taking up the safety pull at all, but when the aim seems right, pulling the trigger the whole way back with one motion or jerk. This must be specially guarded against.



Fig. 131
Firing from a prone trench

The third type of trigger pull is that usually seen on self-loading rifles, and the modern type of hammerless repeating rifles. The trigger moves back quite a little before the rifle is finally discharged, but too often this movement is attended with a rough "drag," consisting of a series of jumps and catches, so that one can scarcely ever tell when he has applied the right amount of pressure. Moreover, the number of little jumps and catches to this preliminary movement of the trigger will differ according to whether the taking up movement is made fast or slow, so that one can never learn whether he has surely taken them all up or not. The consequence is that one never dares place as much preliminary pressure on such a trigger as with the first two types, and more pressure must remain to be squeezed on when the aim and hold are perfected. This leaves a larger chance for a jerk and derangement at the vital instant of discharge. Also such a trigger is liable to produce flinching, as a decided jump to the trigger when pressure is applied under high concentration of will power is liable to make one jump. First-class accuracy of shooting can never be attained with such a

trigger, and this is just one reason more why such weapons are only fit for short-range work.

One is not a finished marksman until this detail of trigger pull is learned so well that it is done instinctively and correctly, even in rapid fire or under excitement. Jerking the trigger and flinching can only be cured by learning to concentrate absolutely every atom of will power on holding, aiming, and trigger pull, so that there is no room in the brain or nervous system to permit of the forming of the act of jerking or flinching. It is all a matter of practice and concentration.



Fig. 132
Firing from a standing trench

CHAPTER XXVII

CALLING THE SHOT

VERY few men indeed can hold with absolute steadiness except in the prone position. There will be a certain tremor, and the sights, instead of resting steadily just under the bull's-eye, will seem to travel around over the face of the target as one aims. The rifleman endeavors to pull the trigger just as the sights drift under the bull's-eye. The measure of success which he attains in this depends upon his skill. Therefore the sights are not always absolutely correctly aligned on the target as shown in the plates illustrating the method of aligning sights and target.

Now it is obvious that the bullet should strike at, or close to, the point on the target at which the sights were aligned at the instant of discharge. If the bullet does this it is a sign that the rifle is correctly sighted for the individual who is using it. If, after several trials, it is found that the bullet does not strike close to where the sights are aligned at the instant of discharge, but on the other hand strikes some distance off in a certain direction, then it is evident that the sights require adjustment. A rifle should shoot where it is aimed, or, to put it in the language of an old mountaineer, "she should shoot where she looks."

In order to be able to adjust our sights to make the rifle hit close to where it is aimed it is evident that we must know where the sights were aligned at the instant that the rifle was discharged. To know this we must catch with our eye the exact spot on the target where the aim is at the instant before the recoil of the rifle blots out a clear vision of the sights and target. This catching of the aim at this instant is what is termed "calling the shot." The term comes from the practice in team shooting. The coach sat alongside of the pair of riflemen at the firing point, and advised them as to their shooting. As each man fired he "called his shot" to the coach; that is, he told the coach just where he expected his shot to strike before it was marked.

Calling the shot is not hard to learn. One has simply to keep his mind on it, to watch the line of sight as it trembles, and travels over the surface of the target, and to catch with the eye and retain the memory

of the last spot where he saw his sights pointed just before the rifle went off. Thus in Fig. 134 the sights were aligned high and to the right, and the bullet should strike the target near to this spot. Of course the bullet will scarcely ever strike the exact spot called, because no rifle is absolutely accurate, nor can one see with absolute accuracy at a great distance. But one should be able to call his shots within about 4 inches at 200 yards, 10 inches at 500 yards, or 20 inches at 1000 yards.

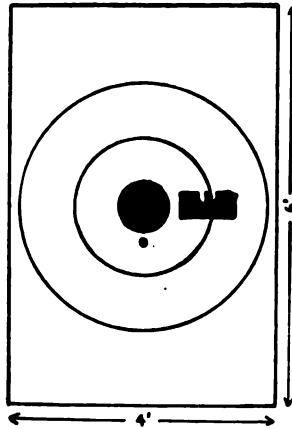

Fig. 134

CHAPTER XXVIII

SIGHT ADJUSTMENT

ONE cannot do accurate shooting unless his sights are correctly set. Therefore the matter of sight adjustment is one of the essentials to good shooting. The rear sight must be so adjusted for target practice that if one aims just below the bull's-eye as directed in the chapter on aiming, his shot will strike near the center of the bull's-eye. Military rifles have engraved on the sight leaf the position that the leaf should be placed in for every hundred yards of range. Sporting rifles have the sights approximately set for a certain distance, usually 50 or 200 yards, when the sight is at its lowest elevation. An untried rifle cannot always be relied upon to shoot into the bull's-eye with the sights set at the exact range. For example, on a calm day at 500 yards, one cannot always take a new rifle, and set the sights at 500 yards elevation, and at zero for wind, and be sure that a correctly aimed and pulled shot will strike the bull's-eye. Indeed the bullet may hit the target two or three feet off in any direction from the bull. Often the manufacturer tries to set the sights correctly for elevation and zero before they leave the shop. In many factories and arsenals a large number of skilled marksmen are employed on this work. But it must be remembered that these rifles are tested and the sights set under a certain condition only, and there are a great many things which influence the shooting of the rifle and the flight of the bullet, and hence make a change in sight setting necessary. Little differences in ammunition, wind, light, temperature, humidity, altitude, condition of the bore, and individual methods of aiming and holding all have their influence on the sighting necessary for a certain rifle. Moreover, owing to individual peculiarities of aiming and holding, two men, both good shots, may have to set the sights of the same rifle quite differently for both elevation and windage in order that their shots may strike where they aim them.

In Part I of this work stress has been laid upon the necessity of having the rifle equipped with sights which are readily adjustable for both elevation and windage, and which have positive readings by means of scales so that the exact adjustment can be read and recorded. It

is not possible to do good shooting, except at short ranges, unless such sights are used. Non-adjustable sights may be all right for a particular lot of ammunition, and a particular condition of the weather. But let one change his ammunition, or let the weather change considerably, and the rifle no longer shoots where it is aimed. A change of sight adjust-



Fig. 133
Firing around a building or tree — standing

ment becomes necessary, and the only way to get it with crude, non-adjustable sights is to alter their attachment to the barrel, or to file or alter them in some way. A continuation of this is, of course, impossible. Therefore we will here take it for granted that one has his rifle equipped with a satisfactory rear sight like those on our military rifles, or the Lyman Nos. 48 and 103 rear sights, or other similar rear sights having positive adjustments for both elevation and windage, as well as proper scales for reading and recording.

Suppose we are shooting our rifle for the first time at a certain range. For the sake of simplicity we will say that the range is 200 yards, because that is usually the shortest range that the modern military and high-power rifle is sighted for. If we are using a military rifle we set the sights at the 200-yard mark for the first shot, and if we are using a sporting rifle we place the sights as low as they will go for the first shot, taking it for granted that this is approximately the correct setting for 200-yards range. Our object is to get the sights so adjusted that the bullet will strike close to where it is aimed on the target 200 yards away. Let us say that we fire the first shot, and just the instant before the rifle goes off we notice that the sights were aligned, not just under the bull's-eye as we would like to have them, but at about a foot off the bull's-eye at 2 o'clock.¹ Fig. 134 shows the sights aligned on the target as they were the instant before discharge. It is evident, therefore, that we should expect the shot to strike the target a few inches above the point where the shot was thus called. But when the shot is marked we see that it has struck just below the bull's-eye, or at 6 o'clock, as indicated by the small round mark just below the bull's-eye on the target in Fig. 134. In other words, our shot has struck about 12 inches below, and 12 inches to the left of the spot where we called it. (We estimate this distance of 12 inches each way from our knowledge that the target is 4 feet wide and 6 feet high, and the bull's-eye is 8 inches in diameter.) Let us try just one more shot to be sure before we start to adjust the sights. This time we get our shot off just right with the front sight just under the bull's-eye, and were our rifle correctly sighted we would expect a bull's-eye. But when the target is marked we see that our shot has struck about eight inches out from the edge of the bull's-eye at 7:30 o'clock. Again it seems that the rifle is shooting about 12 inches to the left, and 12 inches low from where it is aimed. Our problem is, therefore, so to move or adjust our sights as to make the rifle shoot where it is aimed. That is, we must raise our elevation to cause the shot to strike higher, and we must move the wind gauge to the right to cause the shot to strike farther to the right. Right here we come across the most important rule of sight adjustment which every rifleman should remember. MOVE YOUR REAR SIGHT IN THE DIRECTION IN WHICH YOU WISH YOUR SHOT TO STRIKE. That is, if you want your shot to strike higher,

¹ For convenience in describing the location of hits on a target the rifleman divides the face of the target up like the face of a clock. Thus a hit at 12 o'clock is one directly above the bull's-eye, and a hit at 3 o'clock is one to the right of the bull, the bull's-eye being considered the center of the clock face.

raise your rear sight; if you want your shot to strike to the right move the sight to the *right* by means of the wind gauge.

Now we are confronted with another problem. How much shall we move the sight to give just about 12 inches correction in each direction?



Fig. 135

Firing around a building or tree—kneeling

There is no use in doing this by guess work, moving it perhaps too far, and not discovering this until we have fired a couple of more shots. Ammunition costs money, or we may be shooting in a match where errors in sight adjustment mean many points in the score. If we refer to the tables at the end of Chapter VIII we will there find the information necessary to correct to just the right amount. For example, if we are using the Model 1903 rifle with the sights set at 200 yards and zero for windage, we see from the table that 5.44 inches is the correction corresponding to a change in elevation of 100 yards when shooting at 200 yards. Twice 5.44 is 10.88 inches, which is approximately 12 inches (close enough for this purpose). We therefore elevate our sight 200 yards, or from 200 to 400 yards, and our next

shot will strike approximately 12 inches higher in relation to the point of aim than did the last one. For our windage we see from the Windage Correction Table that a point of adjustment on the wind-gauge scale is equivalent to a movement of 8 inches at 200 yards. Therefore a movement of a point and a half right will give us our required 12 inches correction. To sum up, for our first two shots which struck 12 inches low and 12 inches to the left, our sights were adjusted at 200 yards elevation, and zero for windage. We now adjust our sights to 400 yards elevation and $1\frac{1}{2}$ points right windage, and our rifle should strike where it is aimed at 200 yards.

Now take the same case exactly, but suppose that the rifle is equipped with the Lyman No. 48 rear sight. This sight has micrometer adjustments reading to minutes of angle, as explained in Chapter VII. One minute adjustment is equivalent to a change in point of impact of 1 inch for every hundred yards of range. At 200 yards 1 minute will change the point of impact 2 inches. Therefore we simply raise the elevation 6 minutes, equals 12 inches, and move the wind gauge 6 minutes or clicks to the right, equals 12 inches. This shows the convenience and simplicity of working with a sight which reads to minutes of angle.

Suppose on the other hand that we are using a Savage Model 1899 rifle, caliber .250-3000 Savage, equipped with a Lyman No. 30½ rear sight. With this sight we can calculate from the tables at the end of Chapter VIII that one point of elevation will change the point of impact 6.15 inches per every hundred yards of range, and one point on the wind gauge will similarly change the point of impact 2.46 inches.

There is frequently a tendency on the part of the novice to aim off to one side, or high, or low, to correct errors in sighting. For example, if the shot strikes to the right of the bull's-eye, the novice will often aim the next shot to the left of the bull in hopes of striking it. In target practice this is absolutely wrong, and should never be permitted. While one may get a good score once in a while by this method, there is too much memory and guess work about it. No good shot uses this method, and a rifleman working in this manner would never be tolerated on a rifle team. In target shooting one should make it an invariable rule always to aim normally, with the top of the front sight just below the bull's-eye, and then change the adjustment of the sights to bring the center of impact to the point of call.

The bullet will seldom strike *exactly* where the shot is called, because no rifle is absolutely accurate, nor can one call his shot exactly. A

good rifle is accurate enough to group its shots within a 10-inch circle at 500 yards, and in practice it has been found that expert riflemen can call their shots to within five inches of where they hit at this range and proportionately at other distances.

The following rules and tables of sight adjustment pertain to the United States rifle, Model of 1903, when used with the regular Model 1906 service ammunition. Those portions printed in italics should be memorized by the military rifleman.

RULES AND TABLE OF SIGHT ADJUSTMENT

United States Rifle, Model of 1903.

1. *Move your sight in the direction that you wish your rifle to hit.* That is, if you want your rifle to hit higher, raise your elevation. If you want it to hit to the right turn the wind-gauge screw so that the movable base moves to the right.

2. The numbers on the elevation scale on the sight leaf refer to the marks or lines *below* the numbers; for example, the figure 5 is above the 500 yard line. To set the sight at 550 yards, the index line (on either side of the corners of the triangle for the open sight, or on either side of the peep hole for the peep sight) must be clamped just half way between the "5 line" on the right side of the leaf, and the "6 line" on the left side.

3. The smallest marks or graduations on the wind-gauge scale are called "points." For convenience the line indicating each third point is made longer than the others. When the wind gauge is set at zero, the two zero marks on the fixed base are in line with the point lines at either end of the wind-gauge scale. When the wind-gauge is set at "1 point right" the movable base has been moved to the right so that the second line on the right side of the scale is in coincidence with the index or zero line on the right of the fixed base.

4. The sight must be set with the utmost accuracy. Look at it carefully in a shaded light, and see that it is not even a hair's-breadth off the reading desired.

ELEVATION TABLE

At 100 yards	a change of 25 yards in elevation	moves the shot	.7 inches.
At 200 yards	a change of 25 yards in elevation	moves the shot	1.6 inches.
At 300 yards	a change of 25 yards in elevation	moves the shot	2.8 inches.
At 400 yards	a change of 25 yards in elevation	moves the shot	4.3 inches.
At 500 yards	a change of 25 yards in elevation	moves the shot	6.2 inches.
At 600 yards	a change of 25 yards in elevation	moves the shot	8.6 inches.
At 700 yards	a change of 25 yards in elevation	moves the shot	11.6 inches.
At 800 yards	a change of 25 yards in elevation	moves the shot	15.4 inches.

At 900 yards a change of 25 yards in elevation moves the shot 19.9 inches.
At 1000 yards a change of 25 yards in elevation moves the shot 25.1 inches.

A convenient elevation rule to remember is: A change of 100 yards in the elevation used at any range alters the point of impact a distance equal to the number of inches contained in the square of the range. For example: At 500 yards, changing the elevation 100 yards changes the point of impact 25 inches ($5 \times 5 = 25$.)

WINDGAUGE TABLE

At 100 yards a change of 1 point on windgauge moves the shot	4 inches.
At 200 yards a change of 1 point on windgauge moves the shot	8 inches.
At 300 yards a change of 1 point on windgauge moves the shot	12 inches.
At 400 yards a change of 1 point on windgauge moves the shot	16 inches.
At 500 yards a change of 1 point on windgauge moves the shot	20 inches.
At 600 yards a change of 1 point on windgauge moves the shot	24 inches.
At 700 yards a change of 1 point on windgauge moves the shot	28 inches.
At 800 yards a change of 1 point on windgauge moves the shot	32 inches.
At 900 yards a change of 1 point on windgauge moves the shot	36 inches.
At 1000 yards a change of 1 point on windgauge moves the shot	40 inches.

A convenient wind-gauge rule which all should memorize is: *Moving the wind gauge 1 point moves the shot 4 inches on the target for every hundred yards of range.* For example, 100 yards, 4 inches; 200 yards, 8 inches; 500 yards, 20 inches.

GALLERY PRACTICE SIGHT ADJUSTMENT

In gallery practice, either with the .22 caliber United States gallery practice rifle, or with the regular Model 1903 service rifle, the most practical rule is: At 25 yards 1 point on the wind-gauge scale equals 1 inch on the target. Changing the elevation a distance equal to one point has a similar value.

THE MICROMETER SIGHT ADJUSTER

Expert military riflemen seldom rely upon their fingers and eyes to set their sights for ranges over 500 yards. There is a little too much guess work about it to produce the very best results in competitive shooting. Instead they use a little instrument called a "micrometer sight adjuster." This snaps on the leaf and slide of the sight, and contains the regular micrometer screw system and scale of adjustments. One minute on this instrument makes an adjustment equivalent to a change in point of impact of 1 inch for every hundred of yards range. Suppose one is shooting at 600 yards, and his shots are striking 12 inches below the center of the bull's-eye. Snap the micrometer on the sight and run it up 2 minutes, and the elevation will be exactly correct.

With this sight adjuster the rifleman makes his readings minutes of angle instead of yards. Thus for 600 yards his normal elevation will be "20 minutes" instead of, say, 625 yards. This instrument thus enables him to adjust his sight to inches on the target, and eliminates all guess-work. This considerably increases the accuracy, and the size of the scores at long range. At 800 and 1000 yards the rifleman adjusting his sights by hand and eye alone is hopelessly handicapped against the man using the micrometer sight adjuster. With this sight adjuster and the Model 1903 rifle, using .30-caliber Model 1906 service ammunition, it has been found that the amount necessary to raise the elevation from one range to another is approximately as follows:

From 200 to 300 yards raise	3 minutes.
From 300 to 500 yards raise	7.7 minutes.
From 500 to 600 yards raise	4.3 minutes.
From 600 to 800 yards raise	12 minutes.
From 800 to 900 yards raise	7 minutes.
From 900 to 1000 yards raise	8 minutes.

SIGHT ADJUSTMENT OF HUNTING RIFLES

All the foregoing pertains to sight adjustment of a rifle intended for target shooting on a bull's-eye target. With a rifle intended for game shooting it is not correct to adjust the sights so that the bull's-eye will be struck in the center when aim is taken at, or a little below, the bottom of the bull's-eye. Instead we should adjust the sights on such a rifle so that the bullet will hit the point aimed at. If the rifle is sighted in for hunting purposes on a bull's-eye target it is best to aim as one normally would on that target; that is, just below the bottom of the bull's-eye, but so adjust the sights that the bullet will strike at or near the bottom of the bull's-eye; that is, near the point of aim. Or the hunting rifle may be sighted in on a large, round, mouse-colored target, aim being taken at the center of the target, and sights adjusted until the bullets strike at the center. For 200 yards this target should be about 2 feet in diameter.

With a hunting rifle it is best to adjust the sights accurately for several ranges. First there should be a "point blank adjustment" say for 15 yards, so that one can aim, for example, at the head of a grouse at this short range, and be sure of decapitating it. Next the sight adjustment should be found for the "big game range," the sights being adjusted for that range at which the highest point in the trajectory does not raise over 4 inches. For a rifle of around 2000 feet per second velocity this would be about 150 yards, and for rifles around 2700 feet

per second velocity, 200 yards. With sights adjusted for this range one does not have to stop to estimate the range for all medium or close shots as the trajectory will not carry the bullet under or over an eight-inch circle representing the vital portion of a big game animal. Then the rifle should also be sighted in for longer ranges, say up to 400 yards, for long range shots at game, in which cases it will be necessary to estimate the range.

In most cases it is impractical to adjust sights in shooting at game unless the game is at a distance and undisturbed. It is best, if the game is beyond the big game range, to which the sights are set, to hold a little higher on the animal, say hold almost up to the back bone. One should never try to hold the front sight higher in the rear sight as this is the worst kind of a guess. So, too, it will in almost all cases be impractical to adjust the wind gauge for winds. Instead it is best to hold off just slightly for wind. If the wind is slight do not allow for it. If it is a moderate wind try to hold off about 8 inches for it at a range of 200 yards. If it is a very strong wind at this range hold on the windy side of the animal. Make no allowance for wind at ranges less than 200 yards with high-power rifles as there is very little deviation.

The advantage of adjustable sights on hunting rifles lies not so much in the ability to adjust them under hunting conditions, as in the ability to adjust the sights exactly correct for the various distances, both for elevation and windage, and to do this with the minimum amount of ammunition. Also the ability to make small changes in the sight adjustment which may be found necessary on account of changes in ammunition, changes in altitude, and changes in temperature. A good adjustable sight, like the No. 48 or No. 103 Lyman, will pay for itself in the time and ammunition expended in the first sighting in of the rifle.

CHAPTER XXIX

POSITION AND AIMING DRILLS

THE Small Arms Firing Manual" of the Army prescribes that the preliminary practice of organizations before starting the regular season's course of target practice on the rifle range shall include position and aiming drills. These drills are intended to teach the correct firing positions, to develop the muscles used in holding the rifle, to accustom one to the handling and manipulation of the rifle, to give practice in aiming, trigger squeeze, and calling the shot. They form a part of the daily instruction of all organizations for about a month prior to their going on the rifle range. The young soldier is prone to look upon these drills as very much of a bore, but the old and experienced shot realizes their value in putting one in the best condition for shooting, and in keeping him in this condition. No man who is really expert with the rifle neglects to practice these exercises regularly every day, and particularly for a month or so prior to, and during, the range practice season.

I have seen members of the national match teams, comprising the best shots in the world, spending hour after hour at these drills, snapping their rifles at miniature targets, going through all the movements, and using every bit as much care as though they were actually shooting in an important match. I have seen skilled shots sitting on a bed practicing inserting clips of dummy cartridges into the magazine of the rifle in order to develop and retain the skill which will insure that there will be no hitch of loss of time in this operation on the rifle range. I have seen men practicing rapid fire at a small target, immediately above which was a clock with the hour and minute hands removed, and a big tin second hand placed on it to give the correct time. I have practiced all these exercises myself, practically all the time for the past twenty years, and only thus have I been able to keep in shape for shooting all the time. The competition in rifle shooting is so keen among exports that they realize that they can neglect nothing which will improve their shooting, and keep them in form.

A number of position and aiming drills are prescribed in the "Small

Arms Firing Manual," but the most important ones are what are called the "trigger pull exercises." In these exercises miniature targets are used, and are placed either against the wall of the barracks, or arranged outdoors at a short range, so as to be at approximately the height of the man's eye when he aims in the various firing positions. The soldier assumes one of the firing positions, aims at the target, and fires with the empty rifle. In these exercises he uses all the care, and pays attention to all the little details, of position, breathing, holding, aiming, trigger squeeze, and calling the shot that he would if he were actually shooting in an important match or in record practice on the range with ball ammunition. The careful practice of these exercises in each of the firing positions for 15 minutes daily will do wonders in teaching one to shoot, and in getting one into shooting condition and keeping him there.

The rifleman or sportsman will find that a few minutes a day practice in his own room will do wonders in making him thoroughly expert in the handling of his rifle, and the novice will find that it will give him just that practice that he needs in holding, aiming, and trigger squeeze. The following suggestions regarding these drills will be found useful:

The target should subtend the same visual angle that it does in outdoor practice. For example, at 100 yards a target 2 feet square with a 5-inch bull's-eye is very satisfactory. Therefore for position and aiming drill, if the distance from the firer to the aiming target be 5 yards, the target should be one-twentieth of this size. Such a target should be made of a yellow paper, similar to wrapping paper, so that it will have the same appearance as the regular range target. In this way the rifleman in aiming will have almost exactly the same picture in his eye as he would on the outdoor range, and uniformity in aiming will result. Such targets should be suspended from the wall, in a well-lighted place, so that they are at the height of the rifleman's eye when he assumes the firing position.

The sportsman who has but one small room in which to practice, and who will desire to do most of his practice in the standing position, can get along very well with a small target made on thin, almost transparent paper, and pasted on the window pane. Such a target may be either a bull's-eye target, or it may be the silhouette of an animal, a deer, for example. A figure of a deer for use on a window pane at 3 yards should be about 1 inch long by half an inch high.

The sights should be adjusted to that range which the practice is to

simulate. The rifle is to be snapped at the target without ammunition. It does no harm at all to snap a bolt-action rifle. With a lever-action rifle it is best to introduce a small piece of rubber pencil eraser between the hammer and the firing pin for the hammer to strike on.

The standing and kneeling positions should be assumed the same as outdoors. In the sitting position the heels can be made secure by tacking small cleats to the floor in the correct position, or use a large door mat, large enough to both sit on and rest the heels on. In the prone position use a blanket folded to about four thicknesses to rest the elbows on.

Play the game fair. Use all the skill you are capable of to get a steady position, an accurate aim, and a clean trigger squeeze. Position and aiming drills carelessly performed are worse than useless. They teach bad habits, and are a positive detriment to good shooting. Hold the rifle as though you expected it to recoil; that is, as though it was loaded with a ball cartridge.

In practicing for target shooting hold yourself down to the same time limit you would have in competitions, and fire the same number of consecutive shots that would be required in a match. In practicing for game shooting fire slowly at first until you attain the skill to call a bull eight times out of ten, then speed your firing up to that point where you can get a good hold, good aim, and good trigger squeeze in two seconds after placing the rifle to the shoulder.

Rapid fire should be practiced also, with a view to perfecting oneself in both manipulation of the rifle, and quick aiming and trigger work. For such practice it is best to use dummy cartridges, as the feel of the working of the action is usually quite different with an empty rifle. Dummy cartridges can easily be made by taking empty shells, leaving the old primers in the shells, resizing the neck of the shells, and seating bullets. The powder is of course omitted. To distinguish such cartridges from ball ammunition, rub the shells with a little mercury which will turn them silver color. In using dummies place a folded blanket on the ground where the dummies will fall when ejected. This will save the dummies from becoming badly deformed.

Dummy cartridges may also be used to practice the rapid refilling of the magazine, a most important matter, particularly to the military rifleman.

There is almost no limit to the amount of good practice one can get in his own room. After becoming skilled in the standard firing

positions vary the positions slightly as one would have to in the field for quick shots where the level and precise footing could not always be looked after. A small moving target can be arranged to run along the window-sill, and this target can even be made to bound up and down like a deer. Also one can learn to shoot left handed.

Remember that all this practice is of no good unless the rifleman takes all the pains that he is capable of with each and every shot, just as though his life depended upon that very shot.

CHAPTER XXX

GALLERY SHOOTING

AFTER the beginner has learned the lessons of aiming, holding, and trigger squeeze, the next logical step is to gallery practice. By gallery practice is meant shooting at short range, either indoors or outdoors, with reduced charges or with .22-caliber rifles. In such practice one may gain experience and adeptness in aiming, holding, trigger squeeze, calling the shot, and sight adjustment, and more particularly in the proper co-ordination of all these. Moreover, gallery shooting is interesting work, and if the element of competition be introduced it is a keen sport. Gallery shooting is not only valuable for the beginner, but the expert shot realizes its value in keeping in shooting form, particularly during the winter months when the weather is too inclement for shooting outdoors with any degree of comfort. Practically every expert in the country who is actively competing now realizes the value of gallery work, and keeps it up all winter long.

There is almost no limit to the variety which may be introduced into work in the gallery. Not only slow fire, but rapid fire, and fire on moving targets may be introduced. One may have the ordinary black and white targets, or the targets may be painted a neutral color to simulate game in its native environments. In fact gallery shooting can be made practically the same as outdoor or field shooting except that of course weather conditions will always be the same and one cannot gain experience in making allowance for these. Gallery shooting is the same as outdoor shooting with the expense, recoil, noise, and weather conditions eliminated.

A few years ago the galleries commonly seen were those at places of amusement where one shot at iron targets at very short range with .22-caliber repeating rifles. One gained considerable amusement but very little practical experience. Of late years gallery practice has taken great strides due to the encouragement given to it by the War Department and by the National Rifle Association. Thousands of rifle clubs have sprung up all over the country, and these clubs almost invariably have indoor ranges which they use in the winter

time in conjunction with the outdoor range in the summer. Competitions by mail are now arranged among the various teams, and several leagues are in operation with very keen competition. The shooting conditions in these clubs simulate very closely outdoor military shooting. A number of the Schuetzen societies also have gallery competitions in the winter time, and several of these clubs in New York City have held annual competitions for the past twenty years.

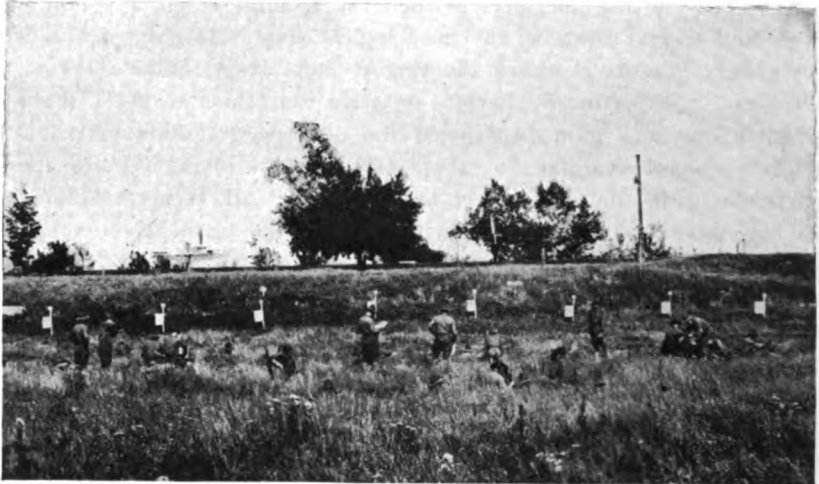

Fig. 136

An extemporized gallery range used at the Plattsburg Training Camp, 1916. The targets are tacked on boards hung from a wire fence. A railroad embankment acts as the bullet stop

In fact there are clubs operating indoor galleries in almost all large cities, and the rifleman can gain much profit and experience in joining one of these clubs and entering the competitions. The name and address of the secretary of the nearest club can always be obtained by addressing the Secretary, National Rifle Association, Washington, D. C.

It is also entirely practical for the individual rifleman to construct a gallery of his own wherein he can obtain all the practice he desires. Such a gallery need not be an elaborate affair. If one does not care about shooting at night time he can rig up a short range anywhere outdoors, a big packing box filled with sand being used as a bullet stop, and the paper targets simply being tacked on the box. The usual range is 25 yards. Ranges shorter than 50 feet are not very

satisfactory. If it is desired to shoot in inclement weather some sort of shelter should be arranged. One might fire out of a window or door, or if the cellar of the house be large enough a range can be made therein, the targets being illuminated by lights arranged as will be explained afterwards. If the cellar be not long enough it is sometimes possible to extend the range out the cellar window, or to dig a trench outdoors leading from an opening in the cellar wall. A trench two feet wide and two feet deep is large enough as it is only necessary to give room for the flight of the bullets, and for the placing of

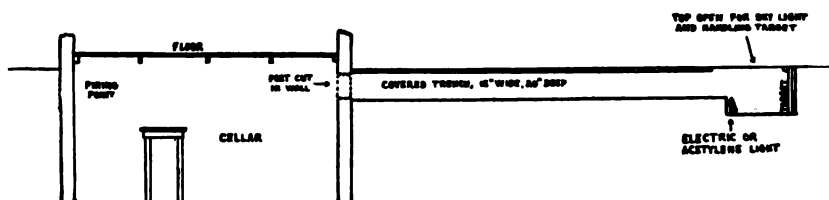

Fig. 137

Gallery range in cellar with covered trench dug in yard or garden to obtain the required distance to the target. The target is placed at the end of the trench. Target may be arranged so as to be operated from firing point by wire cable, cord, and wheel if desired as shown in Fig. 139.

the targets at the end of the trench. Using his ingenuity the rifleman can rig up a gallery range almost anywhere.

Galleries for rifle clubs are more elaborate affairs. These are usually placed in the cellar, or on the roof of some large building. A number of targets and firing points are arranged. The targets are usually supported on clamps hung on wires and so arranged that they can be run on the wires down to the butt for firing or pulled back to the firing point for marking or for changing targets by means of a wheel and handle at the firing point. The illustrations accompanying this chapter give the details of such a range, and there are several firms who make a business of equipping such ranges whose names can always be had by addressing the Secretary, National Rifle Association. With such galleries it is not necessary to have any markers at the targets. The target is placed in its clamp at the firing point, and the wheel turned until the target travels along the wire down to the butt. Here it rests against the bullet stop. Bullet stops may be constructed of steel plates set at an angle of 45 degrees so that the bullets striking the plates are deflected down into a box of sand below the plate. Or a box filled with sand may be placed back of the targets,

the wood facing of the box being replaced as it is shot away. Instead of sand the box may be filled with chunks of wood which is perhaps cleaner. A small telescope is rigged up on supports at the firing point, and as the rifleman fires each shot he looks through the telescope and sees where his shot has struck. After firing ten shots he reels his target back to the firing point and replaces it with a fresh target. When the target is in position for firing against the bullet stop it is

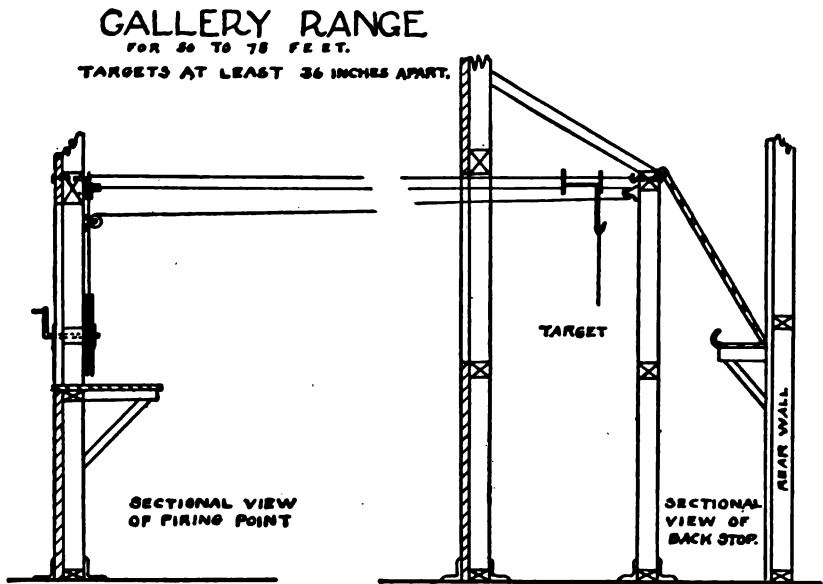

Fig. 138

Gallery range with travelling target. Side view (sectional) showing construction

illuminated by a series of lights and reflectors placed several feet in front of the target, and either above or below it as shown in the drawings. These lights may be electric, gas, oil, or acetylene. As the target is always at a certain height large benches are often provided at the firing point on which the rifleman can lie or kneel when firing in the prone or kneeling positions, thus bringing his rifle always approximately at the height of the target. The firing points on such ranges are always in semi-darkness, the rifle sights appearing as though silhouetted against the illuminated target, and very clear aim can be obtained in this manner.

In many of the large National Guard armories in this country there are gallery ranges as long as 100 yards. In fact one armory at least

has a 200-yard gallery range. Such ranges are often constructed exactly like outdoor ranges, with shelters below the targets at the butts from which the markers mark the targets, and telephone connection between firing point and targets.

A large variety of targets are used in gallery shooting. As a rule the black bull's-eye of the gallery target should be slightly larger in

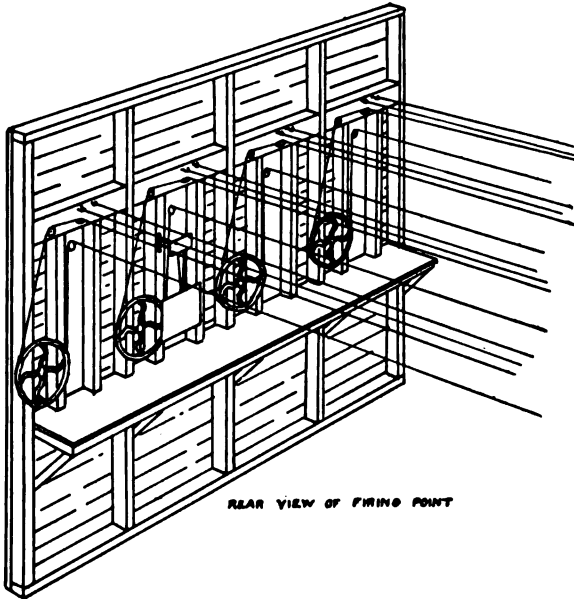

Fig. 138a

Gallery range with travelling target. View of back of firing point partition

proportion to the range than is the case with the outdoor target. Gallery targets are usually printed on light cardboard.

The rifles usually seen at the ordinary shooting galleries at pleasure resorts are the Winchester and Remington repeaters for the .22-short cartridge. These rifles are greatly handicapped by being equipped only with the ordinary factory open sights. One could do much better shooting with them were they provided with good adjustable peep sights with large cup discs. But these rifles are too light and small for the full-grown man, and the best results cannot be attained with them.

The gallery rifle used in the United States Army is known as the United States gallery rifle, caliber .22. In appearance, weight, and operation it is exactly the same as the United States rifle, Model 1903,

but the barrel is bored and rifled for the .22-short cartridge. This cartridge is not loaded directly into the chamber, but into a holder. The holder is of steel, and has the same general shape and appearance as the .30-caliber, Model 1906 cartridge. This holder contains a chamber for the cartridge, and a firing pin. Five holders can be inserted into the magazine of the rifle in exactly the same manner as cartridges are inserted into the magazine of the Model 1903 rifle. The striker of the rifle hits the firing pin of the holder which fires the cartridge. The .22-caliber bullet travels a slight distance through the holder before it leaves it, and jumps into the barrel. This arrangement makes the operation of loading the holders and working the bolt exactly the same as in the regular military arm, which was the result desired. These rifles when new shoot very well, although they cannot be compared in accuracy with a good .22-caliber rifle chambered in the regular manner. They need a great deal of attention to keep them in good condition. Both the holders and the barrel must be kept very clean, and care must be taken that the muzzles of the holders are not injured or deformed when ejected from the rifle, particularly in rapid fire. Some holders will be found which do not shoot accurately, and these should be laid to one side and not used.

By far the best rifles for gallery shooting, and this includes all shooting up to 100 yards on sheltered ranges, are the heavy Winchester and Stevens single-shot rifles chambered for either the .22-short, or the .22-long rifle cartridges. The .22-short is as good as the .22-long rifle up to 25 yards, but it is not suited for longer ranges. A rifle for the .22-short cartridge should be rifled and chambered for that cartridge alone. The continued use of the .22-short cartridge in a rifle chambered for the .22-long rifle cartridge will soon result in the ruining of the chamber, and the destroying of all accuracy. If one can afford the outlay by far the best outfit is a Pope barrel for the .22-long rifle cartridge fitted to a Winchester single-shot action. Such a rifle should have a full-sized shotgun stock, a trigger pull eased up to $3\frac{1}{4}$ pounds, and a forearm which will admit of the attachment of the regular military sling strap in the proper position. The entire rifle should weigh about 9 pounds.

The best sights for gallery use on such rifles are either the Lyman No. 104, which should be equipped with a cup disc, or the Winchester type A, 5-power telescope with a No. 2 rear mounting. Both of these sights have adjustments for elevation and windage which read to half minutes of angle. A half minute is equivalent to $\frac{1}{8}$ inch on the 25-

yard target, $\frac{1}{4}$ inch on the 50-yard target, and $\frac{1}{2}$ inch on the 100-yard target, and the rifleman will at once see how very convenient such adjustments are. A heavy single-shot rifle chambered for the .22-long rifle cartridge is accurate enough to require adjustments every bit as accurate as this.

One may also use his regular hunting rifle for gallery shooting,

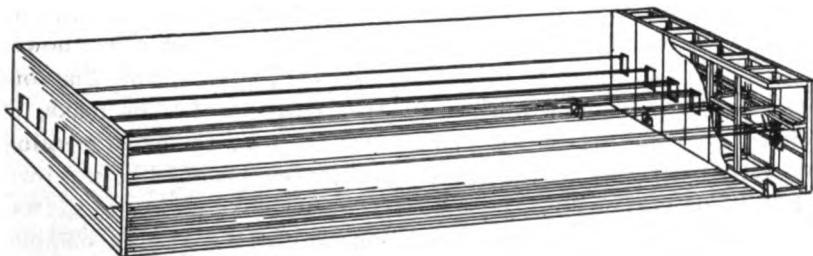

COMPLETE LAYOUT

Fig. 138b

Gallery range with travelling targets. View of complete range. Six firing points and thus gain the added advantage which comes from practicing with the same weapon that he will use in the field. If the rifle be of small caliber, from .25 to .35, it will work very well at short range with a reduced load. Data for loading reduced loads are given under each cartridge in Chapter XI. If the gallery be lighted with artificial light it will be found necessary to equip the rear sight with a large cup disc to get the best results, as the ordinary Lyman peep, or open sights, allow too much of the reflected light to come back into the eyes and good definition of the sights and target cannot be had.

During the years 1910 and 1911 I had available for my practice an excellent indoor gallery range which permitted firing up to 100 yards. I did a large amount of firing and experimental work on this range. Most of the work was done with two rifles. One was a Winchester single shot for the .22-long rifle cartridge. This rifle had a 27-inch, No. 3, round barrel, and weighed 9 pounds. It was equipped with gun-sling, set triggers, and a Winchester, type A, 5-power telescope sight. The other rifle was a standard Model 1903 military rifle, equipped with a Lyman No. 48 rear sight, with large cup disc. This rifle was also arranged so that the Winchester telescope sight could be fitted to it. Various kinds of reduced charges were used in the Model 1903 rifle. All the shooting for experimental purposes was done from a very steady muzzle and elbow rest, and all shooting was by artificial light.

In the experiments with the .22-caliber rifle it was found that the various makes of .22-caliber long rifle ammunition differed considerably in accuracy. The very best results with this rifle were obtained with a certain lot of Peters .22-long rifle cartridges loaded without crimp, especially for indoor rifle competition. I had obtained 3000 rounds of this lot all loaded on one machine from one lot of semi-smokeless powder, on one day. Other ammunition shot with various degrees of accuracy. Experiments with other .22-caliber rifles showed conclusively that each rifle had its own peculiarities, and that one rifle would do its best work with one particular lot, or make, of ammunition, and which lot could only be told by experimenting. Another Winchester barrel, to all appearances exactly like my own, did its best work with Winchester crimped ammunition fresh from the factory. The following tabulation shows the results obtained with my rifle with Winchester, U. M. C., and Peters long rifle ammunition. The group measurement is the average of ten consecutive groups of ten shots each. The elevation and windage figures show the correct setting of the No. 2 rear mount, it being remembered that one point on this sight is equivalent to an adjustment of one-half a minute of angle. As the wind gauge is moved to the right the readings increase. The groups were measured from center to center of shot holes farthest apart. The height of the cross-hairs of the telescope above the axis of the bore was 1½ inches.

TABLE OF SIGHT ADJUSTMENT AND ACCURACY

.22 caliber Winchester single-shot rifle. Winchester A5 telescope sight. No. 2 rear mount. .22-caliber long rifle cartridges. Shot from rest.

Ammunition	25 yards			50 yards			100 yards		
	Elev. ½ min.	W. G. ½ min.	Group In.	Elev. ½ min.	W. G. ½ min.	Group In.	Elev. ½ min.	W. G. ½ min.	Group In.
Rem.-U. M. C. Lesmok.	71	61½	.75	72	61½	1.95	84	62	3.96
Winchester Lesmok	71	62	.90	76	62	2.00	92½	61	4.03
Peters Semi-smokeless	69	60	.60	72	59	1.30	86½	58	2.61

Further tests showed that freshly loaded ammunition was always superior to ammunition that had been in store for some time, and that there is considerable deterioration in .22-caliber ammunition that has been held in store over one summer.

The results obtained with the Model 1903 rifle are shown in the tabulation below. Most of the firing was done at 100 yards, and for comparison the results obtained at that range with the lot of Win-

chester 150-grain ammunition with full charge selected for use in the national matches during the year 1911 are given, and also the results with a full-charged load that I was using at that time for game shooting. The sight readings are minutes of angle on the Lyman No. 48 rear sight.

TABLE OF SIGHT ADJUSTMENT AND ACCURACY
United States rifle, Model of 1903, 100 yards, rest.

Ammunition	Elevation, minutes	Windgauge, minutes	Group, inches
Winchester 150-grain service, 1911 National Match ..	2.50	0	2.30
170-grain spitzer soft-point. 46 grains Du Pont No. 20	4.50	2 right	2.92
Ideal bullet No. 308334. 25 grains Hercules Lightning	10.50	0	2.75
Ideal bullet No. 308241. 10½ grains Du Pont No. 75	16.	2½ right	3.00
Service jacketed spitzer bullet, 17 grains Du Pont No. 75 powder	11.	2 right	2.50

CHAPTER XXXI

EQUIPMENT FOR OUTDOOR RANGE SHOOTING

AFTER the beginner has learned the essentials of rifle shooting, has learned to co-ordinate the essentials in position and aiming drills, and has had some experience in gallery shooting, or at short range with a light rifle, he is ready to progress to outdoor-range shooting. Outdoor-range shooting may be called the college course of rifle shooting. It is here that the novice will learn the lessons that fit him to go out into the open with his rifle. It is here that the real science of shooting is developed and practiced. And it is here that we find the sport of rifle shooting most keenly developed. Outdoor-range shooting is essential for every rifleman. Even the expert shot finds it necessary to do considerable practice on the range to keep in form, and to learn and keep track of the peculiarities of his rifle.

An outdoor range may consist of anything from an extemporized arrangement consisting of a target nailed to a board, to a complete military range with its pits for markers, target carriers, firing points, telephone communications, etc. The construction of outdoor ranges will be taken up in Chapter XLIII. An outdoor range may be any distance from 100 to 1200 yards, but is seldom less than 200 yards.

A certain equipment is necessary for the rifleman who takes up out-door range shooting. The various articles of this equipment are enumerated and discussed here, the list including all the articles necessary for the shooting of the expert at both long and short range, and in practice as well as competitions. Not all of them are needed by the sportsman who simply practices outdoors to keep his hand in for the hunting season, nor are all of them always permitted in competitions and straight military shooting. Each rifleman can choose those which are necessary for his particular purpose.

CLOTHING

No special clothing is required for shooting, although if it be military shooting the participants will be required to wear the service uniform, including cartridge belt. Clothing for shooting should be loose and free, particularly around the arms, chest, and upper back. If a coat

or blouse be worn, it should be wide across the shoulders and upper back so that it does not bind when one assumes the prone position. It should be such that it will not be injured by lying on the ground. Most riflemen prefer to shoot in a flannel shirt. The elbows should be slightly padded to prevent the point of the elbow becoming sore from contact with the ground in the prone position. Several thicknesses of flannel, covered by one of chamois skin, is usually sufficient. The novice will usually find it advantageous similarly to pad the right shoulder to protect the shoulder from recoil, but the experienced marksman will not need this, and for him a covering of the shoulder with a piece of chamois skin to prevent the slipping of the butt plate will suffice. Much padding leads to clumsiness and a poor position. Some men will require a small piece of $\frac{1}{4}$ -inch rope sewed on the inside of the shirt or coat sleeve. This should be sewed on the inside of the back of the sleeve slightly below the arm pit, and makes a ridge above which the sling loop is placed when shooting prone, preventing the sling from slipping down to the elbow. The neck should be absolutely free, and it is best to open the top button of the collar of the shirt.

RIFLES

The rifle should be equipped with military or Whelen pattern gunslings, and with adjustable sights. Before starting to fire, the bore should be carefully wiped free from all oil and grease, and the action should be slightly lubricated with thin oil, like sperm oil. If the shooting is to be on the conventional black and white target, the sights should be blackened.

SIGHT BLACK

One cannot do good work with sights which glisten or shine. It is always best to blacken them. Sights may be blackened in the smoke of burning camphor, or a kerosene or acetylene lamp or torch, the flame of a candle, or even a match, or in the woods they may be nicely blackened in the smoke of burning pitch pine. Also a liquid sight black can be made as follows:

Ivory Black, "B" in Japan, (a black paste procurable from dealers in painters supplies) 5 ounces.
Gasolene, 76 test 12 ounces.

Add the gasolene little by little to the paste, mixing thoroughly after each addition. If it is found too dry with any gloss whatever there is too much "binder" in the paste; to correct this, add to the paste a little powdered lamp black, and work up thoroughly with the first portion of gasolene that is added. This mixture will dry on the sights in a few seconds.

Before attempting to blacken the sights, whether with smoke or liquid sight black, always wipe all traces of oil and dirt off of them. Do not blacken the entire rear sight, but only that portion around the peep hole or notch, leaving the elevation and windage scales without black so that they can be easily read.

AMMUNITION

Ammunition for use on the target range should be kept in some container where they will be kept clean, and away from sand, dirt, and hot sun. The cartridges are usually kept in the cartridge belt, or else in a "dope" or shooting bag.

SHOOTING BAG

Many riflemen who shoot extensively carry a shooting bag, usually called a "dope" bag, to the range with them. This bag carries all the articles used on the range with the exception of the rifle. A convenient bag is a small "dress suit case," about 10 inches wide, 14 inches long, and 4 inches deep. Sometimes compartments and loops are made in it for the various articles. A number of dealers in rifleman's supplies import special leather shooting bags from England which are very convenient.

MOBILUBRICANT

The users of high-power rifles usually carry a grease called Mobilubricant with which to grease their bullets before firing in order to reduce the amount of metal fouling deposited in the bore. (See Chapter XXII.) Mobilubricant can be carried in any small can, but is easiest applied in just the correct amount if contained in a little box called the "Spitzer Greaser" which can be obtained from dealers in riflemen's supplies.

SCORE BOOK

A score book is absolutely essential if one would learn and remember anything from his practice. A score book is not, as its name would imply, a book to keep the score alone in. It is intended chiefly to record the weather conditions, the elevation and windage used, the point on the target where the shot was called, and where it struck, and any details regarding rifle, ammunition, and the rifleman himself. It is really a ballistic record. There are a number of good score books on the market such as the "Bull's-eye Score Book," the "Marine Corps Score Book," or one can obtain from the Superintendent of

Public Documents, Washington, D. C., a copy of the official Army score book entitled "Soldier's Handbook of the Rifle and Score Book," by the author of this work. This last book is published in two editions, one for the Model of 1903 rifle, and the other for the Model 1917 rifle, and is arranged for the course prescribed in the United States Army. Special score books can be arranged for any particular kind of firing or practice. Every score book should have a pencil with it.

MICROMETER SIGHT ADJUSTER

This little instrument is absolutely essential for the best work at ranges over 500 yards when using the Model 1903 rifle. The hands and eyes alone cannot set the rear sight with a sufficient degree of fineness. It can be obtained from most dealers in riflemen's supplies. This instrument is not needed if one is using the No. 48 or 103 Lyman sights, or the Winchester telescope sight with No. 2 rear mounting.

TELESCOPE

For long-range shooting a high-power telescope is absolutely essential. It is needed to see the mirage which gives the best indication of the wind currents at long range. The power of the telescope should be 20 diameters or over. For seeing the bullet holes in the black portion of the target at 200 yards a power of 40 diameters is necessary. The writer has used for many years with excellent results a glass made by Bardou of Paris, magnifying 33 diameters, which cost \$17.50 from Montgomery, Ward & Co., Chicago, in 1903. Several English firms make excellent rifle-range telescopes, some of them having a device which allows various powers from 30 to 40 diameters to be used at will.

TELESCOPE RESTS

The telescope is used mounted alongside of the rifleman as he shoots in the prone position, usually on his right side, and almost parallel to the rifle barrel. To hold it in this position telescope rests are used. The rests hold the focused glass trained on the target. At any time, even when the rifleman is sighting, a slight turn of the head is all that is necessary to give him a view of the target through the telescope. Many elaborate rests have been designed for this purpose, but the best is simply two iron rods, about $\frac{1}{4}$ inch in diameter, and 15 inches long, pointed at the lower end, and with a fork or "U" at the upper end. They are simply stuck in the ground in approximately the cor-

rect position, the telescope opened out and placed on them. The telescope is focused on the target, and the rods moved slightly so that the glass stays trained on the target.

RIFLE REST

This is a small metal fork, somewhat like the telescope rest, but thicker and sturdier. It is placed in the ground just in front of where



Fig. 139

Firing point equipped for military shooting, showing telescope, rifle, rifle rest, score book, micrometer sight adjuster, and ammunition in position, and holes correctly made in the firing point for the elbows

the left hand will be when the rifle is held in the prone position. When one is not shooting the barrel of the rifle is rested in the fork in this rest, and the butt placed on the ground. This keeps the rifle standing straight up, only the toe of the butt touching the ground. The muzzle of the rifle does not get in the dirt. Grass does not wipe

the black off the sights. The hands are left free to handle the score book, ammunition, and sights. The left wrist is not under constant strain from holding the rifle up. Rifle rests can be obtained from any dealer in riflemen's supplies.

SHOOTING GLASSES

If one's eyes are normal, shooting glasses are of no assistance at all. Rather they are a handicap. If one has to wear glasses to obtain perfect vision, the glasses for shooting purposes should be equipped with "toric" lenses, preferably of amber color. The lenses should be very large, and should be contained in a spectacle frame of rustless metal. The glasses should be so adjusted that when aiming one looks through the lens as far from the rim as possible. Several optical firms make a specialty of shooting glasses for sportsmen.

CLEANING MATERIALS

As a usual thing the rifle will not require cleaning on the range. It is usually best to defer this until reaching one's home where all the facilities for a thorough cleaning are at hand. However, a rifle using black powder must be cleaned frequently to obtain the best results, also a rifle that has been shot with high-power ammunition will not do good shooting with a reduced load and lead alloy bullet until it has been thoroughly cleaned, so that it may sometimes be necessary to carry cleaning materials in one's range kit. This matter will be discussed in Chapter XLII.

CHAPTER XXXII

ELEVATION

WE have seen in Chapter XVI that a rifle is not always correctly sighted for a given range when the sights are set at the exact elevation as marked on the sights. Also an ordinary sporting rifle is not always correctly sighted for the range it is supposed to be when the rear sight is at its lowest elevation. The conditions which cause these differences may make it necessary to set the rear sight for elevation as much as 150 yards off the mark. That is, if we are shooting at 500 yards, it may be necessary to set the rear sight at 350 yards or at 650 yards in order to strike the bull's-eye with a normal aim. Or if the rifle be a sporting model with ordinary open sights, and supposed to be sighted for 100 yards when the rear sight is placed in its lowest position, it may shoot as much as 7 or 8 inches off the mark. If differences much greater than this are found it is likely that the rifle has suffered some injury. The rifle may have been allowed to fall at some time, thus springing or bending the barrel or sights, or there may be a slight injury or wearing of the rifling at the muzzle. It cannot be too strongly impressed upon the rifleman that he must take the best care of his weapon. Particularly he should never allow it to fall, and he should guard the muzzle and sights carefully. See that the muzzle of the bore receives no wear in the process of cleaning the bore, for if the sharp corners of the lands and grooves at the muzzle are worn or injured there will be a considerable change in where the rifle shoots. A worn muzzle does not necessarily mean an inaccurate rifle, but it does usually mean one which will shoot 'way off from its normal sighting.

If the rifle has received anything like fair treatment since it left the factory or arsenal, it should shoot quite close to the mark, provided proper and good ammunition is used. Thus if the rifleman sets his sights at the indicated range, and does his part of holding, aiming, and trigger pull correctly, his first shot will almost surely strike a target the size of the regulation military target at ranges up to 600 yards. He can then make the correction in sight adjustment necessary to hit the bull's-eye with the next shot. Once he has found the

correct elevation for a certain range he should record it in his score book, together with all the conditions as to ammunition, weather, etc., pertaining when the shot was fired. The correct elevation found for a given range under good and average weather conditions, with good ammunition, is termed the "normal elevation" for that range.

A rifle may slightly change its normal elevation from time to time. A new rifle will change its elevation a little during the firing of the first 100 shots or so, when the bore is losing the polish given to it by the tools with which it was bored and rifled, and taking on the polish it receives from the passage of the bullets through it. Also during this period the rifle is being pounded down to a set position in the stock. It is necessary to see that the guard screws, and other screws fastening the stock and forearm to the action, are kept screwed up very tight. A rifle with a loose stock will shoot all over the landscape. With a military rifle having a long forearm it is necessary to see that the wood under the upper band does not bind the barrel and interfere with its free expansion and lengthening as it heats up from firing. In a dry climate ordinarily no attention is necessary to this, but if the rifle be taken into a very damp climate the stock will swell, and then it will be necessary to dismount the rifle and work down the wood under the upper band with a piece of sandpaper in the groove where the barrel lies. This should not be overdone; it should be just possible to move the barrel very slightly where the upper band grips it.

A black powder rifle usually requires cleaning every five or ten shots to do its best work. A .22-caliber rifle using Lesmok or semi-smokeless powder should be cleaned after about every 50 rounds. But a high-power smokeless powder rifle should shoot well, and maintain its normal elevation very closely, provided it is not shot fast enough to become abnormally hot, or it is not so roughly bored that it accumulates a large quantity of metal fouling. If a rifle barrel gets very hot it is liable to shoot high and require a reduction in elevation of the rear sight, but it may shoot off in any direction, depending much on the steel of the barrel, and whether the bore has been hammered to straighten it during the process of manufacture. Ordinary heating such as would occur through the firing of 20 shots in 10 minutes, or even one string of rapid fire (firing 10 shots in 1 minute) should make no difference in the normal elevation of a good barrel. If a rifle throws its shots farther and farther from the mark as it heats up from firing at an ordinary rate, if it starts to shoot

higher and higher, or departs in some other direction from its normal, it is usually a sign that either the bore is not straight, or it has been bored crooked at the factory and then hammered to straighten it. A properly bored barrel shot with good ammunition will not accumulate enough metal fouling during an ordinary day's shooting on the range to cause it to depart from its normal elevation.

An accurate rifle, using the best ammunition with weighed powder charges, should hold its elevation to within 3 minutes of angle at ranges up to 1000 yards. That is, at 200 yards the shots should not string up and down more than 6 inches, at 500 yards 15 inches, and at 1000 yards 30 inches. Some rifles will do much better than this. A high-power Pope barrel for the .30-caliber Model 1906 cartridge will frequently hold its elevation within 1½ minutes of angle.

The elevation is also influenced by atmospheric conditions. Some of these atmospheric conditions which may influence the elevation are as follows:

Temperature. On a hot day the rifle will shoot slightly higher, and will require a slightly lower elevation of the rear sight. The reverse pertains on a day colder than normal. Ammunition which has been allowed to lie in the sun on a hot day long enough to get very hot is also liable to shoot high.

Barometer. The lower the barometer, the higher the rifle will shoot, and the less will be the elevation required. Low-velocity rifles and black-powder rifles are more influenced by changes in barometer than rifles of very high velocity. Rifles having velocities of 2700 feet per second and over are only influenced about half as much by changes in barometer as rifles with velocities around 2000 feet per second. At high altitudes a rifle will shoot higher and require a lower setting of the rear sight than it does at the sea level.

Mirage. Mirage or heat waves apparently make the target dance or simmer. The atmosphere appears to boil, and the target and bull's-eye appear blurred. The blurred bull's-eye looks larger than a sharply defined bull's-eye seen at times when there is no mirage. In trying to aim the correct distance below the bull's-eye the rifleman naturally aims a little lower on a blurred bull's-eye, hence his shot strikes a little lower on the target. Therefore when mirage is present a slightly higher elevation will usually be necessary. Ordinary mirage does not displace or drift the image of the target.

Light. Differences in light make almost no difference when the peep sight is used. If the rifleman be wearing amber-colored glasses and

using the peep-sight, changes in light will not make the slightest difference and may be entirely disregarded. With the open sight light sometimes has considerable effect on the elevation on account of the difference in the appearance of the sights in different lights. Different conditions of light may affect individuals differently, depending much on the strength and vision of the eyes, so that it is impossible to prescribe any exact rule. The light may be very bright, ordinary sunlight, dull, dark, or very dark over the entire range. We may have a target strongly illuminated by sunlight or under the shade of a cloud or some object, and we have bright or shaded sights, and all combinations of these. The effect of light with open sights must be found by each individual for himself, and the best way to do it is to keep a complete record of the light in the score book, so that after a number of scores have been fired the effect of the light can be determined by the elevation used and the place where the shot struck the target in that particular light. The best way to record the light in the score book is, "B-B" equals bright firing point and bright target; "B-D" equals bright firing point and dull target, etc.

Ammunition. Differences in ammunition of course make a large difference in the elevation required. High-power ammunition almost always requires a lower elevation in a certain rifle than do reduced loads. Differences on lots of ammunition to all intents and purposes practically the same sometimes make a change in elevation necessary. One can usually rely on all ammunition packed in one original box of 1000 or 1200 rounds at the factory being from one lot and made on one machine on one day. The kind of ammunition, and if possible the date of loading, should always be recorded in the score book, unless one is shooting his entire practice with one lot. Ammunition for the .30-caliber Model 1903 rifle manufactured during peace times is very constant and regular in its elevations, and when using it only very slight changes in elevation will usually be found necessary when changing from one lot to another. But if one were to change from this ammunition to another of the same caliber, but made by a private manufacturer, particularly if a different weight bullet is used, the change in elevation required might be considerable. For example, with the .30-40 cartridge fired in a heavy No. 3 barrel which is much less subject to slight changes in elevation from differences of ammunition than is a light military or hunting barrel, and using Winchester, U. M. C., Peters, and U. S. C. Co. ammunition, all loaded with a 220-grain, soft-point bullet, and all said to give a velocity at

the muzzle of 2000 feet per second, it was found that there was a difference in the point of impact between two makes of as much as 5½ inches at 100 yards.

Winds. Head winds, that is, those blowing from the target towards the firer, require additional elevation. Rear winds require a lower elevation. The effect of these winds at ranges up to 1000 yards is very small, and scarcely ever need be taken into account.

Positions. The position assumed by the rifleman influences the elevation considerably. In the prone position with tight gun-sling pulling down on the barrel, the rifle shoots lower than when held in any other way, but probably shoots more consistently if care be taken to get the same amount of tension on the sling each time, and to receive the recoil on the shoulder in the same way. In practice, however, there is very little difference in shooting at a bull's-eye target between the elevation in the prone position and that required for the standing position, because in the latter position one does not hold as steadily, and hence naturally holds a little farther below the bull's-eye with a little more of the white target showing between the top of his front sight and the bottom of his bull's-eye so that he can get a clearer view of the bull's-eye as his sights bob and travel over the surface of the target. When firing with a sand-bag or other rest the rifle shoots higher and requires a lower elevation. These differences depend so much upon the manner in which the rifleman holds, the manner in which he takes up the recoil, and the nature and position of the rest if any is used, that no general rule can be given. In some cases the differences may be so small that they can only be noticed by a very expert rifleman equipped with an exceptionally accurate rifle. Under other conditions that may make two or three feet difference at 500 yards, and proportionately at other ranges.

Oil in the bore. In the preceding chapter directions were given to wipe all the oil from the bore before beginning to fire. It is wise to do so. If the bore be heavily coated with a thick grease the first shot is liable to fly high and wild. Light oils like "3 in 1" and sperm oil do not have this effect as a rule, and if the bore of a high-power rifle be free from heavy grease the point of impact of the first shot from a clean bore, and of succeeding shots will be practically the same. If the bore of a .22-caliber rifle, or of a black-powder rifle be clean, and even slightly oiled with a light oil the first shot will almost always strike high on the target.

As a general rule the elevation is influenced very little by atmos-

pheric conditions because a change in one condition is usually accompanied by an opposite change in some other condition. For example, an increase in temperature is usually accompanied by a certain amount of mirage. Occasionally, however, conditions combine to make a big change in elevation necessary. Suppose that the weather on a certain range has been generally cool, but on a certain day it becomes very hot, the barometer drops, and a strong rear wind sets in to blow. Such conditions would cause the shot to go way over the top of the target if one were shooting at 1000 yards, using only the normal elevation and not taking into account the changed conditions. The normal elevation should always be used for the first shot of a score unless conditions clearly indicate that a change in elevation is desirable.

CHAPTER XXXIII

ZERO

THE "zero" of a rifle is the point at which the wind gauge must be set in order to have a perfectly pulled shot strike in a perpendicular line running through the center of the bull's-eye on a day when there is no wind, and when the sun is directly overhead, or else not showing in the sky. This zero should of course coincide with the zero on the wind-gauge scale, but owing to the differences in aiming and holding of the individual, the peculiarities of different rifles, etc., it often varies a little to one side or another. This zero of the rifle is the point from which all windage allowances must be figured. For example, if a certain wind requires an allowance of "1 point right" on the wind gauge of the Model 1903 rifle, and the zero of the rifle is a half a point right, then the wind-gauge must be set to read $1\frac{1}{2}$ points right. Similarly, if one point left wind is required to allow for the breeze, and the zero is $\frac{1}{2}$ right, the wind gauge must be set at only $\frac{1}{2}$ point left.

There are two ways of finding the zero. First, the rifle may be shot on a day when there is no wind blowing, and when the sun is either directly overhead or the sky is overcast, and the reading of the wind gauge which gives shots in or near a perpendicular line through the center of the bull's-eye taken as the zero. This method is the surest, but is open to the objection that on some rifle ranges a day with no wind is very rare. The second method is to shoot the unknown rifle alongside of some good shot who is using a rifle that he knows the zero of, and then comparing the two wind-gauge readings.

The reason for being so particular about the direction of the sun is that if it be shining on one side of the front sight, the rifle will shoot away from that side. This is even true of a perfectly black military sight, and the difference is considerable if one is using a bead front sight which is tapered or rounded towards the eye. With the black sight on the United States rifle, Model of 1903, if the sun is behind a cloud, and then comes out, lighting up the right side only of the front sight, it requires the wind gauge to be moved about a

quarter of a point to the right to compensate for seeing the right side of the sight more clearly than the left.

If the beginner is using the Model 1903 rifle he need not worry about the zero because it will seldom be off more than half a point, and this is not enough to cause him to miss the target. A half a point on the Model 1903 rifle only makes a difference of 10 inches at 500 yards and proportionately at other ranges. His first shot will strike the target, and then he can adjust his sights to the correct setting. The military shot should, however, always learn his zero very accurately before he begins rapid fire, because while in slow fire he has a chance to correct his windage after the first or any succeeding shot, in rapid fire he does not have this chance, and if the sights are not set right for wind, not only will the first shot go wrong, but all the others also. For a military rifle 500 yards is the best range at which to determine the zero, and for a hunting rifle, 200 yards.

When the rifleman knows the normal elevation and zero of his rifle he is prepared for accurate shooting, for qualification, for competition, or he is ready to take that rifle into the field after game. Until these are determined his shooting must be largely experimental, or, as it is termed in the "Small Arms Firing Manual of the Army," "instruction practice." The experienced rifleman, if he is starting the season's practice with a new rifle, shoots it carefully at all ranges, keeping all the while every speck of data most carefully in his score book. In a few days he will be able to determine absolutely his elevations and zero from this data. He then knows his rifle. Some men trust to memory in these matters, but their shooting can never be absolutely relied upon, nor are they ever found among the prize winners in a big match.

CHAPTER XXXIV

WINDAGE AND WINDS

THE wind is the greatest disturbing factor to the flight of the bullet that the rifleman has to contend with. The effect of the wind blowing on the side of a bullet flying through the air is to cause it to travel slightly with the wind. Thus if a wind coming from the shooter's right is blowing on the right side of the bullet, the bullet will drift to the left, and instead of hitting the bull's-eye it will strike over toward the left side of the target. To compensate for this we must either aim to the right or adjust our wind gauge to the right. The target and military shot always uses his wind gauge and never aims off for wind allowance, but there is seldom time for the hunter to do this, and he must aim a little to one side or the other. It remains to be seen just how much to adjust the wind gauge, or how far to one side to hold to allow for a certain velocity and direction of wind.

Wind will affect a large bullet more than it will a small one, and it will affect a slow flying one more than it will one flying at high velocity. In the first case the wind has more surface to act against, and in the second case it has more time to act on a bullet at low velocity than on one travelling rapidly, because the slow bullet will be exposed much longer in travelling the same distance. The exact wind allowance for the various military cartridges, has been very carefully calculated and tables of allowances prepared which are appended to this chapter. No such tables, however, have ever been computed for purely sporting cartridges, but today sporting cartridges so much resemble those used for military purposes that it is usually possible to use one of the military tables, making slight allowances where the velocities or size of the bullet differ considerably.

In speaking of the direction of the wind riflemen consider the rifle range as they would the dial of a clock with the target at 12 o'clock and the firing point at 6 o'clock. Thus a wind blowing from the right at exactly right angles to the line of fire would be called a 3 o'clock wind, and a wind blowing straight towards the rifleman would be a 12 o'clock wind. A 3 or 9 o'clock wind has the greatest deviating effect on the bullet because these winds strike the bullet squarely on

its side, and this defect decreases as the direction approaches 12 or 6 o'clock, until when the wind is in either of these latter directions it causes no lateral drift to the bullet at all. A 2, 4, 8, or 10 o'clock wind has about seven-eighths of the effect on a bullet that a 3 or 9 o'clock wind would, and a 1, 5, 7, or 11 o'clock wind has about half the deviating effect of a 3 or 9 o'clock wind. Winds blowing from 3 or 9 o'clock have exactly the same deviating effect, although of course in exactly opposite directions. Similarly 2, 4, 8, and 10 o'clock winds, and 1, 5, 7, and 11 o'clock winds have each the same deviating effect.

The direction of the wind can be told by holding a light string in the fingers and watching in which direction it blows out, by lighting a match, or by a puff of smoke if the wind is very light, by throwing grass into the air and watching the direction in which it is blown. If the wind is fairly strong its direction can instantly be told by facing towards the wind until it seems to whistle equally past both ears; one will then be facing squarely into the wind. Holding up a wet finger and noting the cold side is another old trick.

Estimation of the velocity of the wind will always remain largely a matter of guess work because no instruments or flags with which to measure it are allowed on the rifle range in military rifle shooting, and even if it were possible to have an anemometer alongside one while firing it would give only the velocity of the wind at the firing point, whereas the bullet is most effected by the wind directly in front of the target. What appears to be a very steady wind is in reality constantly varying from 3 to 6 miles per hour, and is seldom the same at any point, over a range of several hundred yards. Much can be learned by experience, and some few men become almost uncanny in their ability to estimate wind velocity. To say that a certain coach or shot is a good "wind doer" is to pay a high compliment. The velocity of the wind is measured in miles per hour. A wind blowing at 2 miles per hour is probably the lightest wind that will make itself manifest to the ordinary man. Up to 5 miles per hour one would call a wind gentle or light. From 5 to 10 miles per hour it becomes a nice breeze. From 10 to 15 miles is a stiff breeze. Fifteen to 20 miles per hour is a very strong wind, while anything over 20 miles per hour is in the nature of a gale, and it is hardly worth trying to shoot. Estimating the wind in this way the target shot or military rifleman will come close enough to it so that if he sets his wind-gauge in accordance with the tables he will be sure to get the first shot on the target, and usually pretty nearly correct for the wind. He can

then make the corrections necessary to carry his point of impact into the bull's-eye. In the case of military rifle shooting with the .30-caliber Model 1903 rifle, suppose the wind is blowing from 3 o'clock, a rather stiff breeze, and the rifleman is about to fire at 500 yards. A stiff breeze is from 10 to 15 miles per hour. Let us estimate this at 12 miles. The rifleman turns to the table of wind allowances for this rifle (Model 1906 ammunition) and using the "3 or 9 o'clock" column, follows it down to the 500 yard space and there looks for a 12-mile wind. The table shows this to require an allowance of $1\frac{1}{2}$ points. He sets the wind-gauge $1\frac{1}{2}$ points *right* from the zero of the rifle, and enough allowance will have been made to insure the first shot hitting the target, in fact it will probably come pretty near striking in a vertical line passing through the bull's-eye. In this case the table has been arranged for the wind-gauge on the United States magazine rifle, Model 1903. On this rifle the smallest division on the wind-gauge, called a "point," has a value of 4 inches per 100 yards. That is to say, moving the wind-gauge one point will move the point of impact four inches at 100 yards and proportionately at other ranges. In the example used above, $1\frac{1}{2}$ points has a value of 30 inches at 500 yards. By carefully recording wind directions, approximate velocities, the allowance one makes on the sight or by holding off, the length of the range, and the exact point where the shot fired under these conditions has struck, and then carefully studying these records, any one can quickly become a fair wind doper.

The range at which the big game hunter fires is almost always under 300 yards. With a modern, high-velocity rifle, like one using the .30-caliber, Model 1906 cartridge, it is seldom necessary at a short range like this to make any allowance for the wind. With this cartridge a 3 o'clock wind at 12 miles per hour would require an allowance of only about 9 inches at 300 yards. With the .30-30 rifle and the same wind and range an allowance of about 36 inches. The .30-40-220 rifle would require about 27 inches, and the .405 W. C. F. about the same as the .30-30.

The hardest condition of all for the target and military shot to shoot in is when a "fish-tail" wind is blowing. The direction of the wind is never absolutely constant, it always varies a little bit in the direction from which it comes. What we call a 3 o'clock wind will vary from 2:30 to 3:30 o'clock. If the wind happens to be a stiff one from 12 or 6 o'clock it will shift a little from one side to the other, and often these shifts come so quickly that one cannot see

them soon enough to allow for them. In a stiff breeze, 10 to 15 miles per hour, a wind from 6:30 o'clock has enough deviating effect to make necessary quite a little allowance. If one allows for such a wind, and when he is aiming the wind suddenly shifts to 5:30 o'clock, which it can do very easily without the ordinary man being aware of it, the marksman is going to find his shot way over on one side of the

TABLE OF WIND ALLOWANCES

.30 caliber Model 1898 cartridge (.30-40). 220-grain blunt bullet. Velocity 1960 feet per second.

Arranged in inches' deflection and points of windage on the Model 1901 rear sight for the .30-caliber United States magazine rifle, Model of 1898 (Krag).

Distance	Force of wind in miles per hour	Number of inches bullet is deflected at target, and number of points on wind gauge necessary to correct					
		By 1, 5, 7 and 11 o'clock winds		By 2, 4, 8 and 10 o'clock winds		By 3 and 9 o'clock winds	
		Inches deflection	Points on wind gauge	Inches deflection	Points on wind gauge	Inches deflection	Points on wind gauge
200 Yards 1 point on wind gauge gives 12 inches correction at target.	4	2	1/6	4	1/6	5	1/2
	8	4	1/3	8	1/3	10	1
	12	6	1/2	12	1	15	1 1/4
	16	8	2/3	16	1 1/6	20	1 2/3
	20	10	3/4	20	1 1/3	25	2
500 Yards 1 point = 30 inches	4	8	1/4	16	1/2	20	2/3
	8	16	1/2	32	1	40	1 1/3
	12	24	3/4	48	1 1/2	60	2
	16	32	1	64	2 1/6	80	2 1/3
	20	40	1 1/4	80	2 2/3	100	3 1/3
600 Yards 1 point = 36 inches	4	11	1/3	21	2/3	26	2/3
	8	21	2/3	42	1 1/6	52	1 1/2
	12	31	1	62	1 5/6	78	2 1/6
	16	42	1 1/6	83	2 1/2	104	3
	20	52	1 1/2	104	3	130	3 2/3
800 Yards 1 point = 48 inches	4	19	2/3	38	3/4	48	1
	8	39	3/4	77	1 5/6	96	2
	12	58	1 1/6	115	2 2/6	144	3
	16	77	1 5/6	154	3 1/4	192	4
	20	96	2	192	4	240	5
900 Yards 1 point = 54 inches	4	23	1/2	45	5/6	56	1
	8	45	5/6	90	1 2/3	112	2
	12	67	1 1/4	134	2 1/2	168	3
	16	90	1 2/3	179	3 1/3	224	4 1/6
	20	112	2	224	4 1/3	280	5 1/6
1000 Yards 1 point = 60 inches	4	29	1/2	58	1	72	1 1/6
	8	58	1	115	2	144	2 2/6
	12	87	1 1/2	173	2 5/6	216	3 3/6
	16	115	2	230	3 3/6	288	4 4/6
	20	144	2 2/6	288	4 4/6	360	6

TABLE OF WIND ALLOWANCES

.30 caliber Model 1906 cartridge in United States Model 1903 rifle 150-grain pointed bullet, M. V. 2700 feet per second.

RANGE No. of inches correction at target corresponding to 1 point of windage on rear sight of U. S. Magazine Rifle, caliber .30, Model 1903.	Correction in points of windage for winds in miles per hour blowing from											
	1, 5, 7 or 11 o'clock				2, 4, 8 or 10 o'clock				3 or 9 o'clock			
	Wind	Points	Wind	Points	Wind	Points	Wind	Points	Wind	Points	Wind	Points
200 Yards 1 point = 3 inches	2	0	12	¼	2	0	12	½	2	0	12	½
	4	0	14	¼	4	0	14	½	4	¼	14	½
	6	0	16	¼	6	¼	16	½	6	¼	16	½
	8	¼	18	¼	8	¼	18	½	8	¼	18	¾
	10	¼	20	½	10	¼	20	½	10	½	20	¾
300 Yards 1 point = 12 inches	2	0	12	½	2	0	12	¾	2	¼	12	¾
	4	¼	14	½	4	¼	14	¾	4	¼	14	1
	6	¼	16	½	6	¼	16	1	6	½	16	1
	8	¼	18	½	8	½	18	1	8	½	18	1¼
	10	¼	20	¾	10	½	20	1	10	¾	20	1¼
500 Yards 1 point = 20 inches	2	¼	12	¾	2	¼	12	1¼	2	½	12	1½
	4	¼	14	¾	4	½	14	1½	4	½	14	1¾
	6	¼	16	1	6	½	16	1¾	6	¾	16	2
	8	½	18	1	8	¾	18	1¾	8	1	18	2¼
	10	½	20	1¼	10	1	20	2	10	1¼	20	2½
600 Yards 1 point = 24 inches	2	¼	12	1	2	½	12	1½	2	¾	12	1¾
	4	¼	14	1	4	½	14	1¾	4	¾	14	2
	6	½	16	1¼	6	¾	16	2	6	1	16	2½
	8	½	18	1¼	8	1	18	2¼	8	1¼	18	2¾
	10	¾	20	1½	10	1¼	20	2½	10	1½	20	3
800 Yards 1 point = 32 inches	2	¼	12	1¾	2	¾	12	2¼	2	½	12	2½
	4	½	14	1½	4	¾	14	2½	4	¾	14	3
	6	¾	16	1¾	6	1	16	3	6	1¼	16	3½
	8	¾	18	2	8	1½	18	3¼	8	1¾	18	4
	10	1	20	2¼	10	1¾	20	3½	10	2¼	20	4¼
1,000 Yards 1 point = 40 inches	2	¼	12	1¾	2	½	12	3	2	½	12	3½
	4	½	14	2	4	1	14	3½	4	1¼	14	4
	6	¾	16	2¼	6	1½	16	4	6	1¾	16	4½
	8	1¼	18	2½	8	2	18	4½	8	2¼	18	5¼
	10	1½	20	3	10	2½	20	5	10	2¾	20	5¾

target, or it may even miss the target. In effect, in this case, he has actually fired with an allowance for a left wind when he should have had an allowance for a right wind. If the rifleman be a novice and does not appreciate the fish-tail nature of the wind, he is apt to be all at sea. Such occurrences as this will play hob with a man's score, and there is no way out of it until one learns to use the telescope to judge wind drift which will be explained elsewhere. Firing in a strong fish-tail wind is apt to discourage the novice, and it is better not to attempt target shooting on such a day until one becomes expert.

An expert, as a rule, loves such a day because it gives him a chance to show his skill.

The expert long-range shot judges slight changes in direction and velocity of the wind by means of the mirage. Mirage is the waves of heat, that bubbling or boiling of the atmosphere, which can be usually seen on a hot summer day. It is almost always present in the summer time, and although often so faint that it cannot be seen with the naked eye it can almost always be distinguished by means of a high-power telescope. A telescope magnifying twenty diameters



Fig. 140

A rifleman looking through his telescope and judging the wind by mirage drift or over is good for watching the mirage. If one will set the telescope in a rest and focus it on the target when mirage is present he will notice that the mirage has a decided movement or flow, something like the flow of a stream of water, or of a fog driven by the wind. The direction and velocity of this flow or travel can be seen by watching it carefully through the glass. The least little current of air causes a movement in the mirage.

The actual velocity of the wind cannot be told by the mirage alone. For that one must depend on instruments or on observation of flags, or make an estimate as before described. The wind-gauge is set for this estimate in the usual manner, and the telescope set up on its rests alongside the rifle. Just before firing the first shot glance through the telescope and note exactly how the mirage is flowing, and the apparent velocity of it. Then fire the first shot, and immediately glance through the telescope again to see if it has changed in the slightest.

Note where the first shot struck the target and if it is not right for wind make the necessary change in the adjustment of the wind gauge. If the second shot is correct for windage try to get every shot off with the mirage flowing exactly the same as it was for that shot. Watch the mirage closely through the glass before and after every shot. When the mirage appears to be running just right shift the eye from the telescope to the rifle sights and fire as soon as possible. Immediately after firing shift the eye back to the telescope to see if, perchance, it has changed, as that would give the reason for an off shot.

The mirage may appear to flow steadily to the right or left. It may flow very slowly or very rapidly, and it may change from very slow to very rapid almost instantly. It may boil straight up without any lateral movement. When the mirage travels from left to right it of course shows a wind blowing from left to right. When it boils straight up it shows either a wind straight from 6 or 12 o'clock, or else no wind at all. If the mirage be flowing slowly from left to right, for example, and the wind gauge be set for such a flow, and then at the instant of firing the mirage begins to travel very fast in the same direction, if one is shooting at 1000 yards the shot may hit anywhere from 2 to 4 feet to the right of the point of aim. And yet in most cases the change in wind which caused this sudden change in mirage flow cannot be seen or appreciated at the firing point in any way except by watching the mirage through the telescope.

It is in fish-tail winds that the watching of the mirage becomes absolutely necessary if a good score is to result at long range. A fish-tail wind is one blowing from head or rear, and constantly shifting a little bit from one side to the other. The mirage may be flowing steadily to the right with slow movement, then instantly change and flow very fast to the left, then as quickly change again to boiling straight up. By watching mirage in a fish-tail wind through the glass for several minutes it will probably be noticed that for the most of the time it flows in a certain direction at a certain velocity. The wind gauge should be set for this flow, and the rifleman should keep his eye at the telescope until he sees that the mirage is running steadily in this manner, and then get his shot off as soon as possible before it has had a chance to change.

It is hard to describe this on paper, and yet it is not difficult to learn mirage judgment of the wind. Several days spent on the target range where good shots are firing, watching the mirage through a telescope

will make one very fair at it, and a little practice will perfect one in it. One should remember that the mirage always gives the best guide to the deflecting wind, and that when the wind as estimated at the firing point apparently is contrary to the mirage, to depend always on the mirage. Mirage does not show the actual velocity of the wind, nor its exact direction. It shows from which side it is blowing, and it shows very clearly little changes in velocity and deviating power.

One precaution should be taken regarding the watching of the mirage through the telescope. The eye will have to be kept at the glass for quite a long time. If one is shooting a 20-shot match at 1000 yards, the eye will have to be at the telescope pretty constantly for almost three quarters of an hour. If the telescope be not focused exactly right a very serious eye strain may result. In focusing a telescope or field glasses, first pull the instrument out to the fullest extent of its draw, and then gradually and very slowly shove the eye-piece in, keeping the eye looking through the glass at the object all the time, and stop the instant that the image appears clear and in good focus. The telescope may appear correctly focused with a considerably shorter distance between object lens and eye-piece than this, but a shorter focus would give eye strain, and the longest draw that can be used with good focus should always be used.

CHAPTER XXXV

THE SCORE BOOK

THE rifleman can never hope to shoot well until he knows his rifle, and he can never learn it thoroughly unless he keeps a record of its shooting. He will fire at many different ranges, under many weather conditions, in several firing positions, and perhaps with different lots and makes of ammunition. No man can keep all these various elevations, windages, and zeros in his head. He must keep a record. The score book is a small book to keep this record in. There are a number of good score books on the market. Among them are the "Bull's-eye Score Book," the "Marine Corps Score Book," and the official publication for the Army entitled "Soldier's Handbook of the Rifle and Score Book." The latter is published by the Government Printing Office in two editions, one for the United States rifle, Model of 1903, and the other for the United States rifle, Model of 1917. While all these score books are intended for military rifle shooting with the military rifle, it is possible to modify them so as to make them suitable for any rifle. The score book should be carefully used, and all the various data recorded, so that at any time the rifleman may be able so to set his sights and fire that he will make a hit with the first shot.

Despite its name, the score book is not intended to keep the score alone in. In fact the book has been misnamed. It should be called the "Ballistic Record of the Rifle." The score is the least important thing to note because on all regular rifle ranges there is an official scorer at each firing point who records the official score on a score card. This score card is made out in two parts, duplicates of each other. One part is handed to the rifleman and the other portion is sent to the statistical officer for recording. The score book consists of a number of blank pages ruled and arranged for recording all the data regarding the firing at certain ranges and at certain kinds of fire. The important things to note on the appropriate page or sheet are:

1. The elevation and windage used for each shot.
2. Where each shot is called, that is where the rifleman expects it to strike the target.

3. A mark on the target diagram showing where each shot struck, that is, where it was marked.
4. The wind and weather at the time of firing each shot.
5. Any other important data such as ammunition used, temperature, position, data, location of range, light, character of target, etc.

The following instructions pertain to the use of the official score book in military shooting with the military rifle, but they may be modified in any manner desired by the civilian to suit his own particular methods of firing, and for his own rifle, always bearing in mind the general principles, and the results desired, that is, a complete record of the shooting of the rifle, including the personal equation of the man.

It will be noticed that the score book contains score sheets for each of the different classes of fire, and for each range. Samples of the various score sheets are shown herewith. Selecting the proper score sheet, just before we go to the firing point we record on it the range, the number of the rifle, the date of loading of the ammunition used (or its make and character), and the weather conditions, noting particularly the direction and approximate velocity of the wind. We then make our calculations for sight adjustment for the first shot, set our sights accordingly, and record the exact sight setting in the columns provided for that purpose. All this should be done a few minutes before it is our turn to fire.

On taking one's place at the firing point, look first to see that the wind and weather conditions have not changed.

We will now take, for example, the case of a rifleman actually firing at 500 yards with the military rifle, slow fire, on the military target B, and show how he should use and keep his score book. Follow the case carefully on the sample score sheet (Fig. 141). The rifleman, as he comes to the firing point, gives his official score sheet to the scorer, places his ammunition near his right hand where it will not get in the dirt (if it is not in his belt), and adjusts his gun-sling to his arm. He then assumes the correct firing position in a good level place at his firing point where he can see the target clearly, places his score book and pencil near his right hand where he can easily use it without moving around, and, if he is using a telescope, sets it up, focuses it, and adjusts it on the target. He has previously made the preliminary entries in the score book, so he does not have to take up valuable time to do this now. He looks, however, to see that the weather conditions, particularly the wind, have not changed since he recorded them. We are

500 AND 600 YDS. SLOW FIRE

500 Yds. Slow Fire

No. of rifle 178176 Ammunition FA 8/13/17
 Date 11/10/17 Place Camp Meade, Md.

No.	Elev.	W.G.	Wind	Call	Val.	Remarks
1	500	1-R	3/8M	•	4	
2	550	1/2 R	-	•	5	
3	-	-	-	•	5	
4	-	-	-	•	5	
5	-	-	-	•	3	
6	-	-	-	•	5	
7	-	-	-	•	5	
8	-	-	-	•	4	Wind stopped
9	-	1 R	-	•	5	
10	-	-	-	•	4	
					Score.....	45

500 Yds. Elev. correction in yards.

500 Yds. Windage correction in points.

600 Yds. Elev. correction in yards.

600 Yds. Windage correction in points.

Wind 8 miles 3 o'clock
 Light Sunny
 Weather Clear

Fig. 141
Sample score sheet

supposing that he has never fired this rifle before, therefore he has set his sights at "500" for elevation, and so recorded it. He estimates the wind at 8 miles per hour from 3 o'clock, and referring to the table of wind allowances (this table will be found in the previous chapter, and should also be contained in the score book), he sees that this will require a correction of 1 point on the rear sight for the Model 1903 rifle, or causes a deflection of 20 inches. If he is using the Model 1903 rifle he records in the column "W. G." the figures "1-R," meaning

one point right wind. If he is using the Model 1917 rifle which has no wind gauge, he records in this column the figures "20-R," meaning that he will endeavor to hold 20 inches to the right of the center of the bull's-eye. In the column for "Wind" he places the figures "3K8M," meaning 3 o'clock, 8 miles per hour. He loads his rifle and is ready for his first shot. Just as he fires it he is careful to note just where the sights were aligned on the target at the instant that the rifle was discharged. That is he "calls his shot." He records this call in the column provided for it. It will be noticed that the squares in this column have cross lines. If the shot is called a "bull," that is, if the sights were aligned absolutely correct at the instant before discharge, the rifleman simply places a dot at the intersection of the cross lines. If he calls his shot at "3 o'clock" he places the dot on the horizontal line to the right of the intersection, and so on. In this case we will say that he calls his first shot a "bull," and so records it. He now waits until the target is marked. We will say that the first shot is marked a "4" at 7:30 o'clock, just on line with the lower and left hand edges of the bull's-eye. With his sharp pencil the rifleman makes a little circle on the target diagram just where the shot was marked on the target on which he fired, and in this circle he places the figure "1" to denote just where the first shot struck the target. Now notice the correction marks on the left hand and top of the target diagram. From these it will be evident that the sight should be given 50 yards more elevation, and the wind gauge moved one-half point more to the right (or with the Model 1917 rifle aim should be taken 10 inches more to the right) in order that the next shot shall strike where it is aimed or called. Or instead of making corrections in this way the correction may be calculated from a table of sight adjustments prepared as described in a previous chapter. The rifleman makes these corrections in his sight setting and records them on the line provided for the second shot, and in the proper columns. He then glances again at the wind to see that it has not changed, and fires his second shot. This is also called a "bull" and so recorded in the "Call" column. When this shot is marked it is seen that it has struck near the center of the bull's-eye. It is so marked on the target diagram. The rifle is now sighted correctly, and the rifleman continues to fire with his sights thus adjusted, keeping an eye on the wind just before firing each shot to see that it has not changed. Everything goes all right until the fifth shot, which he accidentally pulls a little to the left, and a little high, and so records it in the "Call" column. Sure enough, when

100 Yds Slow Fire

No. of rifle _____ Ammunition _____
 Date _____ Place _____

No.	Dir.	W.G.	Wind	Call	Hit	Remarks
1						
2						
3						
4						
5						
6						
7						
8						
9						
10						

Score _____

Wind _____
 Light _____
 Weather _____

100 Yds Rapid Fire

No. of rifle _____ Ammunition _____
 Date _____ Place _____
 - Remarks -

Scoring Diagram: A diagram showing a target with a vertical line through the center and a horizontal line across the top, representing a silhouette of a target.

Aiming Point _____
 Elev. _____
 W.G. _____
 Wind _____
 Light _____
 Weather _____

Score _____

100 Yds Slow Fire

No. of rifle _____ Ammunition _____
 Date _____ Place _____

No.	Dir.	W.G.	Wind	Call	Hit	Remarks
1						
2						
3						
4						
5						
6						
7						
8						
9						
10						

Score _____

Wind _____
 Light _____
 Weather _____

100 Yds Rapid Fire

No. of rifle _____ Ammunition _____
 Date _____ Place _____
 - Remarks -

Scoring Diagram: A diagram showing a target with a vertical line through the center and a horizontal line across the top, representing a silhouette of a target.

Aiming Point _____
 Elev. _____
 W.G. _____
 Wind _____
 Light _____
 Weather _____

Score _____

Yds Slow Fire

No. of Rifle _____ Ammunition _____
 Date _____ Place _____

No.	Dir.	W.G.	Wind	Call	Hit	Remarks
1						
2						
3						
4						
5						
6						
7						
8						
9						
10						

Score _____

Wind _____
 Light _____
 Weather _____

Yds Slow Fire

No. of rifle _____ Ammunition _____
 Date _____ Place _____

No.	Dir.	W.G.	Wind	Call	Hit	Remarks
1						
2						
3						
4						
5						
6						
7						
8						
9						
10						

Score _____

Wind _____
 Light _____
 Weather _____

Fig. 142

Cuts showing the various score sheets for different classes of fire taken from the official score book in use in the United States Army. Sheets greatly reduced in size

this shot is marked it is a "three" at 10.30 o'clock. As this was the rifleman's own fault no change in the sighting of the rifle is necessary. The sixth and seventh shots are pulled correctly and result in bull's-eyes. The eighth shot, however, is a "four" to the right of the bull's-eye. The rifleman wonders at this because he called it a bull, until

he happens to notice that the wind has fallen off slightly, and is not blowing as strongly as it was. Either he failed to look at the wind before he fired, or it changed in its velocity at the instant that he fired. For his ninth shot, therefore, he brings his wind gauge back to "1-R" (one point right, or "20-R" if he is using the Model 1917 rifle). The ninth shot is another bull's-eye, but the tenth shot was called low, and strikes just below the bull's-eye.

The rifleman's total score for the ten shots at 500 yards is 45. The official score sheet, a copy of which the scorer hands to him, should read "4, 5, 5, 5, 3, 5, 5, 4, 5, 4 = 45," and the leaf in his score book should contain all the data above indicated. This leaf now gives a complete record of the rifleman, the rifle, the ammunition, and the weather, and forms the best sort of a guide for the rifleman when he comes to fire at 500 yards again, or he would refer to it for data if he is to fire at 600 yards, setting his sights just 100 yards higher. With the same rifle and ammunition he should, the next time that he is called upon to fire at 500 yards, be able to set his sights so as to strike the bull's-eye with the first shot, thus eliminating the "four" or "three" at the beginning of his score, which reduces his total score. Any rifleman will also see how important it is in game shooting to make a clean hit with the first shot. As he gains proficiency in practice the poor shots resulting from bad pulls will gradually get fewer and fewer, and he will watch the wind more closely, and not get caught by it as he was on the eighth shot in the score we have just followed so closely. He knows that with the ammunition he is using his normal elevation for 500 yards is "550" and not "500." Also that probably when there is no wind blowing he can set his wind gauge at "zero" and get a shot in a horizontal line running through the center of the bull's-eye.

The slow-fire sheets for other ranges given in Fig. 142, are used in a similar manner. The rapid-fire sheets sufficiently explain themselves. Place a small cross on or below the target diagram to show just where the aim was taken, and record this under "Aiming Point." Record in the column of remarks anything that it is desired to make record of. In recording shots on the diagram of the silhouette targets on the rapid-fire sheets simply place dots for each shot as they are marked from the butts. Notice where the "group" comes and make the necessary corrections for the next score, either in sight adjustment according to your table of sight corrections, or in the aiming point.

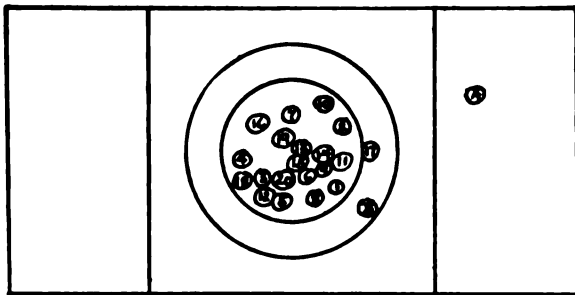

Range 1000		Yes	Date 8/17/09		Rifle 178176		Event Adjutant Sec-							
Location Camp Perry, Ohio			Time 1 a. M. S. A. M.		Amm UMC 172 gr		cants Match, O.S.R.A.							
Bar	Tem	Hwy	WIND	Dir	Force	Flag	LIGHT	Mirage	No	Elev.	WIND	Call	Score	Notes
21.15	77		11:30	E		D D			55	71	1 1/2		2	
			10:50						55		2		4	
									1	12	2 1/4		5	
						D B			2		2 1/2		5	
						D D			3		2 1/2		5	
									4				5	
									5		2 1/2		5	
			11:30						6	72.5	2 1/4		5	
						B B			7		2 1/2		5	
						D D			8				5	
									9				5	
						B B			10		2 1/4		5	
			11			D D	hand		11		2 1/2		5	16 11:30 2 1/2 5
			10:45						12		2 1/2		5	17 11:45 2 1/2 4
			11:30						13		2 1/2		5	18 11 2 1/2 5
			11						14				5	19 11:30 - 5
			11			B B			15		2 1/2		5	20 11:30 - 5
TOTAL													99	

Fig. 143

Sheet from the author's score book. Score fired in the Adjutant General's Match, Ohio State Rifle Association, 1909

Fig. 143 shows an exact copy of a score fired by the author at 1000 yards, showing all the data recorded, including the notes as to mirage flow. This sheet is shown exactly as it was made at the firing point, the only change being the inking in of the pencil notations.

CHAPTER XXXVI

MILITARY RIFLE SHOOTING

THE sole purpose of military rifle shooting is to make the soldier a good shot under war conditions. This imposes upon the military rifleman certain restrictions as to rifle and methods of fire which do not pertain with the civilian. The regulations and system governing military rifle shooting in the United States are laid down in the "Small Arms Firing Manual," United States Army, a copy of which can be had from the Superintendent of Public Documents, Washington, D. C. Following out the general scheme as laid down in this manual, the soldier should be so trained at known distances in the various kinds of fire employed in actual service as to bring his skill as a rifleman up to the capabilities of his weapon, after which he should be trained in firing as a part of a tactical unit so as to use his individual skill to the best advantage on the battle-field. The scheme of instruction is prescribed with a view to attaining these objects. By means of preliminary drills and gallery practice the soldier is trained in the fundamental principles of marksmanship; by means of range practice he is taught to apply these principles in firing at known distances at clearly defined targets. This training is merely preparatory to combat firing in which individuals learn co-operation, and company commanders and leaders learn how to obtain the maximum efficiency of fire by a judicious co-ordination of the skill and the efforts of all the individuals of the group or fire unit.

In all preliminary practice in range firing the soldier is taught to reduce the size of his shot group as much as possible, and to place the center of the shot group at the center of his target. In combat firing this principle should be utilized in securing superiority of fire. In actual combat individual targets will not, in general, be visible, but if individual shot groups be so combined as to produce a grazing fire uniformly distributed along the hostile line, a large number of hits will necessarily result, and shots which miss will have the approximate value of hits in determining superiority of fire. In a decisive battle success depends on gaining and maintaining superiority of fire. Every effort must be made to gain it early and then to keep it.

The course prescribed for the individual soldier in the "Small Arms Firing Manual" is as follows:

- (a) Nomenclature and care of the rifle.
- (b) Sighting drills.
- (c) Position and aiming drills.
- (d) Deflection and elevation correction drills.
- (e) Gallery practice.
- (f) Estimating distance drill.
- (g) Individual known distance firing, instruction practice.
- (h) Individual known distance firing, record practice.
- (i) Long distance practice (for selected shots).
- (j) Practice with telescopic sights (for selected men).
- (k) Instruction combat practice.
- (l) Combat practice.
- (m) Proficiency test in combat practice.

Soldiers are graded according to proficiency exhibited in the record practice of the known distance firing as expert riflemen, sharpshooters, marksmen, first-class men, second-class men, and unqualified.

The preliminary drills and gallery practice have remained very much the same for a number of years. In general the recruit is first taught the operation and care of his rifle, and the names of its principal parts. He is then taught how to aim, the various firing positions, and the trigger squeeze in much the manner already described in the chapters on these subjects in this work. He is then taught to co-ordinate these in position and aiming drills with empty rifle against targets made to appear similar to, and to subtend, the same visual angle as the targets which he will fire on in known distance and combat practice. During this portion of his practice he is also taught the calling of the shot, and the sight adjustment. In the firing regulations the latter is called "deflection and elevation correction drills." This instruction is then followed by gallery practice. Gallery practice is usually held at 50 or 75 feet with the .22-caliber gallery practice rifle, in the standing, kneeling, sitting, and prone positions, and a certain score in each position is required from each soldier before he is permitted to progress to known distance practice on the outdoor range. In infantry companies in the Regular Army the importance of these preliminary drills is thoroughly understood, and no man is permitted to proceed to known distance practice until he has fully mastered the fundamental principles of marksmanship. These preliminary drills usually occupy a full month, eight hours a day, in the regular army.

The prescribed course in known distance practice, or as it is also called, outdoor-range practice, has been changed from time to time, and is liable to change in the future so that it is not laid down in detail here. The reader is referred to the latest edition of the "Small



Fig. 144

Shooting with sandbag rest at the 600 yard firing point, showing coaches at work

Arms Firing Manual." In general the principles under which this course is drawn up are as follows: The soldier must first learn to shoot accurately, and also he must learn his rifle, its sight adjustment and zero at the various ranges, etc. Therefore it is prescribed that the course shall first consist of slow fire on bull's-eye targets at the various ranges. Next, having learned to shoot accurately, and having some knowledge of the elevations and zeros of his own rifle, the soldier is next introduced to silhouette targets which simulate in appearance an actual enemy. These targets are usually painted a drab or khaki color. Aiming on these is a little different from aiming at a bull's-eye, so the soldier is first given a chance to fire at them in slow fire, each shot being marked as fired. In this way he learns just where to aim at an enemy to stand the greatest chance of hitting him. Next he is taught rapid fire on these silhouette targets, being required to fire ten shots in about one minute at various ranges from 200 to 500 yards. This develops quick aiming, quick trigger squeeze, ability to operate the mechanism of the rifle quickly and certainly, and to load additional clips of cartridges surely and with dispatch, all very necessary attain-

ments of the soldier for combat practice. Having had instruction in all these, almost every shot being fired under a competent coach, the soldier progresses from instruction practice to record practice. Record practice consists of a sort of a test to determine just how much the soldier has learned in his course, and the extent of his skill with the rifle. In record practice coaching is not permitted, and the practice is conducted under all the regulations and requirements attending a regular competition. Record practice is similar to the more important portions of instruction practice, and upon the score made in it depends the final qualification of the soldier as expert rifleman, sharpshooter, marksman, etc. Following this practice certain of the best shots in each company are given additional practice at 800 and 1000 yards and also at these and longer ranges with rifles equipped with telescopic sight. This concludes the individual training of the soldier.

In order to stimulate interest in military rifle shooting throughout the country competitions in this form of shooting have been held for many years. In the Regular Army the best shots in each company compete to determine who shall represent the regiment in the division competitions. The winners at the division competitions, usually the highest 15 men, are sent to some central point for the army competitions. The 15 winning men at the army competitions comprise the army team and are sent to the national competitions. In each State there are similar competitions to determine the team which shall represent the State at the national competitions. Teams from every State in the Union, from the Infantry and Cavalry of the Regular Army, from the Marine Corps, and from the Navy are sent to the national competitions and here compete against each other for the national trophy and other prizes offered by Congress for both team and individual competitions. The National Rifle Association of America usually hold their annual individual competitions at the same time and place as the national competitions. It is here that one sees the highest development of skill in military rifle shooting. Practically all the best shots in the country are gathered together, the competition is very keen, and the shooting of a very high order. It frequently happens that even at the long range of 1000 yards a large number of competitors will attain the highest possible score, and many ties have to be shot off.

It is particularly interesting to note that at these national competitions where all the best shots of the country are brought together, that

practically every man shoots with exactly the same system, and uses the same methods. For example, if we were to take moving pictures of a number of expert riflemen in the act of shooting it would be seen that all the movements, positions, and methods would be practically identical in every respect. In other words American military riflemen



Fig. 145

View of the target range at Camp Gaillard, Panama Canal Zone, from the 600 yard firing point

have developed a system of rifle shooting that is so good that all expert shots use it, and no one has been able to improve on it for a number of years. The author has endeavored to give in these pages this system, the methods used, the manner of aiming, the various positions, the method of operating the rifle, of adjusting the sights, etc., believing that they are the best methods for any riflemen whether they are to be used for military rifle shooting, for civilian practice, or for sportsmen. No one using other methods of his own has yet been able to excel the expert who shoots according to Hoyle.

These competitions have considerable value in stimulating interest in military shooting, particularly among the civilian class. The fact, however, must not be lost sight of that military rifle shooting is intended to develop the skill of the individual man so as to make him a better shot under battle conditions. This means that the soldier must, through repetition and intelligent practice, be taught to shoot so well that even in battle, when under intense excitement and exertion, he

will shoot well as second nature. It means that he must be trained so that he will never fail to adjust the sights accurately at the range ordered, so that he will never fail to aim accurately at the target ordered, so that he will never fail to squeeze his trigger carefully without the least suspicion of a jerk. All this takes time, repetition, practice. Many a man has gone through a season's course and made



Fig. 146

Shooting at 600 yards. Camp Gaillard, Panama Canal Zone

a fine score because of his natural talents, but he is far from being a trained military shot — he would go all to pieces under excitement.

In military rifle shooting the rifle must be used as issued to troops. It is permitted to blacken the sights, or to ease up on the wood under the upper band if it binds the barrel here and interferes with its free expansion when heated. The trigger pull must be at least three pounds. The United States magazine rifle, model of 1898, now being obsolete, the only arms permitted in regular military shooting are the United States rifles, Models of 1903 and 1917. In competitions it is usually permissible to use a micrometer sight adjuster for adjusting the rear sight of the Model 1903 rifle. The use of score books and field glasses, or small portable telescopes such as could reasonably be carried by the soldier, is always permitted and encouraged. Soldiers must shoot in the regular service uniform, either with blouse or O. D. shirt, and with the regular cartridge belt. In certain combat exercises the full pack may be required.



Fig. 147
The 300 yard firing point at the Plattsburg Training Camp, 1916

The recruit will almost always have a good coach to take him through his first year's practice up to his record practice. Army regulations make the company commander responsible for the instruction of his company in rifle firing, and this matter of instruction of the new men will always be taken care of in organizations. The civilian who desires to take up military rifle shooting is strongly ad-

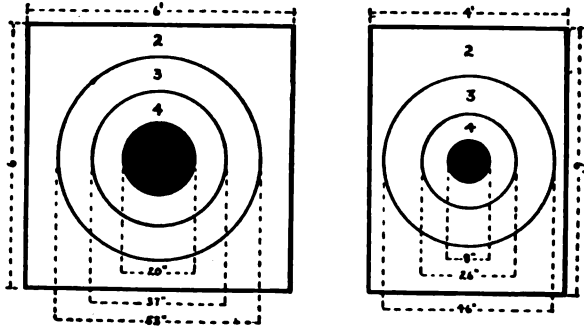

TARGET "B"
200 & 300 YARDS.

TARGET "A"
200 & 300 YARDS.

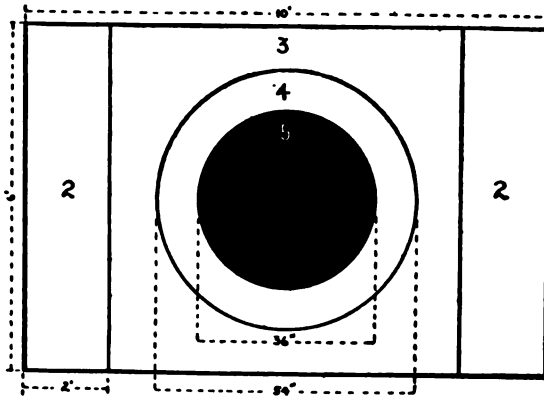

Target C—800 and 1000 yards
Targets used in military rifle shooting. Slow fire

vised to join one of the civilian rifle clubs organized in connection with the National Rifle Association, where he will always find fellow members only too willing to coach him and steer him over the rough places. In joining such a club he also gains the advantage of having a government rifle for use, and of getting a certain amount of ammunition free, and anything over this at cost price.

Military rifle shooting is good sport. Almost every one who goes into it to any extent becomes very enthusiastic about it. It offers many returns too. The rifleman who is successful in his organization usually has a chance to go to one of the smaller competitions. Success there means a State or divisional competition, and from there to the national competitions which usually take about two weeks to compete. Very often international competitions are arranged, and our teams have often gone abroad and even to South America to compete with foreign teams. The sport is a clean, healthy one, there is no taint of commercialism to it, and the rifleman has the satisfaction of knowing that he is excelling in something that will be of direct benefit to himself and to his country.

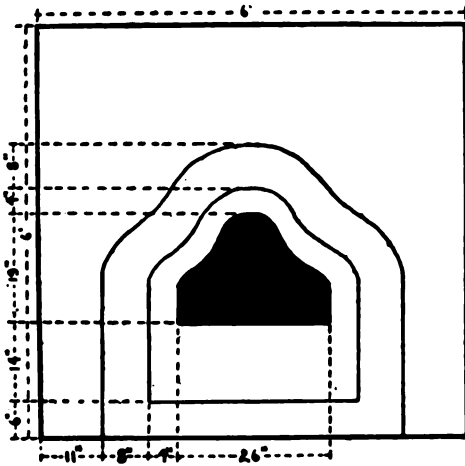

TARGET "D"

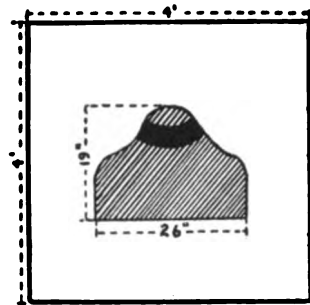

TARGET "O"

SILHOUETTE OLIVE DRAB COLOR WITH RED FACE.

Targets used in military rifle shooting. Rapid fire

CHAPTER XXXVII

TEAM SHOOTING

THE principal event in rifle competitions in the United States is the national matches which have been held annually. These matches are authorized, and the trophies are awarded by Congress. In these matches teams from the National Guard of every State in the Union, from the Army, Navy, and Marine Corps compete in team matches, and the individuals of the teams also compete in individual matches. Usually the annual matches of the National Rifle Association are held at the same place as the national matches, and immediately precede or follow those matches. The national matches have therefore become the Mecca for the riflemen of the United States, and the competition for places on one of the teams to visit these matches is very keen, as are also the competitions themselves. The principal one of the national matches is the National Team Match in which compete teams from all States, one from the Infantry of the Regular Army, and one from the Cavalry, one from the Navy, and one from the Marine Corps. The team making the highest score in this match wins the team championship of the United States for that year, the national trophy offered by Congress, and a medal for each member of the team. Teams consist of twelve shooting members, three alternates, a team captain, coach, and spotter.

In the National Guard the national match team is usually selected by a very thorough series of competitions within the State. Usually these competitions start in the companies, the men of each company competing for places on the company team. Company teams compete for the championship of the regiment, and from the men so competing the best are chosen for the regimental team. The regimental teams usually then compete in a state competition, and in that competition the best shots are picked to represent the State at the national matches. In the Army, Navy, and Marine Corps a slightly different method of selection usually pertains, a number of men with excellent past record as good shots being gathered together early in the spring, and the team selected from them by a very thorough try out. The competition for places on these teams is so keen, and such a high order of marks-

manship is necessary that we find men training for these teams all winter in gallery practice, and shooting on the outdoor range practically all summer.

An enormous amount of time and thought has been expended on the training of these teams, and a number of systems have evolved, but as far as known none of them have been described on paper for the benefit of teams and riflemen at large. These systems have been rather regarded as secrets, this having been brought about by the keen competition. The author was a member of the United States Army Infantry National Match Team in the years 1903, 1905, 1906, 1907, and 1909, and presents herewith the system finally developed in that team as the best, a system which has resulted in the team making the best all around record of any competing team.

There is a system of rifle competitions in the Regular Army which is intended to develop expert shots skilled in all the refinements and niceties of the game, who, upon their return from competitions, will be the better trained to coach the men of their companies or troops to a higher order of marksmanship. Thus the best shot from each company and troop, as developed in the regular practice of the organization, is sent to a rifle competition held in the department where his organization is serving. Here all the representatives compete in an individual competition lasting about six days, and the highest twelve men are sent to the army competitions where they compete for twelve places on the army team. This team itself has no connection whatever with the national matches, neither does it ever shoot as a team, it being simply the aggregation of the twelve highest men in the army rifle competition, although as a matter of fact these men are usually sent to the national matches to compete merely as individual shots and not as a team. From these competitions held annually or semi-annually in the Army it is possible to pick a number of very excellent rifle shots on their past records.

In January of each year the team captain for the Army Infantry National Match Team is chosen by the War Department, and detailed on this duty, being a senior officer of long and successful experience in team shooting. The captain selects, from their previous records as riflemen, about forty of the best shots in the Infantry who are available, and warns these men that they will be ordered some time in May to some previously designated rifle range to compete for places on the team. The men are advised to start training and practice at once, and to give up smoking. Almost invariably these men start in

with a strenuous program of shooting and physical training. If the army post at which they are stationed does not permit of outdoor shooting the man most probably starts in with gallery practice until such a time as the weather permits him to get on the outdoor range. By the time that May comes the candidates are all in fine shooting form, their muscles and eyes are trained, and their nerves are in first-class shape.

About the middle of May these men are all assembled, usually at an army post where there is a first-class rifle range, for their training and for the competition. The team captain has also gathered together all the material for the team, the following list showing about what will be needed.

- 2 rifles, star gauged, .308-inch groove diameter for every man competing.
- 30 rifles, star gauged, .308-inch groove diameter for the team to be finally selected.
- 1 barrack cleaning rod, steel, for each man.
- 12 telescopes, individual, 33 diameter.
- 12 telescope rests for individual telescopes.
- 1 telescope, large, with tripod, 60 diameters.
- 1 micrometer sight adjuster for each man.
- 4 score books for each man.
- Sperm oil.
- Cosmic grease.
- Aqua ammonia, 28 per cent. gas.
- Ammonia persulphate.
- Ammonia carbonate.
- Cut flannel patches.
- Targets and target material.
- Ammunition.

} Sufficient quantity for competition and training.

Each candidate is issued two rifles with instructions to use one for slow fire work only, and the other for rapid fire. He also receives a cleaning rod, micrometer sight adjuster, score book, and cleaning material. A telescope and rest are provided for him at the firing point. His name is placed on a box of ammunition and he obtains his cartridges from that box only, thus assuring that his ammunition is always from one lot. The other material and equipment he has to supply himself.

The first two or three days of work on the range are used in getting

these rifles sighted in at the various ranges. The team captain then starts a competition which has usually consisted of shooting six times through the national match course. This course differs from year to year, and is prescribed in general orders from the War Department. Of late years it has usually consisted of 10 shots slow fire at short, mid, and long ranges, and rapid or surprise fire at short range. While this competition is conducted in strict accordance with all the rules governing competitions (see "Small Arms Firing Manual") yet the competitors are permitted and encouraged to coach each other. Two competitors are usually paired together and shoot together all during the competition. The captain thus not only knows the shooting ability of each man, but gets a good line on his ability as a coach, and on his suitability as a team member. This competition usually requires about a month for its completion, and at the end of that time the fifteen highest men are chosen from the 12 shooting members of the team and the three alternates, and the remaining competitors are ordered back to their stations.

The team is then organized and starts in to practice as a team. A shooting order is tentatively determined upon. Men who get along well together are usually paired together, taking care that each pair shall include at least one good coach. It is very important that the first pair to shoot shall include excellent shots because a good start in a match raises the morale of the team, and the other pairs are liable to start off with a rush. The last pair to shoot should be the oldest, and particularly the most reliable and steady men who are not liable to become excited if it requires a bull's-eye on the last shot to win the match. Competition is so close in these matches that the match is frequently not won until the last shot. It should be understood that in a team match each team is assigned to one target, and that they shoot on this target in pairs, two men in a pair, the man on the right shooting first, and the pair alternating shots. Thus a team of twelve men contains six pairs.

In this team practice much attention is paid to the correct keeping of scores in the score books. Everything is recorded, particularly on days when the weather conditions differ from normal. The various elevations and windages required with each rifle are compared, so that when one man succeeds in hitting the bull's-eye every man will know just how to set his sights to accomplish the same thing. The whole object is to make as high a score as possible for the team, and not for any individual to make a phenomenally high score. To this

end each member tries to coach his partner to as high a score as possible, at the same time trying to do the best he can himself. In this training the shooting usually consists in firing a number of times through the national match course, although the captain will often have the team shoot extra scores at the most difficult ranges, and at those ranges and classes of fire in which they appear to be weak. About three weeks before leaving the rifle range where the teams have been training for the range where the national competitions are to be held the team will be issued their new rifles, two to each man, and thereafter all practice will be held with these new rifles, so that the rifle of every man will be in its very best shooting condition at the time of the match. A United States rifle, Model of 1903, probably shoots at its very best from its one hundredth to its eight hundredth round, although some rifles will continue to do splendid work for a long time after this.

All this time the team is getting shaken down, trained, and becoming skilled so that they can put through an exceptionally good score in any weather condition. Care must be taken not to do too much shooting or there is liability of the team getting stale. An occasional holiday when there is some form of healthy amusement going on in the vicinity is a mighty good thing. Holidays had better come when the weather conditions are normal, and advantage be taken of abnormal days to do quite a lot of shooting so as to thoroughly learn the dope for such days.

In the conduct of the team practice certain things are insisted on:

Every team member must do his best to assist his partner, and the other members of the team, and never intentionally lead them astray. Thus men have been thrown off the team for telling their partner that they pulled a certain shot at 5 o'clock when as a matter of fact they knew that they had pulled it dead at 6 o'clock. Such a man has no place on a team.

Elevations are always recorded in minutes on the micrometer sight adjuster, and not in yards.

In slow fire, when one member of a pair is firing the other member must have his eye at the telescope. Thus he catches any shot which happens to go low and kick up dirt on the butt, or any change in the drift of the mirage.

Each man must shoot "according to Hoyle." Such methods as holding off for wind or elevation instead of correcting the sight adjustment, or of using peculiar positions, or crank methods of adjust-

ing the gun-sling are not tolerated. Drinking and smoking are not permitted. Men must shoot in the service uniform, with either blouse or shirt. Belts must be worn.

Each man must have his sights blackened, his sling adjusted, and his sight set before he comes to the firing point so as not to waste valuable time.

Score books are always open to the inspection of the team captain and to the man's partner. A uniform system of keeping score books is required.

The very best care must be taken of the rifles so that they will do their best work all the time. Members of the team are required to clean their rifles, using the regular metal fouling solution, every afternoon before supper. The rifle must be regularly "doped" so as to render the bore chemically clean, as it has been found that rifles cleaned in this manner every day shoot their best, and maintain their accuracy the longest. Some members occasionally clean their rifles in this manner at noon if they have been doing much shooting, but the experience has been that this is hardly ever necessary.

The team is usually ordered to the range where the national match is to be held a week or two before the date for the opening of the matches in order to enable the men to get settled, accustomed to the change in locality, water, etc., and also so that they can get a little practice on the range and become accustomed to the conditions before the matches start. Here the men are camped together, and are messed together. They are required to retire by ten o'clock every night, and in every way their living is made as uniform and healthy as possible. The men's eyes particularly must be watched. They must not be allowed to watch the targets except when they are actually firing or coaching, and they must not read by artificial light or when lying down.

The period of team training is now at an end. Everything has been done that was possible to bring up their aggregate shooting ability. Not only has every man had the advantage of the coaching by his partner, himself in all probability an expert shot, but the team coach, picked as the most experienced rifleman in the whole Army who is available, has done his best to work each man up to the limit of his ability. To show the skill demanded in team shooting of this order, it has been demonstrated that a man is of little use on one of the top teams unless he can shoot right along under almost any weather conditions and average scores as follows:

200 yards offhand	44 points out of 50
600 yards slow fire	48 points out of 50
800 yards slow fire	49 points out of 50
1000 yards slow fire	43 points out of 50
200 yards rapid fire	48 points out of 50
300 yards rapid fire	46 points out of 50

Several days before the date set for the commencement of the National Team Match the names of the twelve men who are actually to shoot in the match are made public. Ordinarily these will be the twelve regular shooting members of the team, although if any one of these is not shooting in good form, or is not physically in good shape, the team captain will not hesitate to put in one of the alternates instead. Thus no alternate knows until the end whether he will have a chance to shoot on the team or not, and no shooting member is absolutely assured of his chance to shoot. This keeps every one keyed up to do his best all the time in practice as well as competition.

On the day of the match the shooting members of the team are not allowed to come to the firing point until just before it is their turn to fire, and they are not permitted to know the scores made by members who precede them until the end of the day's shooting. Also they are told to keep away from all bulletin boards, etc. Thus the members escape all the nerve-racking excitement which is always present at the firing point. At the proper time, when warned by the team spotter, they slowly wander out from camp to the firing point, taking with them their rifle and equipment, and sit down quietly in rear of the firing point, having only about five minutes to wait until it comes their turn to fire. Each man should thus be able to shoot at his very best. After each day's shooting the team captain gives his team a talk, calling their attention to what has been done so far, what remains to be done, and the plans for the next day. The men are encouraged as much as possible, and should be kept away from competitors of the other teams as far as it can be done. Thus everything is subordinated to the one idea of winning the match, of having every man make the best score he is capable of, both for himself, and for his shooting partner. The whole spirit must be **TEAM WORK**.

CHAPTER XXXVIII

REST SHOOTING AND TESTING

MACHINE rests and muzzle and elbow rests for the purpose of steadying the rifle during aiming and firing have always been used by small arms factories and arsenals for the purpose of eliminating the human error as far as possible when testing arms and ammunition for accuracy and suitability for use. Individual riflemen have also often used a rest to shoot from when aligning sights, and to test the accuracy of ammunition, and at one time there was a small coterie of riflemen in the Massachusetts Rifle Association who indulged in 200-yard competitive rest shooting at the old Walnut Hill rifle range. But the number of men who have utilized rest shooting for the purpose of conducting a serious study of the rifle and its ammunition, and the ballistics of small arms in general, can almost be counted on the fingers of one hand. And yet I know of nothing else which will so thoroughly teach the science of rifle shooting and rifle ballistics, and so clearly demonstrate the truth or fiction of theories as carefully conducted rest shooting. Individual rifle shooting of the ordinary kind without competition becomes monotonous after a time. One progresses quickly in skill at first, but when he reaches a certain stage further progress comes very slowly. But rest shooting is always interesting. There is no limit to the number of experiments that can be conducted, and there is a constant chance for improvement in methods and material. It is the most interesting kind of solitaire with the rifle.

I think that Mr. E. A. Leopold of Norristown, Pennsylvania, can be regarded as the originator of the intensive study of the rifle and its ammunition by means of firing from rest. It was he who called to the attention of Dr. F. W. Mann the method of investigating the flight of the bullet by means of tipping bullets fired through paper screens. Dr. Mann spent practically a lifetime in experimental work of this nature, and the results of these experiments up to the year 1909 are set forth in his book "The Bullet's Flight." From 1909 to his death in 1916 Dr. Mann devoted practically all his time to further studies of rifle ballistics, and accomplished wonders in these lines,

developing methods which led to an increase in accuracy and velocity above anything that heretofore had been deemed possible. He had just started to compile the results of these latter experiments in a second book when all the work was halted by his sudden death. A large amount of the results of his investigations are incorporated in this work, particularly in Chapter XVII. The riflemen of the world, and science in general, suffered a severe loss when Dr. Mann passed away. Both Mr. Leopold and Dr. Mann were years ahead of their time in their knowledge of rifle ballistics, and to this day science in general, and the various manufacturers and ordnance offices, are just

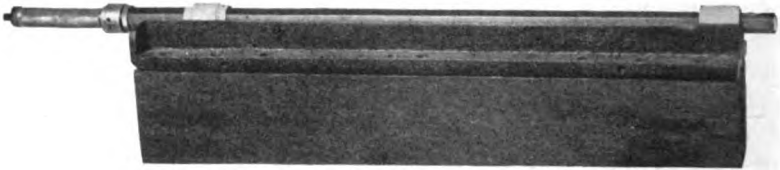

Fig. 148

Mann "V" rest with barrel in position for testing, showing action and rings

learning facts which these two riflemen discovered years ago, due almost entirely to their methods of study; that is, intelligent rest shooting.

The range on which Dr. Mann conducted his experiments is an object lesson in itself. There is none other like it in the world. It was built on his homestead farm near Milford, Massachusetts. The range was 200 yards long, but bullets could be fired up to 400 yards. For 200 yards the range was entirely covered and protected by a long gallery made of wood, with a shooting house at one end. In this long gallery arrangements were introduced so that paper screens could be quickly and accurately set up at any distance up to 6 inches apart for the entire range, for the purpose of accurately tracing the flight of each bullet. All firing was done from what Dr. Mann called a "V rest." This was a "v"-shaped trough, 30 inches long, and made with absolute accuracy of fine bronze, and weighed 33 pounds. The barrel lay in it in concentric rings, and the stock and action were always removed and replaced with a concentric action screwed on to the rear of the barrel. Thus when the barrel was fired it recoiled straight to the rear, sliding through the "V," and there was not the slightest whip or buckle. For every shot the barrel lay with the axis of its bore absolutely accurately aligned on a point on the 200-yard target, and a corresponding point on all intervening screens, known

as the "tack hole," so that the line of fire was absolutely uniform from shot to shot, and from year to year. This bronze "V" rest was bolted to a cast iron slab, 16 inches wide and 36 inches long, weighing 180 pounds. This slab rested on a cement pier, and was fastened by 6 stay bolts reaching down 16 inches into the concrete. The foundation of this shooting Gibraltar were 2 feet wide, 5 feet long, and reached down several inches into bed rock. The whole structure weighed a little short of 3 tons, and in all the years of its use there was no movement in it at all. As Dr. Mann used to say, this "V" rest always told the truth.

It is not possible for us to construct such ranges in these days,

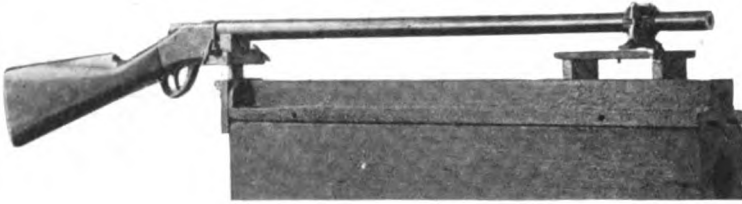

Fig. 149

Machine rest used on top of a Mann "V" rest. Sharp rifle in position for testing and indeed it would take almost a lifetime of study before one would be competent to conduct experiments thereon which would require so much accuracy that they could not be conducted as easily, and at much less expense on a more modest muzzle and elbow rest.

With a view to learning the truth as regards certain beliefs and statements of riflemen throughout the world, and also in order to conduct certain experiments which I had always desired to put through, about ten years ago I started rest shooting in a modest way, but it was not until I became associated with Dr. Mann in his work that I learned the capabilities and technique of rest shooting. The instructions and suggestions given herewith are based on four years experimenting on my own rest and range (which, although very modest in character, proved very efficient), and on writings, experiments, and suggestions of Dr. Mann.

When we take up rest shooting for the purpose of test and study our first effort must be directed towards eliminating the human element and error as far as possible from the shooting. In the results there should stand forth only the error of the rifle and ammunition. The first consideration therefore is the construction of the rest. There are two general types of rest: the machine rest in which the rifle is

firmly held in clamps, and slides on a track when it recoils on firing; and the muzzle and elbow rest in which the rifleman holds the rifle himself, seated at a very firm table, with the muzzle resting on a block, butt against the shoulder, and toe of the stock resting in the left hand which in turn is rested on the table. There has been considerable discussion as to the relative value of the two types of rest, many claiming that the muzzle and elbow rest does not eliminate the human error. Personally I have always used the muzzle and elbow rest, and the results which I have obtained approximate so closely to the results obtained by Dr. Mann on his "V" rest that I am convinced that for all practical purposes the human error has been eliminated in my case, but it undoubtedly takes considerable practice in rest shooting



Fig. 150

Same rest as shown in Fig. 149 used in testing a pistol

with such a rest before one can be positively certain that the line of fire is absolutely constant from shot to shot through a long series. The advantages that the muzzle and elbow rest has over the machine rest are cheapness of construction, and adaptability to any rifle without adjustment. Before a rifle can be used in a machine rest the forearm must be removed, and rings must be milled accurately for the barrel so that it can be clamped securely in the two mountings. With the muzzle and elbow rest it is possible to approximate very closely the conditions which pertain in shooting offhand by resting the forearm only on the rest, and padding the rest with a blanket; but with the machine rest the rifle shoots very differently from what it does when fired offhand. Many riflemen have stated that an expert rifleman can always equal or exceed the work of the machine rest. I do

not know what they base their statement on, because a correctly adjusted and used machine rest certainly does eliminate all human error, and the known human error is present in all offhand and prone work. The machine rest is undoubtedly the best, especially for a man not particularly skilled in rest shooting, but when one has a large number



Fig. 151

Mr. Edward C. Crossman shooting from an extemporized muzzle and elbow rest of rifles to test, as was my case, the muzzle and elbow rest is very much more convenient.

As stated, a muzzle and elbow rest for serious work should consist of a very heavy and secure table placed at the firing point. The table must be absolutely immovable. In my case I used a heavy concrete pier to the top of which was bolted a top of 3-inch plank, and the planks could not be moved or shaken at all. The same security can be accomplished by a table constructed with five legs composed of timbers 6 inches square sunk at least two feet into the earth, and a top of planks at least two inches thick. The design and dimensions of this table are clearly shown in Fig. 152. The top of the table should be about four to six inches higher than a regular table top if one is going to use a regular height chair to shoot from. Instead of having the muzzle or forearm rest firmly fastened to the

table I found it more convenient to make it with a large box base. This box was then filled with scrap iron to weight it down, and it then stayed practically immovable wherever it was placed on the table. Thus I was able to push the muzzle rest out on the table so that the rifle would rest on it at the muzzle, or I could pull it back slightly towards the rear and use it for a forearm rest. The height of the muzzle rest above the table must be determined experimentally, aiming the rifle at the target, and using that height which will give the best and steadiest position of the rifle, elbows, and hands. If the target at the butts be on the same level as the table this height will be about 10 inches.

The rifleman sits on a heavy chair on the left side (facing the target) of the table, and near its rear end, left side towards the target, muzzle or forearm of the rifle resting in the muzzle rest, right hand grasping the small of the stock, breast leaning against the edge of the table so as to make the body steady, butt of the rifle against the shoulder or right upper arm, left hand under the toe of the butt, and grasping the lower portion of the butt-plate. Elevation is secured by humping up, or flattening out the left hand a little as it rests on top of the table and grasps the toe of the stock, and if necessary small planks of wood can be placed on the table under the left hand to build it up more and thus depress the muzzle of the rifle for a lower shot. The rifle is traversed to the right or left by moving the right shoulder to the right or left. If the rest be made to fit one, and a little practice be had in this position, one will very soon come to a realization that he can hold absolutely steady. Accurate use of the rest consists not only in holding steadily, and aiming accurately for each shot, but also of holding exactly the same each time. Each hand must be in exactly the same position for each shot, must hold with exactly the same tension, and the rifle must be held to the right shoulder in the same place and with the same tension. The muzzle or forearm must be rested at exactly the same place each time, and must bear down on the muzzle rest with the same weight for each shot. After you have become accustomed to shooting in this way you can amuse yourself by adopting different positions, or different tensions in your holding, and watching the point of impact on the target vary as you do so. This is one of the beauties of rest shooting, you prove everything for yourself as you go along, and prove it to your absolute satisfaction.

Certain accessories are very desirable with the rest. A high power

telescope fastened to the left edge of the table, set in a rest of its own, and trained and focused on the target, so that when one is shooting the target can be inspected at any time by simply leaning a little to the left and forward, is almost an absolute necessity. One can see then from shot to shot exactly what he is doing. A 33-power telescope is good enough for 100 yards range, but to see bullet holes clearly in the black bull's-eye at 200 yards a clear glass of almost 60

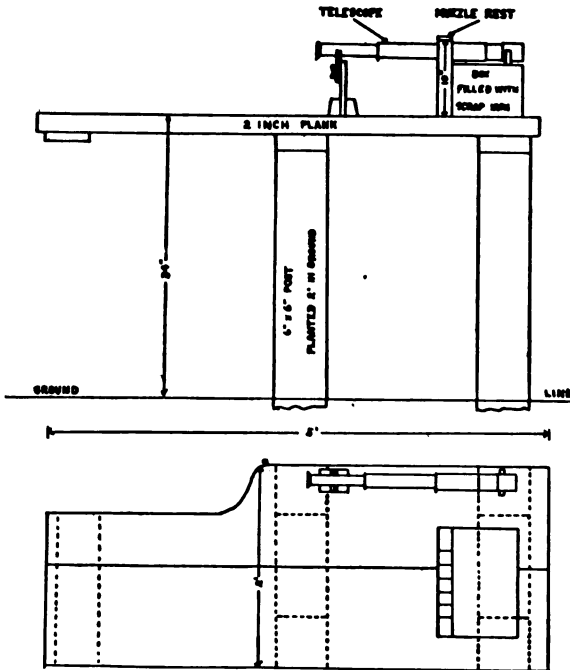

Fig. 152
 Details of muzzle and elbow rest table. Side and top views

diameters is essential. There should be some kind of a wind and light screen, as the rifleman must be sheltered from the wind or he cannot hold steadily, and his sights must always have a uniform appearance, which means that they must always be in the shade. By far the best arrangement is to build a little house around the rest table. Only a small hole is necessary in front of the table to shoot through, and another small port for the telescope. In fact the cutting off of light from the front will permit metallic sights to appear as a silhouette against the target and hence they can be seen much

more clearly and aligned with greater accuracy. The house should be lighted by one window on the back side. The floor should be built around the table and its legs so that the table is not touched at all by the building. Thus any tremor of the house or floor is not transmitted to the table. My own shooting house was thus built, many conveniences such as rifle racks, cleaning bench, shelves, and a stove for cold weather were arranged, and the whole thing constructed of scrap lumber and tar paper at a cost of less than \$35. If I were building another one I would build it exactly the same. Gradually there developed a confidence in this range and the results obtained at it which nothing can shake.

It is very desirable that the range itself should be on absolutely level ground. Thus targets can be easily arranged for any range, and the erection of screens in the line of fire will not be difficult. A distance of 200 yards is as long as is necessary, and even that distance will seldom be used except for trajectory tests. Most of the experimental work will be conducted at 100 yards. At this range results can be compared as well as at longer ranges. All inaccuracies

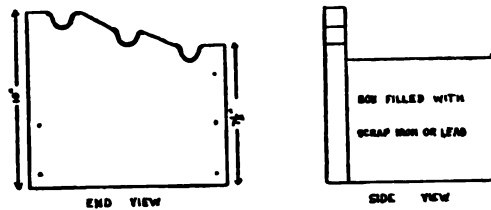

Fig. 153

Details of muzzle rest. This is placed on top of the forward edge of the table, and can be moved around where desired, its weight keeping it in place. The notches at varying heights for barrel or forearm of the rifle should be lined with heavy felt padding

will show up as clearly at 100 yards as at longer distances. With a range of only 100 yards it does not take long to go down to the butt and inspect or change the target, and the telescope of 33 diameters for examining the target from the firing point is not an expensive affair, whereas the 60-power telescope required for really accurate observation at 200 yards costs a large sum. Practically all of my work was done at 100 yards, as will practically all of the work of other experimenters.

Now that we have our range built, what are we going to use it for? Some of the uses to which it can be put, and some of the first experi-

ments which the novice would do well to conduct, are as follows: One may test an unknown rifle and ammunition for accuracy, and align the sights accurately. This is the most common use of the muzzle and elbow rest. One may test a certain lot of ammunition in a rifle of known accuracy, or an unknown rifle with a known lot of ammunition. The proof of the pudding is in the size of the group. Test for the effect of using Mobilubricant on the bullets. Determine the result of firing the first shot with a clean, oily bore; a clean, dry bore; and a fouled bore. Does the rifle shoot higher as it gets hot from firing? What is the effect on the point of impact of resting the rifle at various points on the barrel and forearm, and of various substances used as rests? Shoot the rifle with the barrel rested at the muzzle on a hard plank, and with the forearm rested on a thickly folded blanket, and notice the difference in where the group comes on the target, sights and aiming point remaining the same. Keep a record of thermometer and barometer from day to day, and notice the effect on the point of impact. Determine by a trajectory test on various days whether this is due to velocity or to barrel condition. Conduct a trajectory test with intermediate screens to determine the exact trajectory of various loads over 100 or 200 yards. Deform the base of the bullets by beveling the base so as to unbalance them, shoot through special paper screens, and by means of the tip of the bullet in the various screens study the bullet's flight, its gyrations and oscillations. Work out various reduced loads, and determine the difference in point of impact between them and the full charge, and calculate and verify the different sight adjustment required. In the above tests alone there is enough work to keep one rifleman busy with one rifle for every Saturday afternoon for a year. There is no limit to the number of experiments that can be conducted, and with each experiment completed the rifleman has gained added knowledge of his arm and of ballistics, and has verified something to his complete satisfaction.

In the various tests and experiments the rifleman's ingenuity should be given full opportunity. One experiment will usually suggest another. All work should be carefully tabulated and accurately kept. The value of any test or experiment depends upon the accuracy with which it was conducted, and the attention paid to minute details. To this end quite a number of articles and tools are essential. One must have complete sets of reloading tools, scales for weighing powder charges, a supply of the various powders, gas or oil stove and outfit

for moulding bullets, telescopes, micrometer calipers, etc. A small machine shop is very useful, but I have always managed to get along with a few files, vise, whetstone, screw-drivers, drifts, hammer, anvil, etc. In fact when doing most of my experimenting my entire shop for reloading ammunition, making repairs, alterations, etc., was contained in a closet 5 feet square in which I did all my work preparatory to a visit to the range.

The following tests will give the rifleman an idea of some of the work that can be done on a rifle range equipped with a machine rest or a muzzle and elbow rest. As I have said one test and experiment leads to another, and the rifleman soon finds that he is started on a most interesting game, and one which will tax all his resources and brain.

Test 1. Let us say that the subject of our test is a small bore, high-power rifle equipped with sights which will adjust for both elevation and windage to minutes of angle. We will first sight the rifle in at 50 yards to strike in the center of a 3-inch bull's-eye when the sights are aligned at the lower edge of the bull's-eye. After having the sights adjusted to our satisfaction for the regular high-power ammunition, let us fire a group of 10 shots with this ammunition at 50 yards. Note the size of the group and the center of impact as described in Chapter XXI. Now load up a reduced load (attention is called to the data on reduced loads in Chapter XI), and test this load also at 50 yards, using however the same target that you fired on with the full charge, and having the sights adjusted with the correct elevation and windage for the full charge. Be sure to clean the rifle after using the full charge and before using reduced charge as the reduced charge will not shoot accurately in a barrel containing the fouling of the full charge. (Try it and see if it will.) Now you have two groups on your paper target, one fired with full charge, and the other with reduced load, but both fired under the same conditions, and with the same sight adjustment and point of aim. Note the distance in inches between the two. The reduced load will probably strike a few inches lower on the target than did the full charge, and perhaps a little to one side. If the reduced load center of impact is 5 inches below, and 1 inch to the right of the center of impact, then the correct sight adjustment for the reduced load should be 5 minutes higher, and 1 minute to the left of the full load sight adjustment. Change the sight adjustment accordingly, and fire another group with the reduced charge and see if it strikes fairly near the center of the

bull. Now one has the sight adjustment for both full charge and reduced loads at 50 yards, has demonstrated how far apart they will strike on the target with the same sight adjustment, and also has a line on the accuracy of both loads at 50 yards. As regards accuracy, one must remember that the error of aim at 50 yards with metallic sights is about half an inch, but that if a telescope sight is used on the rifle this half inch error must be divided roughly by the power of the telescope. Thus with a five-power telescope this error should be only about $\frac{1}{10}$ inch. If you have a rifle which is sighted with both metallic sights and telescope, try this out. Shoot 10 groups with metallic sights, and then 10 groups with telescope sight under exactly

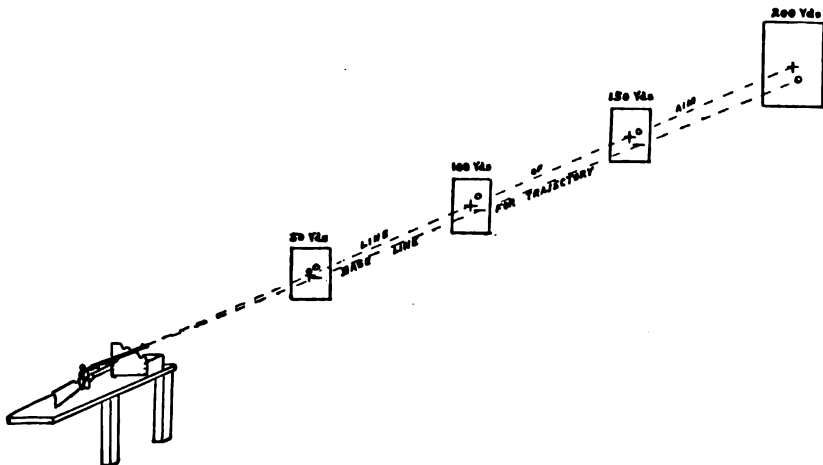

Fig. 154

Showing arrangement of screens, cross lines, and base lines for trajectory as arranged for trajectory test. The small circle indicates the bullet hole through the screens and target, the cross shows the cross lines which form a straight line from muzzle to target, and the small horizontal line is the base line from which the height of trajectory is measured

the same conditions, and see whether the average of groups is about $\frac{1}{10}$ inch in favor of the telescope.

Test 2. Find the correct sight adjustment for each load up to the limit of your range, and also make an accuracy test at each range to determine the capabilities of the rifle and cartridge at that range. In making an accuracy test do not put too much faith on one group of 10 shots. It may be a lucky group. In making accuracy tests I always tried to fire at least 10 groups of 10 shots each, and then average the result. Let us say that in thus testing out a load at various ranges you find that the sight elevation required for 200

yards is 2.75 minutes above that required for 100 yards. In each case you have carefully measured the centers of impact to arrive at this close figure. This will show that the height of the trajectory of this load at 100 yards, when shooting at 200 yards, is very close to 2.75 inches, although trajectory cannot be determined accurately in this way, but should be determined by a regular trajectory test as described below.

Test 3. Suppose you wish to accurately determine the trajectory of a certain load over a range of 200 yards. Let us determine the height of bullet at 50, 100, and 200 yards. First erect frames for paper screens in the line of fire at exactly 50, 100, and 200 yards, but do not place the screens in position yet. Place a high power telescopic sight, or the telescope of a transit on the rest so that it will assume the same position as the barrel of the rifle does when fired. Shim up the telescope until the cross-hairs assume the same position on the rest that the axis of the bore of the rifle will. Align this telescope on the center of the 200-yard target and make a cross on the target where the intersection of the cross-hairs come. Now be very careful not to move the telescope until we are through aligning and marking the screens. On your framework at 150 yards place your screen of thin writing paper and looking through the telescope make a cross on this paper where the cross-hairs intersect. Similarly insert the screens at 100 and at 50 yards, and with the telescope place cross lines on them where the cross-hairs intersect. Now these four cross lines on the 200-yard target and on the intermediate screens will be exactly in line with each other, and with the cross wires of the telescope, or the axis of bore of the rifle when it replaces the telescope on the rest. On the 50-yard screen paste a 3-inch black paster about half an inch directly above the intersection of the cross lines as an aiming point. Now remove the telescope from the rest, and place the rifle thereon, sights adjusted for 200 yards. Aim at the small bull's-eye on the 50-yard screen and fire one shot. Leave the screens alone for the present. Go to the 200-yard target and note how much above or below the cross lines on that target the bullet struck. Make your measurements with a carefully graduated rule. I have always used an engineer's triangular boxwood rule. This measurement gives you the base line from which the trajectory must be calculated. If the bullet has struck 6 inches below the cross lines on the 200-yard target the base line for trajectory must be ruled horizontally on each screen,

on the 150-yard screen 4.5 inches below the cross lines, on the 100-yard screen 3 inches below the cross lines, and on the 50-yard screen 1.5 inches below the cross lines. The distance from this base line for trajectory to the center of the bullet hole through the screen will be the height of trajectory at the distance at which the screen was placed. Fig. 154 explains this very clearly.

If much work be done in trajectory tests it is best to plant two heavy posts in position where each screen comes, and fix to them a cross piece, exactly horizontal and about 2 feet below the cross on the paper. When the screens are first set up, and the cross marked on them, drop a perpendicular with string and plumb bob from the

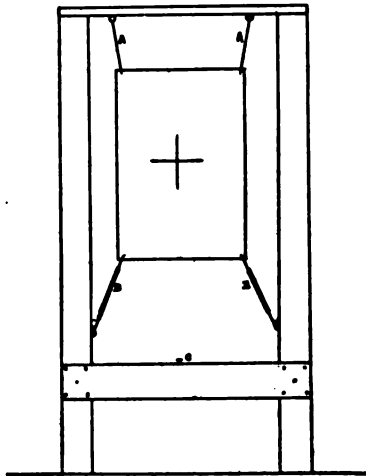

Fig. 155

Posts and frame for supporting screens. Screens are supported above by two cords carrying hooks inserted in holes punched in the corners of the paper; and below are held taut by rubber bands B-B, and similar hooks to those above. Cross on screen is drawn at a determined distance measured perpendicularly from the top of the tack C on the lower cross-piece

cross on the screen to the cross-piece below, and drive a nail at the point of the bob in the horizontal cross-piece. Measure this distance very accurately. Thereafter, in setting a screen in position it will not be necessary to determine the location of the cross line on the screen by the tedious process of observation with telescope sight or transit, but the screen can be hung in position and a "T" square placed on the horizontal cross-piece, touching the nail, and a perpendicular measured to the required spot on the screen where the cross lines should

be drawn as shown in Fig. 155. This sketch also shows a convenient arrangement for hanging the screens in position.

Test 4. After the rifleman has sighted his rifle in at various ranges for a certain load he may desire to obtain the angles of elevation for that load. In order to obtain a correct table of angles of elevation we must have a zero elevation to work from. The point of impact of a certain load, or its required sight elevation at any range, tells us nothing as regards its trajectory or power unless we know its zero elevation, as a load of very high velocity and low trajectory may actually strike *lower* on the target at ranges of 200 yards and less, than does a load of lower velocity, due to difference in jump or barrel flip. This zero elevation for any load is easily obtained. Suppose the sights on the rifle are $1\frac{1}{2}$ inches above the axis of the bore. The bullet of course begins to fall the instant that it leaves the muzzle. Let us say, for example, that a .30-caliber, 220-grain bullet, at 2000 foot-seconds velocity falls one-eighth of an inch in passing over a $12\frac{1}{2}$ yard range. We can then sight the rifle in on a $12\frac{1}{2}$ yard range so that the bullet will strike with its center $1\frac{1}{8}$ inches *below* the point aimed at ($1\frac{1}{2}$ inches height of sight, plus $\frac{1}{8}$ -inch drop of bullet). This reading of the sight will then give us our zero elevation for that load.

It is possible to translate the graduations on any sight into minutes of angle as described in Chapter VIII, but it is very much more convenient to work with a rifle which is equipped with a rear sight reading to minutes of angle. Suppose we have such a rifle, and on aligning its sights at various ranges, and determining its zero elevation, we arrive at the following with a load giving a velocity of 2000 feet per second:

Zero elevation	sight adjusted at	4 minutes
100 yard elevation	sight adjusted at	7 minutes
200 yard elevation	sight adjusted at	12 minutes

and similarly with the same rifle and a load giving 2600 feet per second we get the following elevations:

Zero elevation	sight adjusted at	10.5 minutes
100 yard elevation	sight adjusted at	12.5 minutes
200 yard elevation	sight adjusted at	15. minutes

If we had the 100-yard elevations alone, or the 200-yard elevations alone for these two loads we might get very much confused because the load of lower velocity actually, in this case, strikes higher on the

target at both these distances, and the novice might conclude that it had a flatter trajectory, and was more powerful. When we determine the zero elevation, however, and tabulate the various angles of elevation we at once see that the apparent difference is due to the fact that the two loads start from the muzzle at different points during the movement of the barrel as it vibrates. As a general rule a load of low velocity strikes lower on the target than one of higher velocity, but this exception to the general rule has been taken here to illustrate the point.

CHAPTER XXXIX

RANGE PRACTICE FOR THE SPORTSMAN

HITTING game with the rifle requires both quick and accurate work. Quick work because the animal may be on the move, or if it be standing still there is no telling how long it may stand. Accurate work because one's target may be merely the head of an animal appearing over a raise in the ground or through timber, and the vital parts of a big game animal even at 200 yards is a mighty small object to hit. Accuracy in game shooting is every bit as essential as accuracy in target shooting. I have no patience with those manufacturers and sportsmen who state that any rifle is accurate enough for big game shooting. I believe that the highest degree of accuracy is essential here. In target shooting the smallest object that has to be struck is usually an 8-inch bull's-eye at 300 yards, a 20-inch bull's-eye at 600 yards, or a 36-inch bull's-eye at 1000 yards. The target that the sportsman is called upon to hit is often much smaller than this in proportion to the range. If the target shot miss the bull's-eye his score is merely lowered a point or two. If the sportsman miss his quarry he may be missing the only shot he will get on a trip that has cost him several thousand dollars and a holiday saved up for several years. Moreover, the sportsman must hit his game quickly with the first shot. There are no sighting shots in the game field.

This gives us an inkling as to what range practice for the sportsman and hunter should consist of. The rifle must first be learned absolutely. Its elevation and zero at various ranges, and in various positions must be determined to a hair's-breadth. Then practice must be started with a view to developing quick and accurate shooting.

Our first problem is then to sight the rifle in. Different kinds of rifles intended for different kinds of hunting should be sighted at different ranges. You would not sight a rifle intended for squirrel shooting at the same ranges that you would one intended for big game shooting in an open country. The distances at which various rifles should be sighted in, and their elevations and zeros found is shown in the following table:

DISTANCES TO WHICH RIFLES SHOULD BE SIGHTED IN YARDS

Type of rifle	Grouse elevation	Woods elevation	Open ground elevation	Other ranges
Small game, 1500 feet per second..	15	40	60	80. 100.
Small game, 2000 feet per second..	15	75	125	150. 175.
Big game, 1500 feet per second....	15	50	100	150. 200.
Big game, 2000 feet per second....	15	100	150	200. 300.
Big game, 2700 feet per second....	15	100	200	300. 400. 500.

Elevations and zeros should be found at the above ranges in each of the following positions: (a) Offhand. (b) Prone with gun-sling. (c) With forearm rest.

Grouse elevation. Every rifle intended for hunting should be sighted in at 15 yards so that it will cut off the head of a grouse when the front sight is held just touching the bottom of the head. The rifle can then be used for very accurate work at very short range.

Woods elevation. This is the elevation that one should ordinarily use in hunting in thick woods, jungle, etc. It is the correct elevation for practically all Eastern shooting grounds. It allows very accurate work at the ranges at which one will usually fire in this kind of country.

Open ground elevation. Intended for ranges rather longer than the ordinary when there is no time accurately to estimate the range. It is the elevation at which one should set his sights when shooting in open country such as that usually found in our West. With a big-game rifle, sights set at this elevation, and aim taken at the vital portion of a large game animal, range unestimated, the vital part will almost certainly be hit at a distance a little greater than the range given, or at any intermediate range.

Other ranges. Rifles should also be sighted for these ranges, which include the greatest distance at which each class of rifles can profitably be used on the kind of game indicated. This kind of shooting may be termed long-range shooting, and a fairly accurate estimate of the range is necessary.

In starting out to target one's rifle it is best first to do so at the various ranges in the "forearm rest" position. A table and chair are provided at the firing point, and a sand bag about 8 inches thick is placed on the table about a foot ahead of the nearest edge of the table. Elbows are rested on the table, back of the left hand is rested on the sand bag, forearm of the rifle is grasped by the left hand in the usual position (see Fig. 155). Determine the sight elevations and zeros at the various ranges as given in the table. This will give one the exact sighting to use when one fires in the field with rifle

rested over a rock or log. For the grouse elevation use a bull's-eye 1 inch in diameter for the target, and aim with the top of the front sight just touching the lower edge of the bull's-eye. For other ranges use a 3-inch bull's-eye for ranges less than 100 yards, a 5-inch bull at 100 yards, a 10-inch bull at 200 yards, and so on. Hold with a normal sight just below the bottom of the bull's-eye, and sight the rifle so that the shots shall strike, not the middle of the bull, but the



Fig. 155

Sighting in a hunting rifle with forearm rest

lower edge of the bull. That is to say, one wants his hunting rifle to strike close to the point where the tip of the front sight is held, not the width of the bull's-eye above the front sight, as is the case with a rifle intended solely for shooting at a bull's-eye target.

Next, do the same thing with the rifle held in the standard military prone position, using the gun-sling exactly as described in Chapter XXV. This is the best position for a very long shot, or a shot which one wishes to make especially sure of, when he has time to assume this position. A little more elevation will usually be required for this position than for the others.

Lastly, sight the rifle in at all the various ranges in the "offhand position." The ordinary rifleman will not be able to hold the rifle

steady enough to obtain accurate results for this purpose in the regular offhand position. With most men it would be necessary to fire several hundred shots at each range and then average the results. This takes too much time. Instead one should assume a position which gives exactly the same results. Such a position can be had as follows: Procure a stout table and chair. Place them at the firing point. Sit down in the chair behind the table, leaning forward with



Fig. 156
Sighting in a hunting rifle with offhand rest

the breast resting against the near edge of the table. Aim at the target with the rifle in the ordinary way, both elbows resting on the table top. Note the location and position of the forearm. Now pile small sand bags around and in front of the forearms in such a way as to firmly support each forearm up as far as the wrist, and at the same time not interfere with the assumption of the regular firing position, elbows rested on the table. This will give a very steady position indeed, and yet the rifle will be held in exactly the same way, with exactly the same tension that it would if fired offhand, and the results on the target will be exactly the same. (See Fig. 156.)

In all this shooting endeavor to have the sun behind you, or else directly above. If this is not possible, arrange a sun shade for the firing point so that your eyes and the entire rifle will be in the shade. This is to avoid the sun striking one side of the front sight which would give one a false zero. Days should be chosen when there is

little wind blowing, and when the temperature is about that which one would expect in the hunting country.

As for the range, it may be anything from a simple extemporization to a fully equipped military rifle range. The author has often sighted rifles in and practiced on nothing more elaborate than a few boards nailed up at the base of a hill, and the target tacked on the boards. The location of each shot was seen when fired by means of a high-power telescope set up at the firing point, and after every ten shots a trip was made down to the target and the paper target changed for a fresh one. One can make very good targets on plain wrapping paper with a pair of compasses, a little lamp black, and a paint brush. If one is doing much of this work, however, it is best to buy printed targets, or have a printer make a wood cut and print the targets for you. Then the targets can be preserved as a part of the record.

After one has sighted in his rifle and learned it thoroughly as described, the next step is practice with a view to developing ability as a game shot. At least four out of five of the shots fired in the game fields will be fired in the offhand, standing position. It is important that we should develop accuracy in this position first. This means lots of slow fire, standing. One hundred yards is a good distance for this practice. It takes lots of practice to make a good offhand shot, practice with special attention to steadiness of position and trigger pull. When one practices offhand shooting on a target there is a constant tendency to try to adopt some position in which one can hold steadier. There is no doubt that one can hold steadier in the hip rest position, rifle balanced on the thumb and fingers of the left hand Schuetzen style, than he can in the regular offhand position with the left arm extended and left hand grasping the forearm. But Schuetzen positions are of absolutely no use in the hunting field. They are not steady when one has been exerting himself recently, when any considerable wind is blowing, or when one has to shoot in a hurry; and it is impossible to use these positions for rapid fire. The sportsman and hunter should stick to the regular offhand position as shown in Fig. 117, and learn to shoot well in that position.

As one endeavors to hold on the target in the standing offhand position his rifle trembles to a certain extent so that the sights, instead of steadying down under the bull as they do in the prone position when the gun-sling is used, travel and "bob" all over the face of the target. Gradually, as one becomes more skilled in holding steady and hard this traveling, and bobbing of the sights becomes less and slower,

and is confined to the vicinity of the bull's-eye and just below the bull's-eye. The first second or two of each attempt to hold the rifle will not be very steady, then will come a period of five or ten seconds when the rifle is at its steadiest, and, after that, if the aim be continued one will begin to tremble again from the prolonged effort. At the start of the steady period of holding, the rifleman should begin the steady pressure on the trigger so as to get it down to that point where an extra ounce of pressure will discharge the rifle. Then, when the rifle seems steadiest, and as the sights drift under the bull, try to press the last ounce on the trigger.

The rifleman who desires to make a success of shooting must think, and think hard, each time that he fires a shot. He must concentrate every particle of his thought and will power on aiming, holding, trigger press, and calling the shot. He must be able to tell exactly what he did each time he pressed the trigger. A skilled offhand shot can call his hit within four or five inches at 200 yards before it is marked at the butts, because he has concentrated and he knows exactly where his sights were aligned at the instant before the recoil caused the rifle to raise in the air and blot out the view of sights and target.

There should be no disturbance to the rifle at all during the instant of fire. The rifleman must endeavor to hold hard all through the recoil. Do not let go or relax at the last instant as the trigger is pressed. Try to continue to hold hard and steady all through the recoil, although of course you cannot do it. The natural thing is for the brain to keep the hands, muscles, and shoulder informed as to what the trigger finger is doing, and the instant that the finger presses on the last ounce to telegraph to the hands, shoulder, and muscles, "Look out! She's going to kick." As a result a flinch occurs. Therefore try your best to avoid this natural tendency, and to divorce all connection through the brain between the trigger finger and the hands, shoulder, and muscles. Concentrate hard on aim, hold, trigger press, and call, so that there is no room for anything else in the brain. Keep the hands, arms, and shoulder lax; that is, don't let the muscles tense up and prepare to meet the recoil. The system and shoulder soon becomes accustomed to recoil. Recoil does not bother a trained rifleman a particle.

After one has become fairly proficient in this offhand, slow fire shooting, he should gradually put a little speed into it. From the time that the eyes first see the target, try to get the shot off as quickly as possible. Imagine that you are shooting at a deer standing where

the target is, and that you are expecting the deer to run at any instant. You want to get a shot in as soon as possible, but that shot *must* strike a vital part. Mr. Stewart Edward White, one of the best game shots in the world, has invented a system of target practice for the sportsman which is intended to develop quick shooting of this order, and this system is given herewith. This system, or one similar to it, should be taken up as soon as the rifleman is fairly proficient in slow-fire, offhand work. Do not try to work too fast at first. Never go so fast that you do not get a good aim, and a good trigger press. Get the speed gradually. You will notice that the system is arranged



Fig. 157

Springfield sporting rifle used by Stewart Edward White on first expedition in British East Africa

so as to require you to do this if you are to get good scores at it. By keeping at this system, say one afternoon's practice a week, a fair offhand shot is sure to develop into a very quick and sure game shot. It develops the rifleman who makes a clean kill with the first shot.

STEWART EDWARD WHITE SYSTEM OF RAPID FIRE RIFLE PRACTICE

The object is to develop quick accurate fire, a quick shot, but a sure kill with that shot; the kind of shooting which will give the best results in the game fields. We set up an ordinary military, 200-yard target A at 100 yards. The marksman faces the target, stock of the rifle below the elbow. At the command FIRE he gets into action and shoots as soon as his judgment dictates. The referee has taken the exact time between the command FIRE and the report of the rifle, $2\frac{1}{2}$ seconds he announces, and jots the figures down. The marksman reloads, stands again with the stock below the elbow, and the process is repeated. At the end of a five-shot string his time runs as follows: $2\frac{1}{2}$ sec., 2 sec., 2 sec., $1\frac{1}{2}$ sec., 3 sec.—total 11 seconds. Now, and not until now, the marker marks the location and value of the five shots. The marksman has made a bull, three fours, and a three. The scorer refers to this table:

Time, seconds for 5 single shots	Bull's-eye counts	4-ring counts	3-ring counts	2-ring counts
20	5	4 ¹	3 ¹	0
19	6	4 ¹	3 ¹	0
18	7	4 ¹	3 ¹	0
17	8	5	4	0
16	9	6	5	0
15	10	6	5	0
14	11	7	6	0
13	12	8	7	0
12	13	8	7	0
11	14	9	8	0
10	15	10	8	0

¹ The idea in counting these alike is that any man ought to keep in the four or three ring in 18 seconds or more, although an 18-second bull is more creditable than a 20-second bull.

Under 11 seconds the bull's-eye counts 14, the four ring 9, and the three ring 8. Therefore the marksman has made a total of 14-9-9-9-8 equals 49 points.



Fig. 158

Top view of Stewart Edward White's Springfield sporting rifle used on his first expedition in British East Africa

It would not be fair to count each shot according to its own time rather than according to the aggregate time for firing the string. If this were done a man might prefer to shoot very wildly and rapidly into the "three" ring for three or four shots, and then plant a deliberate bull or so to pull up on, or the other way around, as his judgment advised. The scheme proposed insists on consistency. It will also be noted that this table is only for an aggregate of single shots, each started with the stock below the elbow, and not for magazine fire. The same game can be practiced, with the same table, at a deer or other game-shaped target. The target may be natural color against an ordinary background of earth and grass. Shoulder shots count 5, middle shots 4, and the remainder of the animal 2.

RAPID FIRE

It still remains for the sportsman to develop his ability at magazine fire. This is half learned already if the rifleman has been practic-

ing the White system. It is only necessary to learn to operate the mechanism of the rifle quickly and surely, and to get used to the quick recovery from recoil. Always keep the butt of the rifle at the shoulder during rapid magazine fire. Immediately after one has fired a shot, let go with the right hand to operate the rifle, and pull back hard with the left hand so as to pull the butt of the rifle against the shoulder and hold it there as one operates the breech mechanism. Hold the rifle hard in this position with the left hand and quickly and positively operate the rifle with the right hand. Then grasp with the right hand, relax with the left, catch the aim, and start the trigger

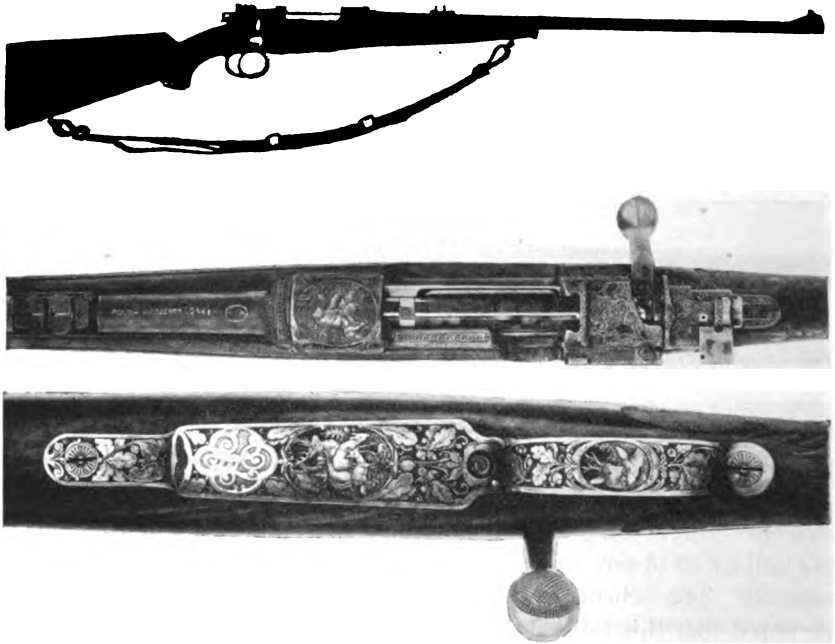

Fig. 159

Mauser rifle for the .30-caliber Model 1906 cartridge, the property of Mr. Edward C. Crossman. Rifle has a Poldi anti-corro steel barrel. Cuts show the top of the action and the magazine floor plate

press. The first time that the sights swing on to the mark you must be all ready to press the last ounce on the trigger.

In the sitting position keep both elbows on the knees, or at any rate the left elbow. In the kneeling position keep the left elbow on the left knee. In the prone position, if using a bolt-action rifle, keep both elbows on the ground; as you pull back the bolt press the barrel

of the rifle over to the right and low, thus making it easier to operate the bolt. As you close the bolt bring the barrel up and to the left until it is again in line with the target. A little practice at this makes one so adept at it that the sights will come back almost exactly aligned on the bull's-eye after each operation of the bolt.

Mr. Edward C. Crossman has arranged a system of magazine target practice based on Mr. White's idea which is excellent for both individual practice and for competition. This system is given herewith, and the rifleman practicing with an idea to increase his ability with the hunting rifle cannot do better than practice it.

THE CROSSMAN SYSTEM OF MAGAZINE RAPID FIRE PRACTICE

Taking up magazine fire is merely carrying out Mr. White's idea — if one shot, accurately and quickly placed, is good, then five times this number, if they are as well placed and as carefully pressed, would be five times as good under certain circumstances. We alter the table worked out by Mr. White and make it read like this :

Time for five shot strings	Bull's-eye counts	4-ring counts	3-ring counts	
20 seconds	5	4	3	For every shot which strikes in the 2-ring, or every miss, deduct 3 points from the total score.
19 seconds	5	4	3	
18 seconds	6	5	3	
17 seconds	6	5	3	
16 seconds	7	6	3	
15 seconds	7	6	3	
14 seconds	8	7	4	
13 seconds	9	8	4	
12 seconds	10	9	4	
11 seconds	11	10	5	
10 seconds	12	11	6	
9 seconds	13	12	7	
8 seconds	14	13	8	
7 seconds	15	15	9	

The marksman starts with his rifle held at ready, stock below the elbow, piece locked or at half cock. At the command FIRE he fires five shots at the target as rapidly as he pleases. The referee takes the time from the command FIRE to the report of the fifth shot. The score is then calculated from the above table.

Note. In the White and Crossman systems it is intended that the military target A with 8-inch bull's-eye should be used for 200 yards, and for shorter ranges the same target reduced proportionately.

CHAPTER XL

SHOOTING AT MOVING OBJECTS

IN shooting at moving objects, such as game in motion, it is of course obvious that aim must be taken in front of the object in order to hit it so as to allow for the movement of the object during the time that it takes the bullet to fly from the rifle to the object. We will suppose that a deer is running at right angles across the line of fire at a range of 200 yards, and that the speed of travel of the deer is five yards per second. It takes a bullet fired from the .30-caliber, 1906 cartridge at a muzzle velocity of 2700 feet per second .243 second to travel 200 yards. During this time the deer will run approximately 4 feet. Theory therefore says that the sights should be aligned approximately 4 feet ahead of the vital part on the deer's shoulder that it is desired to strike at the instant that the bullet leaves the muzzle of the rifle. If the animal is moving across the line of fire at an angle of 45 degrees instead of 90 degrees, the allowance must be just half of this, and proportionately for other angles. The following table gives the time of flight in seconds for the .30-40 cartridge, 200-grain bullet, 2000 feet per second, and the .30-caliber, Model 1906 cartridge, 150-grain bullet, at 2700 feet per second.

TIME OF FLIGHT

Distance, yards	.30-40 cartridge, seconds	.30 Model 1906, seconds
100	.159	.116
200	.337	.243
300	.537	.384
400	.761	.693
500	1.012	.709

This is all right as far as theory is concerned, but in addition one must consider the time it takes for the brain to signal to the trigger finger to pull, the time it takes actually to pull the trigger, the lock time of the rifle, and the primer, powder, and barrel time. In addition, while we may shoot on a range at a mechanically run deer target and know exactly how many feet per second it travels, who can tell the exact speed of a running wild animal in its native woods? And

when a buck jumps and starts to run who has time to calculate lead from the time of flight of the bullet?

I have been up against the game many, many times on the real animal in his native wilds, and the best advice that I can give the novice is to hold ahead and swing with the animal, trying to get the trigger pulled when the sights appear aligned at the following distances in front of the point of the chest: For an animal running at a pretty good clip, and crossing the line of fire at an angle of about 90 degrees, and at about 100 yards range, get the rifle off when the sights are aligned about 18 inches ahead with rifles of about 2000 feet per second velocity, and about 6 inches ahead if using a rifle of about 2700 feet per second velocity. For animals running at medium speed, or crossing the line of fire at an angle of about 45 degrees, lead about 6 inches with rifles of 2000 feet per second velocity, and have the sights just touching the point of the chest with rifles of 2700 feet per second velocity. If the target is a bounding deer, try to pull just as the deer is at the height of his bound, and in addition to leading him the specified amount, hold about a foot low. For 200 yards double the lead. With a low velocity, black-powder rifle, double or triple the lead for the 2000 feet per second rifle. It is hardly worth while firing at ranges over 200 yards unless you can see dust where the bullet strikes, and thus get a line on the correct hold for the second or third shot. In firing at running game, if you don't make a hit with your first shot, operate the rifle as quickly as possible, and try another, and another shot with the same lead as at first. High-velocity rifles are very much better for shooting at moving game than those of low velocity. I should say that a man using a rifle having a velocity around 2700 feet per second stands 100 per cent. more chance of hitting than if he were using a rifle of the 2000 feet per second class. This is all that can be told on paper. The rest of it requires practice, and lots of it too.

One can acquire much valuable practice at this kind of firing by shooting at a running deer target. The swing with the animal, and the selecting of a certain lead, and then the pulling when this estimated lead is attained all require much practice to perfect, and this practice can be had very nicely on a mechanically run deer on the range. Only the sportsman must remember that when he gets to the hunting country he will never know the speed at which the animal is running, nor the exact range.

A thoroughly practical running deer target can be rigged up in

the following manner. Dig a trench 30 yards long and $1\frac{1}{2}$ feet deep, across the rifle range near the butts. At each end of the trench plant stout posts, about 6 inches x 6 inches, seating them at least 2 feet in the solid earth. Stretch a 30-yard piece of 8-gauge galvanized or coppered iron wire between these two posts, attaching it to the posts by strong turnbuckles. This wire should run in the center of

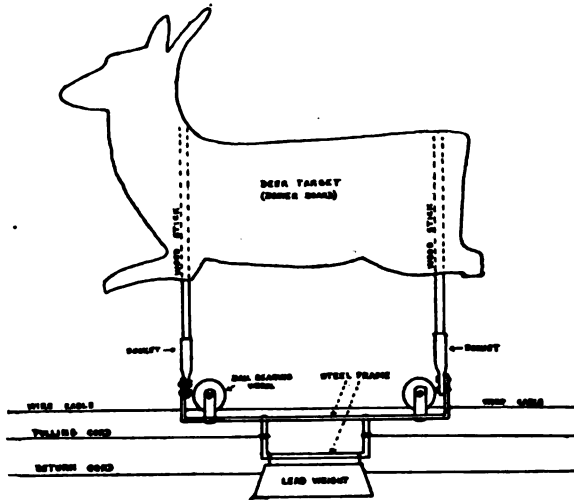

Fig. 160

Carriage for running deer target, showing construction

the ditch, and several inches below the surface of the ground. Next, go to a mechanic and have him build a steel carrier similar to that shown in Fig. 160. The wheels should be about 2 to 3 inches in diameter, with ball bearings, and placed about 15 inches apart. The two sockets in which the sticks which carry the target fit should be about 22 inches apart. Under the carriage is a weight which keeps the target upright. This carriage runs along the taut wire as shown, carrying the silhouette of the deer. The carriage runs in the ditch below the surface of the ground where the bullets will not strike it, but the silhouette of the deer appears above the ground as though it were running along the surface. The deer should be made of some very stiff composition building board such as "Beaver Board," and should be sketched to life size and in running position by an artist, and then cut out. Keep one as a model and you can cut out any number required. Paint the target mouse or khaki color so that it

can be just slightly discernible against the background of the range.

For motive power an endless braided cord is run through a ball-bearing pulley attached to the post at one end of the trench. At the other end it is given two turns around a bicycle wheel. This bicycle wheel, minus tire, but including the rear portion of the bicycle frame with sprocket wheels, chain, and one pedal, is attached firmly to a framework and stakes or posts so that it will not move. The bicycle and sprocket wheels should be geared as low as possible, otherwise the deer will run too fast. The endless cord, besides going through the pulley, and twice around the wheel, is attached to the carriage carrying the target. When the operator takes a hold of the pedal and revolves the wheel the deer and carriage run from one end to the other of the 30-yard trench. At the end of the trench where the bicycle wheel is set up a butt must be built. This consists of a parapet about 10 feet long, 7 feet high, and 4 feet thick at the top, revetted with a board wall on the side away from the firing point. The operator sits behind this when working the wheel. At the other end of the trench is a screen of some sort — canvas, boards, or brush — behind which the deer disappears or starts.

The deer can be started from either end of the trench. It is hidden by either the screen or the butt before it starts to run. Upon a signal from the firing point the operator works the wheel so as to cause the deer to run across the open space at a prearranged speed. The rifleman may fire at any time while the deer is visible. After the run is made the deer is pulled back to the butt, if not already there. The operator then runs up a red danger flag above the butt, notes the hits, if any, on the deer, runs the deer a little way out into the open, steps out and indicates the hits on the deer by means of a disk on a stick, pulls the deer back behind the butt, pastes up the shot holes, and lowers his red danger flag, thus indicating that he is ready for another run. In time the deer target will get badly shot up, and another target will be needed, but the remainder of the material, carriage, wheel, etc., if cared for, will last for several seasons. A miniature arrangement of this kind can also be operated in a gallery.

CHAPTER XLI

THE RIFLE IN THE WILDERNESS

THE shotgun takes its bearer out into the ploughed fields, and the patches of woods near civilization. But the rifle entices its owner into the wilderness, and the waste spaces of the world far beyond the marks of the axe, and the sound of the railroad. To the man in whom the primitive virtues and red blood have not entirely been sapped by modern civilization there is scarce a joy comparable with that of wandering in the wilderness, winning one's way unaided, depending upon rifle and axe for food and shelter, feeling his manhood tested and found fit. There is a lot of difference between an arm most perfect for range work, and one which must stand the gruelling test of constant use in the real wilderness. Imagine rain and snow for days with only a flimsy canvas shelter at night, dust storms in the desert, the sweat and humidity of the jungle, the temperatures of the arctic circle. Again the times that one simply must use the butt as an aid in rough mountain work, or when the horse slips in a ford, or the dog sled turns over with the rifle strapped on top, or the canoe gets upset in a rapid with the rifle tied to a thwart by its sling. We must have strength everywhere, and ability to clean easily, in a rifle intended for such work.

When you are just dog tired at the end of the day's trail, when there is camp to make, and supper to get, and many another thing to do, there is still that dirty wet rifle to clean. It will be overlooked or slighted unless you have by foresight reduced the operation to its lowest denominations.

For real wilderness work, for big game hunting and exploring, I like the bolt-action rifle. Its action can be entirely dismantled in an instant without any tools. One wipe over with a dry rag cleans and dries it, and another once over with an oily rag lubricates it and prevents rust. The dismantling of the action puts the barrel in the best position to be cleaned quickly from the breech. Such a rifle should have a strong, heavy stock, thick at the grip, its weakest part. It should have the sights well protected, and the working parts should be sharply checked to prevent the slipping of the fingers when numb with cold or

enclosed in heavy gloves. On a canoe trip such an arm needs a waterproof case to protect it. Not such a case as one finds in a sporting goods store, but one of waterproof canvas or waterproof silk, unlined, which will not absorb dampness, nor be useless after an upset. The



Fig. 161

An American rifleman in northeastern Canada

rifle is normally carried in its case, case strapped to a thwart of the canoe. In the far Northwest the Indians invariably carry their rifles in cases up to the very minute when they sight game; this keeps off the snow and the wet, the perspiring hands which cause rust. On a horseback trip a heavy leather holster is a necessity. The holster is tied to the saddle by the thongs at pommel and cantel, and hangs on the left side of the saddle, the barrel passing between the two stirrup straps, and the butt coming on the left side of the horse's shoulders, but not up

as high as the withers. It is best protected in this position, and can be quickly snatched out when one dismounts.

The cleaning kit must be small, well packed, and so arranged that it will be handy for use. My own kit gives an idea of about what is needed.

On the rifle, in recess under butt plate and reached by trap in butt plate:

- Thong and brush (field cleaner).
- Pocket oiler.
- Flannel cleaning patches.
- Broken shell extractor.

In pockets:

- Spitzer greaser filled with Mobilubricant.
- Oily chamois skin for wiping off.

On the belt only those things needed in a great hurry:

- 5 rounds of full charged ammunition.
- 5 rounds of reduced load ammunition.

In pack or rucksack, always on person:

- 15 rounds of full charged ammunition.
- 15 rounds of reduced load ammunition.

In camp duffle, done up handily in a small canvas roll:

- Jointed cleaning rod.
- Can of rifle oil.
- Bottle of ammonia swabbing solution in traveller's bottle.
- Waterproof bag of flannel patches.
- Small can of Mobilubricant (extra supply).
- Small handy screwdriver.
- Spare firing pin.
- Several wiping rags.

At the close of a hard day's work, when the cleaning of the rifle is in order, spread a piece of canvas on the ground near the fire. Take your rifle and the canvas roll of cleaning materials and sit down. Take out the bolt, and open up the canvas roll. Then go to it. In five minutes you will be through without having to get up, and without your pipe going out.

In the wilderness everything will be different from what one has been accustomed to on the rifle range. The target will be on the move, or liable to be any instant. This calls for quick work. But also the

target may be practically invisible, in fact it usually is. The untrained eye seldom sees game in the wilderness because of its protective coloring, and when it is once seen it is like looking at a bull's-eye to see



Fig. 162

An American rifleman in Central America

what part of it is a little blacker than the rest. And yet in that target you must pick out a certain vital spot, and fire at it with steady hand, clear sight, and careful trigger press or you will miss the whole blooming thing. And you may just have been climbing a five thousand foot mountain as steep as a mansard roof, or running at top speed, and your heart is working like a race-horse, and your muscles all a'tremble. Game shooting is a man's game, and one that takes experience, and yet it is a game that is quickly learned by a good target shot once he has learned the knack of seeing the game.

The man who spends his whole time in the wilderness, the trapper, and hunter, and guide, is seldom a good shot except at short ranges. It takes a lot of target range experience to impress upon one the extreme nicety as regards sight adjustment, aim, and trigger press that are necessary to insure success at long range. But the average sportsman is far worse because he invariably believes that he is a born shot and does not need practice. I have seldom found a sportsman who, in preparation for a big game hunt, has gone out to a rifle range more than once in a season, and the majority of them have not even done that. By far the best game shot is the man who has done a lot of scientific and careful range practice, combined with military rapid fire, and who has hunted enough to have gotten on to the knack of seeing game in its native wilds.

If you were going to shoot a rifle match on a certain date, you would, if you could, practice every day. That rifle match may net you a small medal, perhaps a little reputation. But on your fall hunt you leave home with the full knowledge of your friends for the express purpose, let us say, of going on a sheep hunt. The big-horn is the finest trophy that can fall to the rifle of a sportsman these days. Game is getting very scarce, and on a long hunt you may get but one or two shots. This hunt may cost you a thousand dollars. Which is the most important match to train for, the target match of ten shots or so on a black and white target, or the matching of your skill against that big-horn on the mountainside? Why not practice assiduously all the time that you are on your hunt? Firing will scare away the game, but you have unlimited chance for position and aiming drill under every condition of light and target that you will encounter on your trip. Therefore you would do well to get in lots of this snapping practice morning and evening. After a time the handling of your rifle will seem like second nature. It will seem to be a part of you, a part that you can even work effectively in the dark at short range without any aim.

There is need of becoming thoroughly familiar with one's weapon, far greater need than any one without wilderness experience would suppose. If one is to be successful in the wilderness with his weapon he must know it so well that he has absolute confidence in it. The mistakes which the tenderfoot makes are at once humorous and pitiful. Here are some that have come to my own attention and that I can vouch for.

One sportsman and his guide stalked to within fifty yards of a

bull elk. The guide showed the sportsman the elk standing broadside. For almost a minute the sportsman stood looking at the elk, and the guide finally told him to shoot quick before the animal ran, so the sportsman pointed the muzzle of his .405 Winchester into the air, and

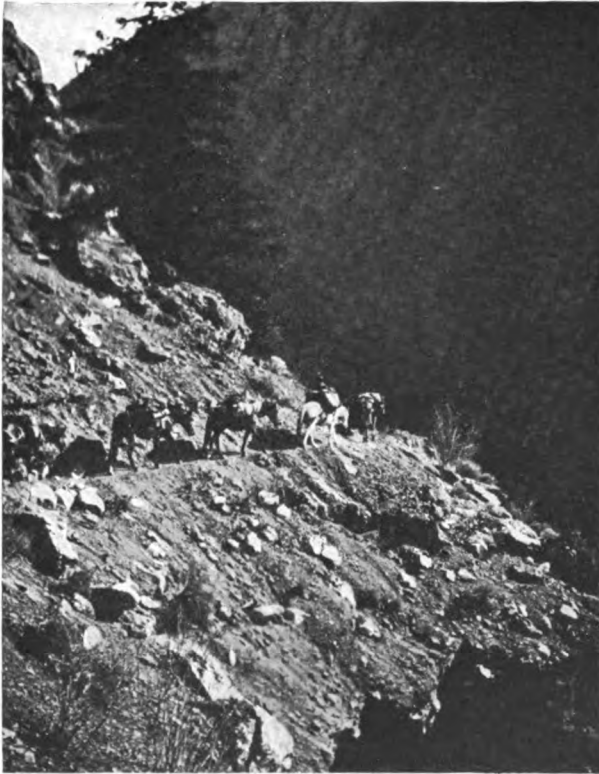

Fig. 163

The author's pack train in British Columbia

working the lever like lightning, threw every cartridge out of the gun without firing a shot.

Another sportsman with a guide of my acquaintance was hunting moose with a sporting Springfield. When the moose was jumped the sportsman first unlocked his rifle, then locked it, then (it seemed as though he did it deliberately) got the bolt handle hooked under his waist belt, and when he finally did get ready to fire the moose had vanished after having stood perfectly still in full view for over 30 seconds.

These are cases of buck ague, that is, of extreme excitement, but they are both failures in functioning the rifle, and they come from inexperience and lack of confidence in operating the arm. The skilled shot may get buck ague the first time or two that he sees game, but it will affect him differently; he will simply be so excited that he cannot hold the rifle steadily when he aims.

It sometimes happens that one has plenty of time for a shot. The game may be feeding and entirely unaware of one's presence. But in the majority of standing shots one does not know at what instant the game is going to start off, and once started it takes a remarkably short time for it to get out of sight, even on open ground. Therefore the majority of shots one will get will be snap shots. I do not mean by this that one should hurry, but in practice for hunting one should get used to pressing the trigger the instant that the sights touch the object the first time, and not waiting until they have swung past and around the object several times and steadied down as in slow-fire, target shooting. To give the novice an idea I should say that four seconds would be about the average of time between the instant that one makes up his mind to fire and raises the rifle, and the report of the shot. In running shooting it may be a little less than this. Get the rifle up to your shoulder and approximately aligned as quickly as you can. Practice throwing it to your shoulder and try to have it come up so that it is almost perfectly aligned when you first look through your sights. Make these movements as quick as lightning, and then slow up, and spend as much time as you dare on steadying down, holding hard, gradually increasing the pressure on the trigger, and easily pressing on that last ounce just as the sights first drift on to the vital spot you want to hit. If the game is walking or running through thick timber, don't try to swing with it. You cannot see it well enough and the trees will confuse you. Instead, pick out an open place through which it must pass, aim at that, and the instant that your sights touch the game, fire. Never shoot at the whole animal. That is a very good way to miss it entirely. You must pick out some vital spot and aim to hit that. Game does not always stand broadside on as the artist delights to paint it. In fact in most cases you will find that it has its south end to you and is bound north at a very good pace. Aim just behind the shoulder for a broadside shot, just at the point of the chest for a head on shot, and just under the tail for a rear shot. Always aim a trifle below the center of the body, particularly in down-hill shots. The tendency in down-hill shots is to overshoot because you see the top of

the animal, not because your bullet goes high. On either up or downhill shots the only distance you want to allow for is the horizontal distance, not the distance on the slope. On most game a shot behind the shoulder often means that the animal will not drop right away,



Fig. 164

An American rifleman in the jungle

even if shot right through the heart, but may make a wild rush for several hundred yards and then fall dead. If you have made what you think is a good shot on game and it has run right off follow it for a couple of hundred yards to see if it is a case of this kind. If you don't come across the animal in that distance sit down and wait an hour before following further. This gives the animal a chance to stiffen up. If you followed it at once and it was badly wounded it would probably jump up and make off as soon as it heard you, and lead you many miles, whereas if let alone it will probably only go half a mile or so

and then lie down. In a little while it is too stiff and weak to move again.

Always fire as though your first shot was the only one you were going to get. Often it is. Try for a clean kill on the first shot. You can take much pride in such a shot, and there is good sportsmanship in it. It does away with needless suffering. Pattern yourself after the Boer who said to his son: "Here is a cartridge, go fetch me an antelope." But always remember this; after the first shot with which you have tried your level best, work the action fast, and if possible get in another shot right away, and then a third. Shoot as long as the game is in sight or moving, but always get a good aim for each shot. Don't pull them into the landscape. Practice in rapid fire on the military range is excellent practice.

I append herewith certain maxims of the still-hunter's craft by Horace Kephart which I think it would be well for all hunters to memorize:

1. Hunt one kind of animal at a time, and think of *it*.
2. Know its strong points and its weak ones.
3. Know where to hunt, and where not to.
4. Choose favorable ground.
5. Consider the animal's daily habits.
6. Know just what to look for.
7. Maneuver according to a definite plan.
8. Work against the wind, or across it.
9. Move noiselessly, and reconnoiter carefully.
10. Try to see the game before it sees you.
11. Keep cool.
12. Never fire at anything until you are absolutely certain that it is not a human being.
13. After firing reload instantly.
14. If you wound an animal, don't follow immediately upon its track unless you are sure it is shot through the heart.
15. Be patient over ill-luck, and keep on trying.

To which I add a couple of words of advice of my own. Turn your back to the wind. Now every animal in a sector of fifteen degrees on either side of the direction in which you face, and for about half a mile in that sector is perfectly aware of your presence unless you are on a very high hill. There is no use in hunting in that sector, the wind has carried your scent to everything. You can crack little sticks and

kick up the leaves a little, and brush against the undergrowth and it will not alarm the game unless you make an ungodly racket. Every animal in moving through the woods makes a little noise of this kind. But just cough, or sneeze, or blow your nose, or rattle your rifle, or strike a rock with a piece of steel, or speak above a whisper, and everything within hearing has departed for safer country, and game can hear a sound just about three times as far as you can.

And lastly let me add what I think is the most important piece of advice of all. **Be ALERT.**

CHAPTER XLII

THE CLEANING AND CARE OF THE RIFLE

THE rifle is a piece of fine mechanism. It must be kept clean, free from rust, and well lubricated if it is to do good work, even passable work, and if it is to remain in serviceable condition. The cleaning and care of the rifle is an important matter which merits the serious consideration of all riflemen. It is worthy of note that practically all inquiries that I have had on this subject have been from riflemen who were not looking for the proper method of cleaning, but rather for a way of restoring a weapon which had become in bad condition through lack of intelligent care. Once a rifle bore is allowed to become rusted and eaten by the acids of fouling there is no way to return it to its former degree of excellence. A rifle may be ruined for accurate work by two days of neglect. On the other hand, a rifle properly cared for should last a rifleman for almost a lifetime of ordinary use if he only care for it properly. The work resolves itself into the cleaning of the bore after firing, the preservation of the bore from rust, the cleaning and lubricating of the working parts, and the care of the exterior of the arm.

The cleaning of the bore. With black powder rifles the cleaning of the bore is a simple matter. A wood, steel, or brass cleaning rod is used. The bore is cleaned by means of small patches of flannel or other cloth on the rod. A patch is placed over the chamber or muzzle, centered with the tip of the cleaning rod, and pushed through the bore. It is then worked up and down in the bore, thoroughly swabbing it. The first patch or two should be wet with water to wash out the black carbon fouling, then should follow a number of dry patches which thoroughly dry and clean the bore, and following these a patch or two saturated with a heavy grease or any oil having a good body which will give an oil coating which keeps away moisture and prevents rust. This is all that is necessary for the ordinary black-powder arm. The smaller the caliber of the rifle, the more thorough this cleaning has to be. With a .22-caliber rifle it is always advisable to clean on the following day. Cleaning should always be done not later than

the evening of the day on which the rifle was fired. A rifle should never be left over night without cleaning.

While this method of cleaning the bore will suffice for the old rifles using black powder only, such cleaning will positively result in the ruination of the bore of a smokeless powder arm. In the black-powder rifle we had only a neutral carbon fouling. In smokeless powder rifles the fouling deposited by the fired cartridge is of entirely different nature. We must understand the character of this smokeless fouling before we can proceed to intelligently remove it and make the bore chemically clean.

Black-powder cartridges require only a weak primer to ignite them, but a much more powerful primer is required to properly ignite smokeless powder. The fouling of smokeless powder of itself is seldom harmful to steel, except that it presents a substance that is liable to retain moisture in contact with the steel of the barrel. When we fire a smokeless cartridge in a rifle we deposit in the bore the fouling of the primer, powder, and possibly some of the metal from the bullet itself. As stated, the fouling of the powder itself would probably do no harm, but the fouling of the primer is extremely acid, and at once gives to the entire fouling a very acid character. Acid in contact with steel means eating and rust. We must neutralize and remove every particle of this acid fouling. An alkali will neutralize acid, therefore for smokeless powder the cleaning solution should always be alkaline in character. It happens also that smokeless fouling is almost always very sticky and tenacious, and it is much more difficult to remove it than black powder fouling. A solution of sal soda in water furnishes an effective alkaline cleaning solution, but unless it is used very hot, almost boiling, it has a little effect in removing the stickiness of the fouling. Experience has shown that a solution of amyl-acetate and acetone in oil works very well as a solvent of sticky smokeless powder and primer fouling. It will dissolve and neutralize both, and can be used cold. The best formula is :

Amyl-acetate	2 ounces
Acetone	2 ounces
Cylinder oil or any gas engine oil having a good body.....	1 ounce

Dissolve the oil in the amyl-acetate, using only as much oil as the acetate will take up, then add the acetone a little at a time with thorough shaking. Or if the rifleman prefers he can use the commercial liquid known as "Hoppe's Powder Solvent No. 9," which is practically the same thing and which is very widely used. The first three or four

cleaning patches should be wet with this solution and the bore scrubbed very thoroughly. Then use dry patches until the bore appears clean and a patch pushed back and forth several times comes out clean. Then oil the bore thoroughly. This cleanser or the hot sal soda solution works very well for smokeless powder rifles of low velocity and using lead bullets, but it should be particularly noted that this method or these solutions are of *almost no use at all* in cleaning high-power smokeless powder rifles using jacketed bullets.

When we introduce the jacketed bullet, and the consequent high pressures, with the smokeless powder charge, we greatly complicate matters. We not only have the powder fouling, and the acid primer fouling, but we also have the bore practically nickel or copper plated throughout. This metal plating of the bore is called metal fouling. It may consist of a very thin, invisible coating of copper or cupro-nickel from the jackets of the bullets, or it may be so bad that plainly visible lumps of this metal can be seen adhering to the bore of the rifle, particularly near the muzzle, after the bore has been partially cleaned. The difficulty in this class of rifles arises from the fact that this metal fouling is distributed throughout the bore, and also has imprisoned under it a large quantity of the acid fouling. Ordinary methods of cleaning have no effect whatever on the metal fouling. The result is that ordinary cleaning only removes the powder and primer fouling *above* this metal fouling. After an ordinary cleaning the bore appears clean to the eye, but if it be placed away for a day or two in this condition it will be noticed that the fouling *under* the metal fouling has begun to get in its bad work, has begun to rust and eat into the steel. No matter how thoroughly the bore was cleaned by ordinary methods at first, after a day or two the bore will again appear very dirty, or if no attention is given to it for four or five days it will be found full of rust. Many riflemen clean with ordinary methods, cleaning every day for five or six days after firing. They are only performing much unnecessary labor, and are really only polishing off the rust that appears from day to day. Every particle of rust means so much metal removed from the bore, means small rust holes or pits, means a gradual ruination of the bore. Such lack of intelligent care, no matter how thorough the scrubbing every day, will result in great deterioration of the bore during a single season of steady shooting.

It is obvious that the solution of our difficulty is to use some material or liquid that will dissolve the metal fouling, and allow our cleaning solution to get at the acid fouling which is always imprisoned under

it. Happily we have found that a very strong solution of ammonia will do this, and also that ammonia is a very strong alkali and will neutralize and wash out acid fouling in a very perfect manner. Therefore, with high power rifles using jacketed bullets the only satisfactory method of cleaning is to use a strong solution of ammonia first, swabbing or soaking the bore thoroughly in this, then dry the bore thoroughly and clean it with dry patches, and then oil it. This method works excellently, and is so efficient that it should be adapted for all smokeless powder rifles, whether using jacketed or lead bullets, thus simplifying matters by using only one method for all kinds of rifles. We will now go into the details of cleaning a modern rifle.

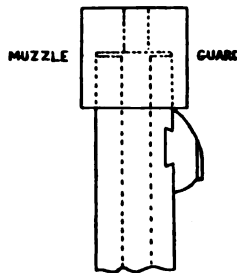

Fig. 165

Correct shape for tip of cleaning rod, and details of construction of muzzle guard

Cleaning materials. For the proper cleaning and care of the rifle we need a cleaning rod, a quantity of flannel patches, a wiping rag, a bottle of ammonia solution, and a can of oil. These articles require separate discussion.

Cleaning rod. The best cleaning rods are of polished steel. Ammonia attacks brass cleaning rods and makes a dirty mess of the operation of cleaning. Wood rods are apt to carry grit and dirt which acts as an abrasive of the steel, and besides are very prone to break and get stuck in the bore. The rod should be as large as the diameter of the bore of the rifle will permit, as the larger in diameter the rod is the stiffer it is and the less liable is it to break or bend so as to rub the bore. Jointed rods are most convenient for field use, and those intended

for hunting rifles should have joints about 9 inches long so that they will pack well in all forms of packs. Such rods should always have long dowel pins in the joints to make them as stiff as possible. For hard range use, day after day, the solid rod is by far the best. If the rod has a handle it should have a swivel ball bearing so that the rod and patch will turn in use and the patch will follow the rifling instead of rubbing square across the grooves and lands. A handle, however, is not necessary, and I prefer a straight steel rod without any handle as such a rod can hardly be held against revolving with the rifling, and with such a rod one takes care not to use too large a patch as he cannot force the patch in without a handle. With a rod without a handle one is less liable to use too large patches which get stuck in the bore. Fig. 165 gives the best shape for the tip of the cleaning rod. A slotted rod should not be used as the patch is liable to run all on one side of the rod, and the uncovered side of the naked rod rubs and wears the bore.

Flannel patches. These should be cut from a medium thickness canton flannel. The piece of flannel should first be put through the laundry, or thoroughly soaked in water and hung up to dry several times, before being cut up into patches, as this greatly increases its power to absorb the cleaning solution and oils, and also the dirt in the bore. New canton flannel is almost waterproof. The size of the patch depends upon the size of the tip of the rod, and the size of the bore. For a .22-caliber patch a piece about half an inch square is about correct. For .25 caliber about three-quarters inch, and for .30 caliber and larger about 1 inch. The exact size should be determined by trial, the patch being about correct when it requires a pressure on the handle of the rod of about 5 pounds to force it through the bore after it has once been seated in the bore past the muzzle or chamber. If one is doing much shooting it pays to determine the size for a round patch, and then procure a shotgun wad cutter, and cut the patches in quantities with this. Keep the patches in a tin can or waterproof bag so as to keep them dry. In the tropics or other very damp climates always dry the patches before the fire or over the stove before use.

Wiping rags. These are for wiping off the exterior of the rifle, breech mechanism, etc. The best are made of bird's-eye linen which absorbs moisture very readily. Have one for wiping off dirt and moisture, and another one well oiled with which to give the rifle and action a final rub. For the hunting fields it is very convenient to carry in the pocket an oily piece of chamois skin with which to wipe the rifle off

from time to time. Such a rag keeps the rifle in fine condition, preserves the finish, and is a great saver of oil.

Ammonia swabbing solution. This solution should be made up as follows :

Stronger ammonia containing 28 per cent gas	6 ounces
Ammonia persulphate	28 grains
Water	4 ounces

Any large druggist can make this up, small shops may not have the correct ingredients on hand. One-fourth the above quantity is enough for an individual rifleman to have made up at one time. It should be placed in a bottle a little larger than the full amount of the liquid, and the bottle must have a rubber cork. For rifle range use one of the bottles with patent rubber stopper such as citrate of magnesia is always sold in at drug stores is very convenient. For hunting the best container is one of the little bottles with red wood cover that Waterman's fountain pen ink is packed in for traveller's use. This bottle has a rubber cork and dropper combined, and is so held in the wood cover by springs that it is not liable to break nor the cork to come out. The bottle must be kept tightly corked at all times except for the instant that it is opened to wet the patch. If the solution is exposed to the air it loses its strength very rapidly. For the same reason it should never be kept over two months, but fresh solution should be mixed.

Oil. The thin oils usually for sale and so extensively advertised are not satisfactory. They run off the metal and leave spots exposed to the damp air. They have not body enough for either rust protection or lubrication. The best oils are those which have about the same body as sperm oil. Sperm oil is very good and very cheap. Neatsfoot oil is also very good, and in addition you can use it for keeping your leather goods waterproof. I have used Marble's Nitro-solvent Oil for many years with excellent results, but in very cold weather it becomes almost like wax. Any of these oils do splendidly in the bore to protect it from dampness for several days, and also are fine for lubricating the action in all but the coldest weather. In very cold weather the action would either be wiped free from all oil, or a non-freeze oil like Rem-Oil should be used. When the rifle is put away for a long time no thin oil is safe as a rust preventative. Instead one should use a very thick coating of any of the gun greases such as Winchester gun grease, Corol, Black Diamond gun grease, mercurial ointment, or any of the petroleum jellies that are free from acid. Oil is best carried in a can. Provide a supply of not less than four ounces

per month for hunting trips, double this amount for the tropics.

Muzzle guard. If a rifle cannot be dismantled or the breech bolt taken out so that the bore can be cleaned from the breech, it is very necessary to watch the muzzle very closely while cleaning it to see that the cleaning rod does not rub the corners of the lands and grooves at



Fig. 166

Cleaning a repeating rifle from the muzzle, showing muzzle guard in use

the muzzle and wear them, destroying their sharpness. For this reason it is always best to provide a rifle that has to be cleaned from the muzzle with a muzzle guard. This is simply a brass cap which fits over the muzzle of the rifle. It has a hole through it slightly smaller than the bore of the rifle, through which the cleaning rod runs, see Fig. 165. The flannel patch is centered over the muzzle, and the muzzle guard slipped over the rod. Then enter the patch a short dis-

tance into the bore with the tip of the rod, slip the muzzle guard down, fitting it over the muzzle of the rifle, and one can then go ahead and scrub the bore as vigorously as he pleases, and there will be no danger of the rod rubbing the muzzle. (See Fig. 166). For cleaning in this manner it is very convenient to first insert in the chamber an empty shell which has had the muzzle plugged with a piece of wood cut off even with the muzzle of the shell. When one shoves the cleaning patch down it then does not enter the chamber, and can be easily pulled back again, scrubbing the barrel back and forth.

It is always best to clean from the breech when possible. Remove the bolt, and place the muzzle of the rifle on a small piece of board or clean chip, or piece of paper on the floor. Wet a patch thoroughly with the ammonia swabbing solution, center it over the opening of the chamber with a finger, then center the patch with the tip of the cleaning rod, push the patch into the bore, a little distance past the chamber, grasp the rod firmly, and push the patch with a steady motion down to the floor, then pull it back until it comes up to the chamber, pushing and pulling it back and forth half a dozen times thoroughly to swab and scrub the bore. (See Fig. 167). Finally push the patch out at the muzzle and discard it. Do the same with four or five other patches wet with the ammonia swabbing solution. It should require about five pounds pressure and pull to send the rod and patch back and forth through the bore. After the bore has been thoroughly swabbed with ammonia it should be scrubbed absolutely dry and clean with dry clean patches. Keep using clean patches until they come out practically clean. The second patch that one uses after the swabbing solution will usually go through very hard, and for this reason this particular patch should be slightly smaller than the others. When a clean patch run back and forth a half a dozen times comes out practically clean the cleaning of the bore has been completed. Hold the breech of the rifle up to the light (sky) and examine the bore from the muzzle to see if it is clean. If it looks bright and clean, with no spots, or flakes of dirt or metal adhering to the bore, it only remains thoroughly to swab the bore with a final patch wet with gun oil or gun grease. If one is cleaning his rifle from the muzzle it will also be necessary to clean out and oil the chamber. Then the rifle may be placed away with the assurance that it is thoroughly cleaned. All this sounds rather complicated, but in reality, once one has taken the trouble to secure all the material, it is very simple indeed, and need never take over five minutes. It is much easier, and there is very much less

labor attached to it, than if one attempts to clean with oil only, or with one of the patent powder solvents.

Usually this method of cleaning will be all that is necessary. It is well, however, to examine the rifle about the third day after cleaning.



Fig. 167

Cleaning a bolt action rifle from the breech, showing manner of using the cleaning rod

In most cases it will be found that the bore is in fine condition, and the pushing through of a clean flannel patch will bring out only clean oil. If the rifle is being used in the hunting fields the bore should be wiped out and freshly oiled every evening, even although the rifle has not been fired.

Metal fouling. The examination of the bore from the muzzle after one has finished cleaning with dry patches is very important. At this time one should look particularly for metal fouling; that is, the

heavy or lumpy metal fouling which is liable to be deposited in high power rifles having velocities over 2200 feet per second. When the bore is viewed from the muzzle this fouling looks like little flakes of metal or lead adhering to the bore, particularly on the top of the lands, for five or six inches down from the muzzle. If any of these lumps or flakes are seen adhering they should be removed at once before bad rust spots develop under them. They are too thick and heavy to be removed by the ammonia swabbing solution. Instead it is necessary to fill the bore with the ammonia metal fouling solution and allow the bore to soak for half an hour when these small flakes of metal fouling will be dissolved, and the bore can then be dried and oiled as before. This ammonia metal fouling solution is made up according to the following formula :

Ammonia persulphate	1 ounce
Ammonia carbonate	200 grains
Water	4 ounces
Stronger ammonia containing 28 per cent gas	6 ounces

Powder the first two ingredients with mortar and pestle, and dissolve in the water. When all dissolved, add the stronger ammonia. Any large druggist can make up this solution, but the rifleman usually mixes it himself. It is best kept in a large bottle having a rubber stopper such as the bottle which druggists furnish with citrate of magnesia. Keep the bottle tightly corked except when actually using the solution as it loses its strength quickly. Freshly mixed solution is best; never keep it over one month. This solution is perfectly safe to use, provided the following precautions are observed: Never use it in a rifle which is still warm from firing as rust will result almost instantly. Never allow it to dry on the bore, but wash it out and dry the bore thoroughly as soon as you pour it out of the barrel. Do not allow it to spill on the stock of the rifle as it will burn and disfigure the wood.

A rubber cork must be provided with which to cork up the breech of the barrel; cork should be just a trifle larger than the bullet. Seat it in the chamber, plugging the bore tight so that none can leak through into the action. Procure a 2-inch piece of rubber tube just large enough to slip on tight over the muzzle of the rifle. Stand the rifle, muzzle up, in a rack. If you have a long steel cleaning rod slip this into the bore as it will take up a lot of the room inside the bore and very much less solution will be used. In slipping the rod in be sure that you do not loosen the cork in the breech. Slowly and carefully pour

the ammonia metal fouling solution into the bore until it completely fills the barrel, and raises in the rubber tube on the muzzle. (The solution will evaporate a little during use, and if the tube were not present, and the bore simply filled even with the muzzle, a little would evaporate, lowering the high-water mark, and the drying of the bore at the muzzle might result in a little rust at this spot). The solution is white and clear when it is poured in. Allow it to remain in the bore for not over 30 minutes. There is no advantage, but much danger, in letting it remain longer than this. The solution does almost all its work in the first five minutes. At the end of half an hour pour out the solution. It will be a deep blue color from the copper and nickel that it has dissolved. Immediately push through one flannel patch to remove most of the solution, then scrub the bore with several patches wet with water, then follow with a number of dry, clean patches until the bore is perfectly dry and clean. Then grease the bore thoroughly and the job is finished. All the metal fouling is removed, and the rifle can be put away with perfect safety. I have cleaned rifles in this manner after a long day's shooting, then greased them thoroughly, and placed them away in a dry place, and left them entirely alone for six months. On pushing a patch through such a rifle it comes out covered with clean grease, and the bore is found to be in perfect condition.

I always used this method of cleaning with the ammonia metal fouling solution during the national matches and other military rifle competitions. At the end of the day's shooting, on arriving at my tent, I would take out the bolt of the rifle, place a cork in the breech, and a tube over the muzzle, stand the rifle in the rack, and pour the bore full of the solution from the bottle where I always kept it ready mixed. Then I would wash up and dress for mess, and then pour out the solution, clean and dry the bore in about two minutes, oil it, and the rifle was cleaned most perfectly. A rifle cleaned in this way never "sweats out" afterwards. The cleaning makes the bore chemically clean. I have one Model 1903 rifle which has been fired in competitions and practices over 5,000 rounds, and has always been cleaned in this manner. Just recently I shot twelve consecutive bull's-eyes with it at 600 yards.

This method of cleaning with the ammonia metal fouling solution is the best and safest, and I believe that it should always be used with high-power rifles in shooting on rifle ranges. It is, however, not practical in the hunting field. Happily, however, it is a fact that if the bullets be greased with Mobilubricant as described in Chapter XVIII the

rifle will not foul with this lumpy, heavy metal fouling, but only with the thin, invisible plating which can be easily removed with the ammonia swabbing solution. Therefore the hunter should grease his bullets with Mobilubricant, should carry a Spitzer greaser filled with Mobilubricant in his pocket, and his kit should contain a jointed steel cleaning rod, a waterproof bag of flannel patches, several wiping rags, the ammonia swabbing solution in a Waterman traveller's bottle made for fountain pen ink, and a can of gun oil. With such an outfit for the care of the rifle the bore can be kept in perfect condition for years. This entire kit with cleaning material enough for three months weighs a little less than two pounds, and is best kept in a little canvas roll about 9 inches long by 2 inches in diameter.

Emergency cleaning. Sometimes it happens that one cannot obtain ammonia for cleaning the bore. If this is so he usually cannot obtain any of the powder solvents or sal soda either. For emergency cleaning a brass wire bristle brush should always be carried. Make a funnel of oiled paper or birch bark, shaped so that it will fit into the chamber of the rifle. Heat a kettle of water to the boiling point. Pour the water through the bore from the breech, and then scrub it thoroughly with the brass brush. Repeat this several times, and then dry the bore and oil it. Repeat this cleaning again daily for four days after firing, but always give the rifle a good bath of the ammonia metal fouling solution when you get back where you can obtain it. In an emergency oil may be made from animals in the following manner.

“It is easy to make excellent gun oil from the fat of almost any animal. Rattlesnake oil has more body than almost any other animal oil; but that of woodchucks, squirrels, 'coons, etc., is good. A fine oil can also be made from the fat of ruffed grouse, or from the marrow of a deer's leg bones. Put the fat on a board and with a sharp knife cut it up fine; then put it in the hot sun light, or warm it gently (do not let it get hot) before a fire; now force the oil through a strong cloth bag by squeezing it. To clarify it so that it will never become viscid, put it in a bottle with a charge of shot (or shavings from the lead of a bullet), cork the bottle up, and stand it where the sun's rays will strike it. A heavy deposit will fall. Repeat, and you will then have an oil equal to that of watchmakers, but with enough body to stay where it is put, rather than running down into the chamber of the gun so as to leave unprotected spots in the barrel. A large squirrel will yield over

an ounce of tried oil, a fat woodchuck nearly a pint, and a bear several gallons — eight gallons of grease have been procured from a big grizzly.”— Horace Kephart in “Camping and Woodcraft.”

Rust. If rust appears in the bore of the rifle it should be removed at once. A very slight superficial rusting will do little harm to a rifle provided it is removed at once, and not allowed to occur again. To remove, polish the bore with a flannel patch thickly coated with Winchester Rust Remover, or make up a patch of fine steel wool and polish with it. Steel wool is long fine shavings of steel bundled together like cotton waste, and is fine for polishing steel. The polishing with either rust remover or steel wool always results in a very slight wearing away of the surface of the steel, and these materials should be used only when absolutely necessary, and never more than is necessary. If the rifle be properly cleaned, and protected from rust with a good grease or oil there will be no reason whatever for their use as rust will not form.

Care of the mechanism. The action and working parts of the rifle must be kept perfectly clean, free from dust, dirt, sand, and dampness, and should be slightly lubricated with oil or graphite. Linen cloths are excellent for cleaning the action and working parts as they absorb all dirt and old oil. A small paint brush also helps to get dirt out of crevices and cracks. Some rifles, particularly the bolt action arms, are so constructed that every part of the action can be taken apart by hand, the various parts wiped off clean, and then wiped with an oily rag before assembling. Such arms are very easy to keep clean. Ordinarily but little trouble will be experienced with the older arms which can only be taken apart with difficulty, and with the aid of screwdrivers, drift pins, etc. In ordinary use these actions close up so tightly that they accumulate little dirt, but occasionally, as after a sand storm in the desert, or a wetting in a hard rain storm, or a canoe upset, they have to be taken entirely apart and thoroughly cleaned. Chapter IV gives directions for dismounting and assembling the actions of all American rifles. The working parts should not be too heavily covered with oil as the surplus lubricant flowing to the outside will only help to collect dirt. For lubrication it is only necessary to wipe the friction surfaces off with an oily rag. Graphite lubricant is better for the bolt of a bolt action rifle as it does not flow, and stays in place on the bolt where it is needed.

The exterior of the rifle. The outside of the rifle should always be kept bright and clean. Moisture in the air, rain, and sweaty hands

all tend to produce rust. In the evening, after every day's use, the entire outside of the rifle should be wiped off to dry it with a rag, and then all the metal parts should be wiped off with an oily rag, and after this is done, when putting the rifle in its rack, do not handle the metal parts with the bare hand.

The stock. The stock ordinarily requires little attention other than to keep it clean and dry by the wiping every evening. After every rain or wetting, and about once a month it should be thoroughly polished with linseed oil by thoroughly coating it with the oil and rubbing it in with the bare hand until all the oil is rubbed in and the stock becomes quite warm. Such treatment will keep the stock in fine condition for all time. Do not use ordinary gun oil on the stock.

The gun-sling. Keep the leather gun-sling supple and in good condition by oiling it about once a month, either with neatsfoot oil, or with a solution of two parts of ordinary castor oil to one part of alcohol. Thoroughly saturate the leather with the oil, particularly on the rough side, and rub it in well with the hand. Finally leave a rather wet coating of the oil on the surface of the leather to work in and dry. Such treatment will keep the leather soft like a kid glove, and will render it waterproof.

Care of arms in cold weather. In very cold weather a rifle which has been exposed to the cold for any length of time, if then taken into a warm room, as for example a warm cabin, will condense moisture on every portion of it, inside and out. It is practically equivalent to dipping the rifle in water, and the rifle must be taken all apart, thoroughly dried, oiled, and assembled. Once this has been done the rifleman will learn in cold weather always to leave his rifle outdoors, or else to warm it so gradually that condensation does not occur. Once, at the conclusion of a long hunting trip in the West, I took a 63 mile stage trip, in zero weather, and then immediately jumped into a warm Pullman car. Fortunately I had had enough experience to know what would happen to my rifle, and an hour after getting into the train, when the rifle had warmed up, I took it out of its case and wiped the bore and exterior dry, and oiled them. On arriving home six days later I took the rifle entirely apart and gave it a thorough cleaning. Every part and piece, except the bore and exterior which had been wiped off in the train, had developed a heavy coating of rust. In very cold weather, below zero, rifles require very little attention to keep them in good shape. There is no moisture in the air at these very low temperatures, and rust does not start. If the bore and action be cleaned and lubri-

cated with a combination oil and powder solvent of the non-freezing variety like "Rem-Oil" (manufactured by the Remington Arms-U. M. C. Co.), the rifle will remain in excellent and serviceable condition in arctic weather.

Care of arms in the tropics. I have hunted and explored for a number of years in Panama which is perhaps as damp and warm a country as is found in the world. The dampness is almost beyond belief. It is a very hard climate on firearms. In my house at Culebra I had constructed a dry closet over the kitchen. In this closet an electric light was always burning, and thus it was kept fairly dry. In cleaning my rifles I always warmed and dried my flannel patches and wiping cloths over the stove first. The rifle was then thoroughly dried before it was oiled. Instead of using oil I always used one of the heavier gun greases on every part except the working portions of the action. I examined the rifles every two weeks, and occasionally found evidences of rust starting, which I quickly checked. In this manner I managed to keep all my arms in good condition during my stay of three years in this climate, except one rifle which I left in a canvas case for some months while I was away on a trip. The canvas absorbed moisture, and on my return I found this arm badly rusted on the outside.

In the jungle one perspires most profusely. The perspiration would frequently run down my shirt sleeve and directly into the action of the rifle. In the rainy season the rifle would be wet from rain, water on the vegetation, and perspiration. As a consequence it was absolutely necessary to clean and dry the rifle both inside and outside every evening when in the jungle. It was so much easier to do this with a bolt-action rifle, on account of its being possible to dismount the entire breech mechanism without tools in several seconds, that I used only this type of rifle in the jungle.

Rifle cases. Cases for the rifle should be of a material which will not absorb moisture. The best are made of very heavy waterproof canvas like Pantasote, and they should not be lined. The worst are those lined with flannel which absorb moisture and cause rust in damp climates, and which are almost impossible to dry out when they get wet. The case should be reinforced with heavy leather over those portions which cover the muzzle, sights, and action to protect them. A good sling strap should be attached.

Storage of rifles. If the rifle has to be packed away for a long time the very best and safest method is that used in the United States Army for many years. The rifles are first thoroughly cleaned and dried.

They are then very thoroughly coated on every part, inside and out, with Cosmic which is a heavy grease like cosmoline. Winchester gun-grease would do as well. The bore is almost completely filled with this grease, and it is heavily painted on all other parts with a paint brush. The rifles are then packed in arm chests of wood. In these chests the rifles are held by muzzle and butt-plate alone, the muzzles going into a hole bored in a plank at one end of the chest, and the butt-plate into a recess in a plank in the opposite end of the chest. The rifles are packed either 10 or 20 in a chest, and are so well secured therein by the fittings at muzzle and butt that they can be shipped by freight with perfect safety. Rifles thus preserved and packed will keep in perfect condition indefinitely. Rifles packed in this manner have been kept in store in the ordnance depot in Manila, in a very damp climate, for 15 years without the slightest rusting or deterioration.

Caution. In conclusion attention is called to the fact that sporting magazines frequently publish articles from men claiming to be riflemen in which the author advises cleaning the bore of the rifle with any of the patent powder solvents, or even with oil alone. A careful reading of this chapter will show that such a method in the case of a high-power rifle firing jacketed bullets is no cleaning at all. The bore is not cleaned, it is simply polished. After the first cleaning the bore will start to rust, and this rusting will continue for some days. If the rifle be cleaned again during these days of rusting the cleaning will simply consist of polishing off the rust which has accumulated. Each speck of rust takes just so much metal with it, and thus there is a steady deterioration of the arm which sooner or later will begin to show results by a decrease in the accuracy, and by a roughening and pitting of the bore.

CHAPTER XLIII

RIFLE-RANGE CONSTRUCTION

WE may classify rifle ranges into extemporized ranges, gallery ranges, and regular outdoor ranges. It is with the latter that this chapter deals; that is, with a range of 200 yards or over, requiring markers at the butts, and some form of bullet stop to catch wild shots. All such ranges have certain characteristics in common. There is a firing point, usually a level piece of ground marked by stakes; a pit in which the marker stands when marking the target, and in which the target carrier is placed; a parapet in front of the pit for the protection of the marker; and a bullet stop of some sort in rear. The combined parapet, pit, and bullet stop are usually called the "butts." Sometimes when a large body of water (lake or ocean) lies back of the butts the bullet stop can be omitted.

The size and general character of the range will depend upon the number of men who are going to use it, and whether it is to be used for military work requiring long ranges, or by a civilian club which may require a distance up to 200 yards only. In some cases future expansion must be considered. Besides these matters we have one other very serious matter to consider in the location of a rifle range, namely the safety. A rifle range is absolutely safe only when all the space in rear of the butts for the extreme range of the rifle is controlled or owned by the range authorities. Such a site can almost never be obtained. In most localities it is not difficult to find ground on which a range can be built which will be safe from all but accidental shots. Thus a bullet stop thrown up immediately behind the targets, and extending 20 feet above them, on a rifle range up to 600 yards, should catch 99.99 per cent. of all the shots. Such a bullet stop should be faced with sand or clear earth at as steep a slope as it will stand. For a private club range of 200 yards a bullet stop 10 feet above the targets will usually suffice. Both these cases presuppose that the land in rear is sparsely settled. Neither of them would be safe enough to take a chance on with a city street a few hundred yards in rear. A hill for bullet stop must be quite high to catch ricochets, etc., or if of medium height one may chance it if there be no rocks on the surface to cause

ricochets, and the ground in rear of the target be quite steep. Ploughing and terracing helps to make a hill safer. It is possible to make a range quite safe by erecting a steel-faced bulkhead a short distance in front of the firing point as shown in Fig. 168. The bulkhead catches all high shots which would go over the bullet stop.

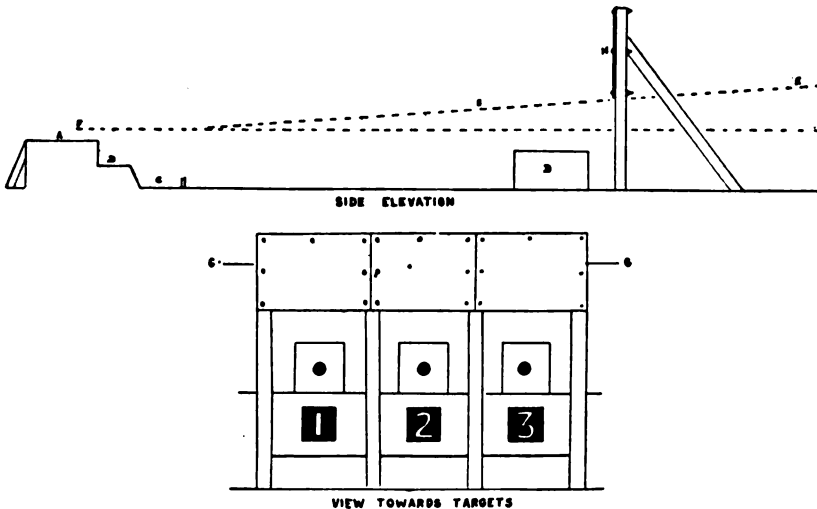

Fig. 168

Safety bulkhead construction

- A — Prone firing point.
- B — Kneeling and sitting firing point.
- C — Standing firing point.
- D — Bullet stop filled with sand to catch shots which would ricochet on ground.
- E — Line connecting eye of man 5 feet tall in firing position with point 2 feet below top of bullet stop at butts.
- F — Line of normal fire.
- G — Top of bullet stop behind target pit, or top of hill.
- H — $\frac{3}{4}$ -inch steel plate, 4 feet high, on supports of 6" x 6" timbers, placed 50 feet in front of firing point.

The location of a rifle range with respect to safety usually involves taking some sort of a chance. The risk should be very small. On one military range which has been in use for about 50 years there is a sand bank bullet stop carried up 20 feet above the top of the targets, and immediately behind them. This range is used up to 600 yards with 50 targets. On an average about 25 shots go over the top of the bullet stop during an entire day's firing, all targets running. By far the larger percentage of these overs are ricochets from the top of the parapet and ground between the firing point and target. A mile and a half in rear of the butts is a country road, but no farm houses in direct

line of fire. Once or twice a season a farmer driving along this road will hear a bullet flying overhead. The board of trade in a near-by town looks out that there shall be no injunctions. This is a case where a range is not absolutely safe, but so nearly so that the chance can be taken.

Where possible a range should always face the north so that the sun will shine on the targets during the whole day, and not in the

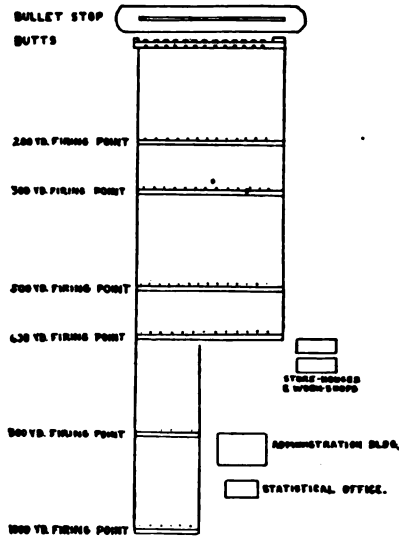

Fig. 169

Layout of rifle range with single butt, and firing points one behind the other eyes of the shooters. If this is not possible, then a military range should face west so that the sun will be on the targets during the morning when most military shooting is done, and for similar reasons the civilian club range had better face the east.

As regards layout there are two general types of ranges, those with a single butt, and the firing points one behind the other, and the echelon range where the butts are in echelon, and the firing points all in one straight line. Typical layouts of these two types are shown in Figures 169 and 170. Where the location affords the necessary space in width, and the extra butt construction can be afforded, the echelon system is far preferable. Men can be shooting at each range at the same time. In competitions or the practice of a number of men, when one man is through at a certain range he does not have to wait for every one else

to complete at that range before going back to the longer range, but can start in at the next range right away.

Modern butt construction is a simple matter, although one which involves quite an amount of labor. The type of butt is always the same. There must be a parapet which adequately protects the marker, there

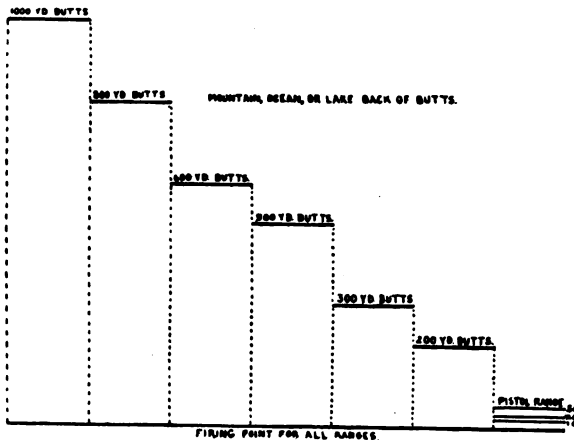

Fig. 170

Layout of target range, butts in echelon, and one continuous firing point

must be a target carrier which raises the paper target up over the parapet for firing, and which lowers it into the pit for pasting, the pit must be drained, and it is desirable that there be telephone communication between the firing point and the pit. Fig. 171 shows a number of types on various kinds of ground. The type on the side hill is the most expensive to build. The one with the parapet entirely above the level of the ground is used on land where the water level is high, or where it is swampy. If a bullet stop has to be built, it adds a lot to the cost of construction.

Fig. 172 is a working drawing of a modern target pit, all the measurements being given. This is constructed for one of the modern steel target carriers which are very much the best if they can be afforded. The revetment, that is, the wall which holds up the inside wall of the parapet, may be either of stone set in concrete, of concrete, brick, or of 2-inch wood planks with uprights 6 inches square spaced every 3 feet. If of wood the uprights must either be securely anchored back into the parapet, or what is better, braced against a bank on the back side of the pit by cross pieces run across at the top of the pit between the target carriers.

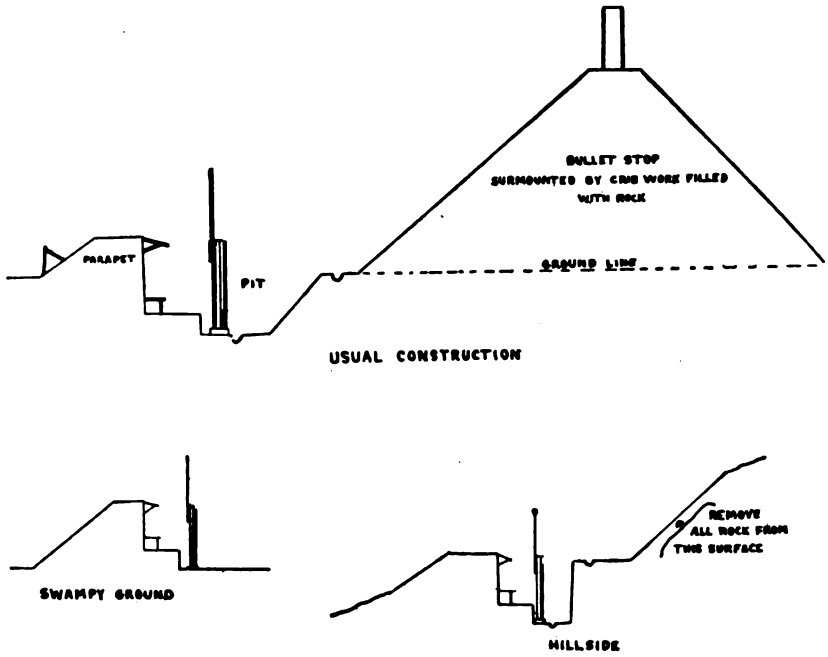
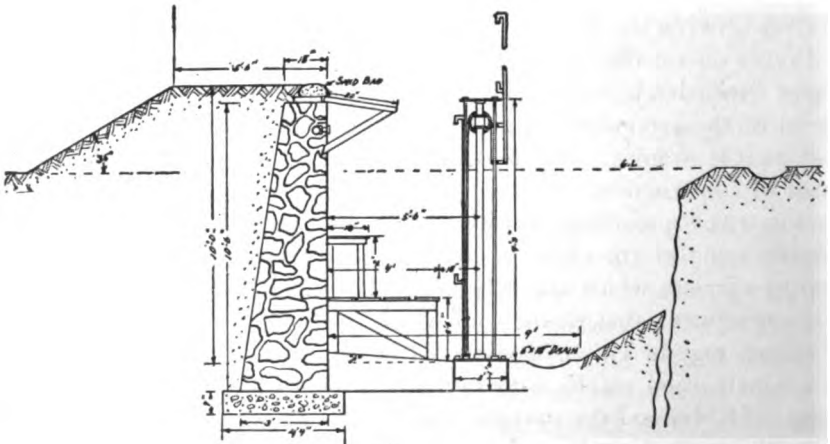

Fig. 171
Showing construction of butts on various sites



Profile of rifle range butt, showing construction. Dimensions correct for commercial steel target carrier

Very often one can extemporize material from which to construct the butt. At Culebra, Panama, I built a large rifle range with what material I could pick up on the dump of the Panama Canal. The revetment was made of old railroad ties and old galvanized iron taken from the roofs of old shacks along the railroad. The upright railroad ties were anchored back into the revetment by means of wire cable made by twisting many strands of old telegraph wire and barbed wire. Notwithstanding the fact that many of the ties were rotting when put in place this range has stood for four years, and is still practically as

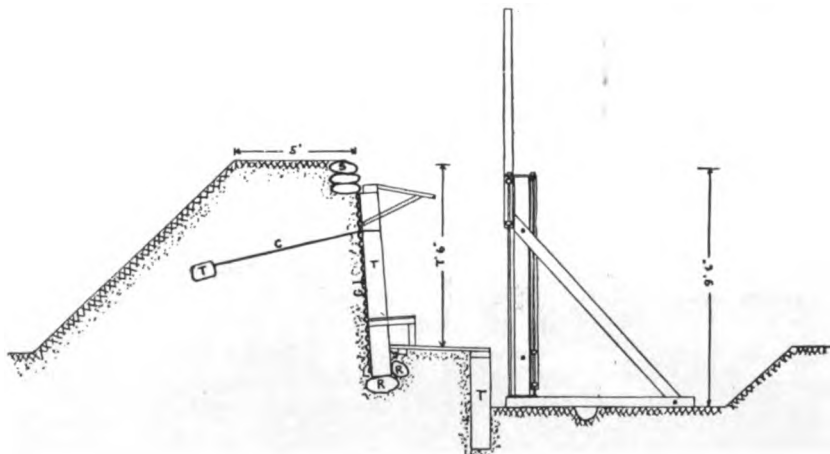

Fig. 173

Butt constructed at Camp Gaillard, Panama Canal Zone, of scrap material.

Measurements are correct for U. S. Army wood frame target carrier

T T T — Old railroad ties.

GI — Old galvanized iron roofing.

C — Wire cable made of old telegraph wire.

R R — Rocks.

S — Sand bags.

sound as when new. It was built at a cost of \$36, not including the labor of the troops who built it. Fig. 173 shows the design and construction, it being fitted for the regular United States Army target carried which has a framework of wood. The dimensions show the correct size of the pit for this type of carriage.

In all pits the parapet should be at least 5 feet wide on top. Three feet in almost any soil is wide enough to stop any bullet, but the crest just below the targets gets cut away after a time by the bullets, and before a five-foot top is cut away to a dangerous extent the hole will show so clearly that one will be sure to have it repaired. The interior

crest must always be crowned with a layer of sand-bags, that is, with gunny sacks or concrete sacks filled with sand or with dirt free from rocks and pebbles. If this is not done there is always danger of a bullet some time striking the underside of a rock or pebble on the top of the parapet and being deflected down into the pit. I have seen two men killed by accidents of this kind, but such accidents have never occurred on ranges where the crest of the parapet has been crowned with bags filled with sand or clean earth.

Where the butts contain a number of target carriers there should always be a latrine in the butt for the use of the markers, and at one

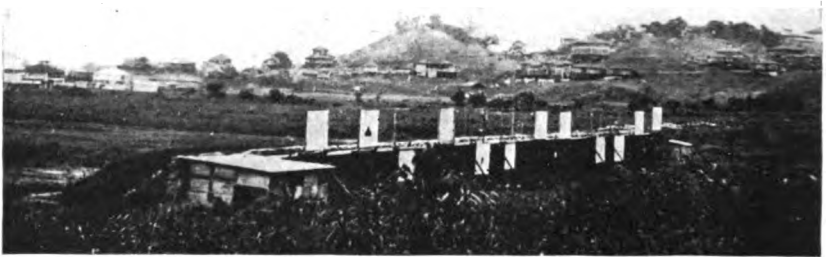

Fig. 174

The target butts constructed at Camp Gaillard, Panama Canal Zone, by the author entirely from scrap material

end of the butt there should be a small house or shed for the protection of the targets that are being used from day to day. The distance between targets should be not less than four feet for 200 and 300 yards, and not less than six feet for 500 and 600 yards. Each target should be numbered by a large wooden number standing on the front face of the parapet below the target. It is best to place this number a little low if possible so that there will be about a foot of dirt on the parapet visible between the bottom of the target and the top of the number board, otherwise the number boards will be shot away very quickly. If the parapet is not of sufficient height to allow the placing of the numbers below the targets they must be placed above, either on the bullet stop, or on a wire strung along over the targets. For two and three hundred yards the numbers should be 2 to 3 feet high, for 500 and 600 yards 5 feet high, and for 1000 yards eight feet high. If the

background on the board be painted black and the numbers white they can be seen most distinctly. Fig. 175 shows a plan of a butt containing eight targets. The parapet must be such a height with relation to the carriage that there is absolutely no danger of a bullet passing over the top striking any of the metal parts of the carriage and being deflected down into the pit. Examine for this particularly when the range is first built, and again every six months. I have known the whole parapet of a range to settle eight inches in three months and make it absolutely unsafe for this reason. To find the correct height of the parapet, have a target placed in the carriage, and have the target run up to its full height. Go behind the target and sight just under the lower edge of the target at the firing point. The parapet should be brought up to the line joining the lower edge of the target and the firing point. The parapet should also extend at least $7\frac{1}{2}$ feet above the bench or plat-

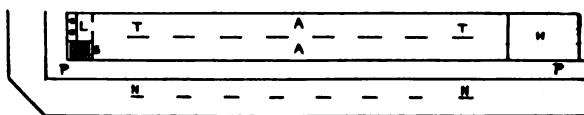

Fig. 175

Plan of butt for eight targets

A-A — Pit.

P-P — Parapet.

N-N — Numbers.

H — Target house, 18 x 12 feet with doors at each end, roof below parapet top.

L — Latrine.

S — Steps leading to top of parapet.

form on which the markers stand when marking the targets. The little shed roof over a portion of the pit has two uses, it shelters the markers from the hot sun, and from dirt and gravel which occasionally falls into the pit, and it also prevents fools from standing up on the seats and sticking their heads up over the parapet.

The very best system of marking the targets is by means of spotters and marking disks arranged at the side of the target. A bull's-eye (5) is signalled by displaying a circular white disk, a four by a red disk, a three by a white disk with a black cross on it, and a two by means of a black disk. Most military ranges are provided with these disks on a pole. There is a disk on each end of the pole, each disk being painted a separate color. When the shot strikes the target, the marker is supposed to pull the target which has been fired upon down into the pit, at the same time the target on the opposite carriage rising into the

firing position. The marker notes where the bullet has struck the target which has just been lowered and reaching up with the pole he displays the proper colored disk, placing it with its center over that portion of the upper target where the rifleman has struck the lower target. This system is far from satisfactory. It does not indicate to the rifleman with any surety exactly where he has struck the target, it is slow, and it is very tiring on the marker; also it requires at least two men to mark a target with any degree of rapidity. Instead, almost all rifle ranges are now arranged with a little framework alongside the target carrier, but below the crest of the parapet. The pole of the marking disk is cut in half, and the halves stuck in the framework as shown in Fig. 176. Normally the disks are set with their edge towards the firing point. When it is desired to indicate the value of a hit it is only necessary for the marker to reach up and give the proper pole a turn so that the proper disk shows with its face towards the firing point. To indicate the exact location of the hit on the target, spotters are provided. These are circular disks of cardboard, $2\frac{1}{2}$ inches in diameter for 200 yards, 5 inches in diameter for 600 yards, and 8 inches in diameter for 1000 yards. They are painted black on one side and white on the other. The black surface is used to indicate a hit on the white surface of the target, and the white side to indicate a hit in the bull's-eye. Through the center of the spotting disk runs a wire which is hooked into the bullet hole. In marking with this system, but one target is used on a carrier, the rear carriage having a dummy weight attached to it so that the carrier will balance and run smoothly. When the target is struck the marker pulls the target down, takes out the old spotter and pastes up that hole, notes where the bullet has struck, places a spotter in the new bullet hole, runs the target up into place again, and then turns the marking disk at the side of the target so as to display the right signal to the firing point. The signal is allowed to stay in view for about 30 seconds and is then brought back with its edge towards the firing point. At the firing point the scorer sees the large disk displayed alongside the target and records the value of the hit. The rifleman with his telescope or field glasses, or even with his naked eye, sees the spotter sticking in his last bullet hole, and knows to within an inch of where he has struck the target. This is a very satisfactory system, and is the one in use at the national matches. Of course this method cannot be used in rapid fire, the method there being the same as that prescribed in the "Small Arms Firing Manual" of the Army.

The paper target is pasted on a wood frame covered with muslin, the sides of this frame are extended below the square portion to form legs. These legs are stuck in iron holders provided for them in the sliding carriages of the target carriers. In order to have the paper target present a good appearance, remain secure on the frame, and have its

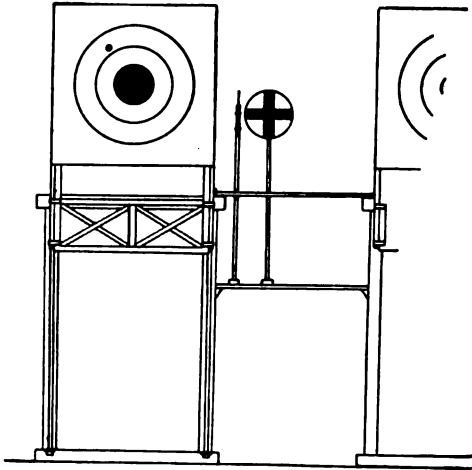

Fig. 176

Modern method of marking the military target. A "three" has just been spotted and disked

true shape and dimensions, it is necessary that some pains be taken about pasting it on the frame. The muslin on the frame must be smoothly and tightly tacked on. Certain concerns make target paste, but this is never better, and much more expensive than well-made flour paste. To make flour paste for pasting targets and for sticking on pasters, proceed as follows: Use an ordinary galvanized iron bucket which holds 12 quarts. In this place 2 quarts of flour, and pour in a little cold water gradually, stirring all the time until the flour is all wet and the lumps are broken up, making a rather thin dough. Then pour in boiling water, stirring rapidly. It is necessary that the water be boiling hot, and that the paste be stirred very briskly. Don't fill absolutely up to the top with the boiling water as the paste swells as soon as the boiling water is poured in and the stirring started. Don't make more paste than is needed at one time as it sours in a few days. If it gets too thick at any time it can be thinned down with a little cold water. To keep rats from gnawing the targets, put a tablespoon-

ful of concentrated lye dissolved in a point of water to each 12-quart bucket of paste.

To paste the target on the frame, have the target frame with muslin tightly tacked and stretched, on a table provided for this purpose. The top of the table should be just the size of the inside of the frame with an edging around the top but an inch below it, so that when the frame is placed on the table top the muslin will be supported by the top, and the frame setting down over the top will be supported by the edging strip. Using a whitewash brush, put paste thickly but evenly all over the back of the target, and then fold from each end to the center, thus bringing pasted surfaces together, and place the target aside for a few minutes. This will allow the paste to soak into the paper target. Then paste the muslin on the target frame getting the coat on evenly. Now open up the paper target and put it on the frame, getting it started square and brushing out all the wrinkles with a clean whitewash brush. See that all the edges of the target are securely pasted down. When this target dries it will be perfectly smooth and even, and it will stay on in any wind, and in any rain but the very heaviest.

Pasters are best provided without any paste at all on them. Square ones are the cheapest, they usually come in perforated sheets like postage stamps, about an inch square, 100 to a sheet. About 75 per cent. should be white and the other 25 per cent. black. The marker should be provided with a small board about eight inches square, a small can of paste, and a number of pasters. He places a thick coat of paste on the board, and on it places a number of black and white pasters. The paste is placed on the board thick enough to stay wet all the time. When he pastes up a bullet hole he simply slides a paster off the board and sticks it over the bullet hole. He should take pains when pasting around the edge of the bull's-eye to preserve the outline of the bull as perfectly as possible.

CHAPTER XLIV

THE NATIONAL RIFLE ASSOCIATION OF AMERICA

FOR the purpose of promoting skill in military rifle shooting, an art which until that time had remained largely undeveloped, the National Rifle Association of America was formed November 24, 1871, with General A. E. Burnside as president; Colonel William C. Church, vice-president; General John B. Woodward, treasurer; and General George W. Wingate, secretary. The Creedmore rifle range, which has been so closely associated with the early history of military rifle shooting in this country, was obtained a year later, purchased by joint contributions from the State of New York, and the boroughs of Brooklyn and New York City, and laid out following a visit to the English range at Wimbledon and the Canadian ranges by the committee who had the matter in charge.

During the first few years of the National Rifle Association's existence several clubs were former and affiliated with it, and the first meeting at the Creedmoor range was held June 21, 1873. In this contest there were entered as contestants most of the New York National Guard organizations, the United States Engineers, and a squad of Regulars from Governor's Island. Affiliated with the N. R. A. at that time was the club known as the Amateur Rifle Club, an organization formed to promote long range shooting. It was this club which initiated the movement which led to the holding of the first international long range rifle match at Creedmore in the fall of 1874.

During the quarter century which followed, the National Rifle Association continued the work of encouraging rifle practice, but one by one the principal members died, until early in 1900 there was talk of organizing a new association of riflemen. Plans for the new organization were discussed at a convention of riflemen held at the Sea Girt competitions during August and September of that year. Following this convention it was found practical, with the co-operation of the surviving members of the original association, to perfect a reorganization of the parent body, and on December 17, 1900, Brigadier-General Bird W. Spencer of New Jersey was elected president.

Upon the reorganization, steps were at once taken to boom rifle practice. Annual competitions were revived, and invitations were sent to

foreign countries to participate in a match for the Palma trophy. This trophy, emblematic of the world's championship, was the gift of American citizens. The conditions laid down for this match called for 15 shots at 800, 900, and 1000 yards, 36-inch bull's-eye, four ring, 53 inches in diameter, military rifles to be used, conditions which pertain in this match to the present day. The first of these annual competitions was conducted at Sea Girt, New Jersey, August 30 to September 7, 1901, on the occasion of the twenty-ninth annual meeting of the association. Nine state teams, a team from the United States Marine Corps, a Canadian team to compete in the Palma match, and a team from the Ulster Rifle Association of Ireland to compete in an Irish-American match similar to the Palma, were entered. In addition to these matches there were competitions for several trophies which are familiar to the riflemen of today, including the Wimbledon Cup, the Soldier of Marathon, and the Hilton Trophy, the latter two having been donated by the National Rifle Association. In the international matches the Canadian and Irish teams were victorious over the Americans. Cash entry fees were charged in the matches, and part of the money returned as prizes, a practice which obtained in the association until 1917, when cash prizes were abolished.

During this meeting plans were set on foot to persuade Congress to provide a suitable trophy for a national match, in which all the services, as well as the National Guard teams, were to compete annually. On May 21, 1902, Representative Mondell of Wyoming reported from the committee on military affairs of the House of Representatives the bill which resulted in the establishment of the national matches. At the national matches of 1902, held at Sea Girt, New Jersey, from August 29 to September 6, fourteen state teams, two army teams, and a Marine Corps team competed, and there were 6841 entries in the individual matches.

Concerning itself with the conduct of the annual matches of the association, and with campaigns to place military arms within the reach of civilians, the National Rifle Association continued its work, and met with marked success. In 1903 a team of American riflemen was sent to England to compete for the Palma trophy won by the Canadians in 1901. This competition resulted in the winning of the match by the American team at Bisley, England, on July 1, 1903, and acted as a great stimulus to rifle practice in this country. Other efforts resulted in adding to the national matches a national individual rifle match, and a national individual pistol match.

About this time the National Board for the Promotion of Rifle Practice was formed in the War Department, and action was taken by that body to constitute the National Rifle Association its agent in engendering an interest in rifle shooting among the citizens of the country. From this resulted the government rifle clubs affiliated with the National Rifle Association. Members of these clubs, when shooting rifles capable of using government cartridges, and fitted with service sights, were permitted to shoot record scores and were granted marksmanship decorations by the War Department. At the beginning of 1904 the National Board also drew up sweeping plans for the promotion of rifle practice, and turned them over to the National Rifle Association to carry out. These plans included a change in the courses of fire for the national team match, the national individual match, and the national pistol match.

During the decade between 1904 and 1914 vast strides were made in rifle practice in the United States. At the close of 1913, 157 civilian rifle clubs were affiliated with the association, with a total membership of 6193. Authorization was also obtained for the sale of military arms to rifle clubs and to members of the National Rifle Association. However, the real development of the association was destined to come during the year 1914 when Congress passed legislation authorizing the free issue of Krag rifles and ammunition therefor to civilian rifle clubs. In this year there were organized 270 clubs with a membership of 10,077. Of these members 304 qualified as expert riflemen, 133 as sharpshooters and 151 as marksmen. College clubs had been established and affiliated, and of these 45 members qualified as experts, 66 as sharpshooters, and 66 as marksmen.

With the annual meeting of 1916, when Colonel William Libbey of Princeton, New Jersey, was re-elected as president, and Brigadier-General Fred H. Phillips, Jr., of Tennessee was named secretary, the greatest period of development began. During this year Congress appropriated \$300,000 for the promotion of rifle practice, and the 1916 national matches were the largest ever staged. These matches marked the entry of civilian teams into active competition on a par with the military teams. Early in 1918 there were more than 2000 civilian rifle clubs in the United States duly affiliated with the National Rifle Association, having an aggregate membership in excess of 100,000.

The chief activities of the association at present, in addition to conducting its regular program of competitions, organizing rifle clubs, and acting as agent for the National Board for the Promotion of Rifle Prac-

tice, is the training of men subject to draft, in rifle practice. Since the outbreak of the war most of the civilian rifle clubs have voluntarily thrown open their ranges to these men and although unable at present to obtain government rifles and ammunition—the issue and purchase privilege having been temporarily suspended owing to the demand for war purposes—they have sent thousands of men into service with a thorough knowledge of the service rifle.

Under the law passed in 1914 every rifle club was permitted to draw, on the free issue, one Krag rifle for every five members of the club. For these rifles the Government furnished 120 rounds of ammunition per member per year. When qualifying scores are made by rifle club members they are granted government decorations—expert rifleman, sharpshooter, and marksman. In addition to this the law permits any rifle club member to purchase from the Government a Springfield or Krag rifle, title to pass to the member upon his qualification as a sharpshooter or better. As stated, this latter privilege has been temporarily suspended as a war measure, but the indications are that it will be restored shortly.

At present (April, 1918) the regulations for the establishment of indoor and outdoor ranges read as follows:

REGULATIONS FOR CARRYING INTO EFFECT THE PROVISIONS OF SECTION
113 OF THE NATIONAL DEFENSE ACT OF JUNE 3, 1916

1. Section 113 of the Defense Act of June 3, 1916.

“The Secretary of War shall annually submit to Congress recommendations and estimates for the establishment and maintenance of indoor and outdoor rifle ranges, under such a comprehensive plan as will ultimately result in providing adequate facilities for rifle practice in all sections of the country. And that all ranges so established and all ranges which may have already been constructed, in whole or in part, with funds provided by Congress shall be open for use by those in any branch of the military or naval service of the United States, and by all able-bodied males capable of bearing arms, under reasonable regulations to be prescribed by the controlling authorities and approved by the Secretary of War. That the President may detail capable officers and noncommissioned officers of the Regular Army and National Guard to duty at such ranges as instructors for the purpose of training the citizenry in the use of the military arm. Where rifle ranges shall have been so established and instructors assigned to duty thereat, the Secretary of War shall be authorized to provide for the issue of a rea-

sonable number of standard military rifles and such quantities of ammunition as may be available for use in conducting such rifle practice."

Regulations

In so far as practicable, the appropriations made to carry out the provisions of Section 113 of the Act will be used for the establishment of adequate facilities for rifle practice of all able-bodied male citizens of the United States capable of bearing arms.

2. Target facilities will be made available only to physically fit males between the ages of 16 and 45, who are citizens of the United States.

3. No part of the moneys appropriated by Congress to establish and maintain indoor and outdoor rifle ranges and for the transportation of persons to participate in target practice, shall be expended in providing facilities for or participation in, target practice upon persons who are unfitted by age or physical condition or for any other reason, to bear arms in defense of their country.

4. Such parts of appropriations as may be allotted by the Secretary of War for the following purposes will be expended under the direction of the Director of Civilian Marksmanship, who is authorized to make use of the National Rifle Association of America as an agency for establishing and maintaining indoor and outdoor ranges and instructing the citizens of the United States in marksmanship.

(a) For the employment of labor and purchase of material in connection with the establishment of indoor and outdoor rifle ranges, including labor in operating targets.

(b) For the expenses and employment of instructors at schools for the training of civilians as instructors, and for expenses and employment of instructors at outdoor and indoor ranges for training of civilians.

(c) For prizes, except cash prizes, trophies, badges, and other insignia.

(d) For the transportation of employees, instructors, and civilians to engage in target practice.

(e) For the purchase of materials, supplies, and services incidental to instruction in marksmanship of citizens of the United States.

(f) For clerical services.

(g) For expenses incidental to instructions of citizens of the United States in marksmanship.

5. Instructors will be assigned from officers and enlisted men of the Army of the United States, the National Guard, and civilians, at out-

door and indoor ranges as recommended by the Director of Civilian Marksmanship on approval of the Secretary of War.

6. The establishment of new indoor and outdoor rifle ranges will be made only after approval by the Secretary of War in each particular case.

7. Regulations for the use of rifle ranges for civilian instruction which have been constructed or may hereafter be constructed in whole or in part from funds appropriated by Congress as prescribed by Section 113, Act of June 3, 1916, shall be prepared by the Director of Civilian Marksmanship.

8. To establish local indoor and outdoor rifle ranges for the use of members of rifle clubs, the Ordnance Department will issue, in so far as appropriations will permit and on approval of the Director of Civilian Marksmanship, to rifle clubs organized under the rules of the National Board for the Promotion of Rifle Practice, ammunition, rifles, targets, target materials, and other accessories not more than the following:

Initial Issue

2 U. S. rifles, caliber .30, Model 1903 or 1917, and accessories.

2 rifles, caliber .22, and accessories.

1 outdoor target carrier.

2 outdoor target carriers.

1 disk, marking and staff, middle range.

1 disk, marking and staff, short range.

1 flag, danger.

1 flag, ricochet.

Annual Issue

120 ball cartridges, caliber .30, for each member who during the previous target year qualified as marksman or better.

200 ball cartridges, caliber .22, for each member, but not exceeding 20,000 to any club.

100 targets, A, B, D, or E.

1000 targets, gallery.

10,000 pasters.

6 spotters, short range.

6 spotters, mid range.

10 yards target cloth.

And such material as in the opinion of the Director of Civilian Marksmanship is essential to the promotion of rifle practice in high schools.

9. The Director of Civilian Marksmanship will collect data and submit to the Secretary of War annually estimates for the purchases of described tracts of land for the establishment of rifle ranges with the ultimate purpose of providing in each State one principal range and such other ranges as are necessary.

10. The Director of Civilian Marksmanship will consider the advisability of tracts of land already owned or leased by the Federal Government and will recommend to the Secretary of War the establishment of rifle ranges on such tracts or parts of tracts as are available, suitable, and needed for the purpose from any appropriation available or from future appropriations and shall recommend annual estimates within the purview of this item.

11. The Director of Civilian Marksmanship will prepare for the approval of the Secretary of War and put in operation plans for the training of civilians to act as instructors in marksmanship; for their appointment as such after proper evidence of qualification.

12. Systematic programs shall be prepared by the Director of Civilian Marksmanship. In general, these programs will be so formed as to develop a wide participation in rifle practice by prescribing (a) through individual instruction, (b) local competition leading up to (c) State or district competitions, from which will be selected the civilian competitors and teams that compete in (d) the National Matches.

Since the free issue of government rifles and ammunition has been suspended, many of the clubs have turned to the .22-caliber miniature rifle. These rifles have proved satisfactory for outdoor use up to 250 yards, and the rifles and their ammunition is so cheap that they come within the means of the clubs. Qualification scores with this arm are now recognized in outdoor shooting, the course being a reduced National Guard course calling for shooting between 50 and 250 yards on targets reduced to proper proportions.

Every rifleman, whether he be a military man or a civilian, a sportsman, hunter, or just plain rifle crank, should join the National Rifle Association as an individual member. There are many advantages which accrue from membership, such as the privilege of purchase of government arms and ammunition at cost (by life members), the privilege of qualification and decoration, the keeping in touch with modern methods and equipment. In addition every rifleman who is located within reach of a civilian rifle club affiliated with the National Rifle Association should become a member of the club, thereby ob-

taining the use of a good rifle range, the privilege of entering the various competitions, the use of the club arms and ammunition, and all the advantages that come from mingling with other riflemen. All information in regard to individual membership, the formation of civilian rifle clubs, and the address of the nearest club can be obtained by addressing Brigadier-General Fred H. Phillips, Jr., secretary, National Rifle Association of America, Woodward Building, Washington, D. C.

INDEX

A

Abel, Sir Frederic, 286
Accuracy, 382
 definition of, 382
Accuracy life, 403
Adjustment of rifle, 432
Adjustment of sight, 170, 456, 492
Adolph double-barrel rifle, 316, 326
Adolph combination rifle and shotgun,
 140, 314
Adolph-Springfield rifle, 185
Aiming, 455, 458.
Aiming bar, 462
Aiming exercise, 464
Aiming drills, 501
Alignment of sights, 148, 458
Alloys of lead and tin, 352
Ammonia metal fouling solution, 607
Ammonia swabbing solution, 603
Angle of departure, 18
Angle of elevation, 18
Angle of fall, 18
Anti-corro steel, 130

B

Bag, shooting, 516
Baker, Sir Samuel, 364
Balance, 143
Ballard rifle, 14
Ballistite powder, 286
Barometer, 378, 522
Barrel flip, 411
Barrels, 130
Barrels, heavy, 413
 straightened, 390
Beads, sight, 151
Black, for sights, 515
Bore, measurement of, 446
 sighting, 411
 size of in relation to accuracy, 391
 spiral, 387
Box, patch, 4
 for resting rifle, 464
Brass deterioration in shells, 210
Breech block, 16
Breech bolt, 16
Breech pressure (see also under each
 cartridge), 392
Broken shell extractors, 443

Brunswick rifle, 7
Bullet imperfections, 388
Bullet stop, 614
Bullets, 16, 197
 expansion on game, 205
 gyration of, 386
 oscillation of, 386
 tipping, 385
 unbalanced, 386
 weight of for accuracy, 401
Butts, target, 614
Butt-plates, 141

C

Caliber, 15
Calling the shot, 456, 490
Cartridges:
 .22 short, 211, 371
 .22 long rifle, 212, 371
 .22 Winchester rim fire, 216, 371
 .22 Savage high power, 217, 371
 .25 Stevens rim fire, 219, 371
 .25-20 W. C. F., 220, 371
 .25-20 single shot, 224, 371
 .25-21 Stevens, 226, 371
 .25-25 Stevens, 226, 371
 .25-35 W. C. F., 227, 371
 .25-36 Marlin, 229, 371
 .25 Remington auto-loading, 230, 371
 .250-3000 Savage, 232, 371
 .256 Newton high power, 234
 .28-30 Stevens, 236, 371
 .280 Ross, 237
 .30-30 W. C. F., 170, 239, 370, 372
 .30 Remington auto-loading, 239, 371
 .30-40 U. S. Model 1898, 209, 244,
 362, 370, 372
 .30 U. S. Model 1906, 120, 209, 249,
 363, 370
 .30 Newton high power, 253
 .303 Savage, 242, 370
 .32-20 W. C. F., 255
 .32 Winchester self-loading, 257
 .32-40, 258, 371
 .32 Winchester Special, 261, 370
 .32 Remington auto-loading, 262, 370
 .33 W. C. F., 263, 370, 372
 .35 Winchester self-loading, 265
 .351 Winchester self-loading, 266, 371
 .35 Remington auto-loading, 267

Cartridges — *continued*

- .35 W. C. F. Model, 1895, 268, 370
- .38-40 W. C. F., 269
- .38-55, 271, 371
- .401 Winchester self-loading, 274, 371
- .405 W. C. F. Model, 1895, 275, 370, 372
- .44-40 W. C. F., 277, 371
- .45-70 U. S. Government, 278, 370
- .45-90 W. C. F., 282, 370
- 6½ mm. Mannlicher, 370
- 8 mm. Mauser, 370.
- 9 mm. Mauser, 370

Cartridges, nomenclature of, 22

- Cases for rifles, 612
- Cast off, 141
- Center of impact, 18
- Chamber, 16, 393
- Chambers, very tight, 398
 - Mann-Neidner, 398
- Checking on stocks, 137, 439
- Cheek-piece, 142
- Chronograph, 383
- Civilian rifle practice regulations, 629
- Classification of rifles, 21
- Cleaning from the breech, 604
- Cleaning the bore, 598
- Cleaning in emergency, 609
- Cleaning kit for hunting, 590
- Cleaning materials, 519, 590
- Cleaning from the muzzle, 604
- Cleaning the rifle, 598
- Cleaning rod, 601
- Cleaning shells, 357
- Cleaning in the wilderness, 590
- Clothing for shooting, 514
- Cold, care of rifles in, 611
- Comb of stock, 138
- Competitions, 546, 625
- Cordite powder, 286
- Crimping shells, 346
- Crossman, E. C., rifle of, 582
- Crossman system of rapid fire, 583
- Culebra, target range at, 619

D

- Deer, running target, 585
- Dillon, John, 5
- Dimensions of stocks, 138
- Dipper for moulding bullets, 350
- Dope bag, 516
- Du Pont, Francis G., 287

E

- Elevation, 374, 520
 - big game, 375

Elevation — *continued*

- grouse, 574
- normal, 381
- open ground, 574
- woods, 574
- zero, 411, 571
- Energy, 18, 369, 372
- Enfield rifle (U. S. Model 1917), 122
- Equipment for outdoor range shooting, 514
- Erosion, 395
- Expert rifleman, 544
- Extracting broken shells, 443

F

- Fall of bullet, 17
- Firing pin, 16
- Flip of barrel, 135
- Foot-pounds, 369, 372
- Forearms, 143
- Forsyth, Alexander J., 7
- Front sights, 151

G

- Game shooting, 590
- Gaillard, Camp, target range at, 619
- Gallery experiments, 511
- Gallery ranges, construction of, 506
- Gallery rifles, 509
- Gallery shooting, 505
- Gas cutting, 395
- Glasses, shooting, 519
- Globe sights, 514
- Goulcher muzzle loading rifle, 6
- Grooves, 15
- Group, 18
- Group measurement, 428
- Group, normal, 384
- Gun-sling, care of, 611
 - construction of, 475
 - use of, 475
- Gyration of bullets, 386
- Gyrostatic stability, 16

H

- Hawken muzzle loading rifles, 4
- Heel of butt, 138
- Henry rifle, 9, 10
- Holding the rifle, 455, 466
- Horn, powder, 4
- Hygrometer, 378

I

- Ideal handbook, 358
- Ideal reloading tools, 340

K

Kellner, Gaspard, 3
 Kentucky rifle, 7
 Kephart, Horace, 361
 Kick, 18, 579
 Killing powder, 364
 Kit, cleaning, for hunting, 590
 Krag-Jorgensen rifle, 13, 101, 323, 391

L

Lands, 15
 Large bore rifles, definition of, 21
 Lee-Enfield rifle, 13, 122
 Leopold, E. A., 559
 Lever action rifles, 21
 Libbey, Colonel William, 627
 Light, 378, 522
 London oil finish, 137
 Lyman sights, 161
 Lubricating bullets, 356

M

Machine rests, 425, 560
 Mainspring, 16
 Mann, Dr. F. W., 559
 Mann taper dovetail mounts, 189
 Manual, Small Arms Firing, 543
 Marble sights, 164
 Marking, system of target, 621
 Marksman, 544
 Marksmanship, A. B. C. of, 455
 Marlin rifles, Models of 1893, 1894,
 and 1895, 85
 .22 cal. Model 1897, 88
 Matches, National, 552
 Mauser, rifle action, 24
 Maxims for still hunter, 596
 McDougal, Captain D. C., 409
 Measure of accuracy, 18
 Measurement of targets, 428
 Mechanism, care of, 621
 Metal fouling, 377, 403, 606
 Metal fouling solution, 607
 Micrometer sight adjuster, 498, 517
 Military rifle shooting, 543
 Military targets, 550
 Minutes of angle, 175
 Mirage, 378, 522
 Mobilubricant, 403, 516
 Moul, bullet, 350
 sulphur, 448
 Moulding bullets, 350
 Moving objects, shooting at, 584
 Moving targets, 585
 Muzzle and elbow rest, 562
 Muzzle, damage and wear to, 376

Muzzle guard, 601, 604
 Muzzle loading rifles, 2
 Muzzle wear, 449

N

National Guard, 552
 National Matches, 552
 National Match Team, 552
 National Rifle Association, 625
 Neidner .22 cal. Springfield rifle, 188
 Neidner, .30 cal. Springfield sporting
 rifle, 187
 Neidner high power bolt action rifle,
 391, 392
 Neidner chambers, 398
 Nobel, Sir Alfred, 286
 Newton high power rifles, 95

O

Octagon barrel, 133
 Offhand position, 467, 576
 Oil, castor, 611
 neatsfoot, 611
 linseed, 611
 Oil for rifles, 603
 Positions (effect on elevation, 524
 Oil made from animals, 609
 Open sights, 146
 Ordinate, 18
 Oscillation of bullets, 386

P

Panama, target range at, 610
 Phillips, General Fred H., Jr., 627,
 632
 Paste for targets, 623
 Patches, flannel cleaning, 602
 removing when stuck, 445
 Peep sights, 150
 Pistol grip, 137, 141
 Pit, target, 617
 Point blank range, 375
 Point of impact, 18
 Poldi anti-corro steel, 130
 Polishing stocks, 437
 Pope, H. M., 418
 Pope muzzle loading system, 418
 Pope rifle barrels, 419
 Pope system of rifling, 132, 419
 Positions, effect on elevation, 524
 Position and aiming drills, 501
 Positions, fring, 466
 fring, rules for, 484
 kneeling, 473
 prone, 474
 sitting, 471
 standing, 467

- Powders:**
 Modern rifle, 284
 Bulk, 302
 Bullets with, 308
 Combustion of, 294
 Compressing of, 307
 Dense, 305
 Du Pont No. 1, 332, 329
 Du Pont No. 10, 317
 Du Pont No. 13, 319, 323
 Du Pont No. 15, 318
 Du Pont No. 16, 319, 322
 Du Pont No. 18, 321
 Du Pont No. 20, 314
 Du Pont No. 21, 316, 329
 Du Pont No. 75, 334
 Du Pont No. 80, 329, 335
 Du Pont Schuetzen, 333
 for reduced loads, 311
 identification of, 311
 Hercules HiVel, 330
 Hercules Lightning, 326
 Hercules Sharpshooter, 222, 328
 Hercules W. A., 325
 manufacture of, 290
 Powder measure, 342
 Powder, measuring of, 309, 342
 nitrocellulose, 293, 300
 nitroglycerine, 292, 300
 pressure of, 297
 tables of weight, 343
 weighing, 348
 Pressures, standard, 210
 Primers, 16
 Primer pocket, 16
- R**
- Radius, mean, of groups, 429
 Rags, wiping, 602
 Range, outdoor, construction of, 614
 gallery, construction of, 506
 Ranges, location of, 615
 plan of, 616
 safety of, 614
 Rapid fire, 469, 580
 Rear sights, 154
 Rebluing barrels, 435
 Recoil, 18, 579
 Record practice, 546
 Reduced loads (see under each cartridge)
 tests with, 414
 Reloading ammunition, 338
 Reloading tools, 340
 Remington flying lock rifle, 14
 Remington-U. M. C. rifles:
 Auto-loading high power, 59
 Auto-loading .22 caliber, 74
 High-power, slide action, 65
 Repeating .22 caliber, 70
 Repairs to rifles, 432
 Repairing broken stocks, 438
 Repeating rifles, definition of, 21
 Repolishing stocks, 437
 Rest, forearm, 574
 Mann "V," 560
 muzzle and elbow, 562
 Rest shooting, 559
 Resting the rifle, 411, 574
 Rifle range construction, 614
 Rifle rest, 518
 Rifling, 131
 Roesser muzzle loading rifle, 4
 Roosevelt, Colonel, 252, 314
 Ross straight pull rifle, 91
 Rubin, Major, 13
 Running deer target, 585
- S**
- Savage rifles:
 Model, 1899, 77
 Model 1914, .22 caliber, 81
 high-power, bolt-action, 83
 Schultz powder, 12, 284
 Score book, 516, 536
 Sear, 16
 Secrets of good shooting, 456
 Sharps rifle, 8, 10
 Sharpshooter, 544
 Sharpshooter powder, 222, 328
 Shells, 16, 210, 357
 broken, extracting, 443
 cleaning of, 357
 Sights, 146
 Sight adjustment, 170, 456, 492
 Sight adjustment of gallery rifle, 498
 Sight adjustment for hunting rifles, 499, 574
 Sight adjustment, micrometer. 408, 517
 Sight adjustment rules, 172, 497
 Sight black, 515
 Sight corrections, table of, 174
 Sights for gallery use, 510
 Sight radius, 158
 Sight graduations, dimensions of, 173
 Sizing bullets, 356
 Slots in barrels, 134
 Small Arms Firing Manual, 543
 Small bore rifles, definition of, 21
 Smokeless powder, history of, 12
 Smokeless powder (see powder)
 Solution, ammonia metal fouling, 607
 ammonia swabbing, 603
 cleaning, 590
 Spencer, General Bird W., 624
 Spencer rifle, 10
 Spitzer bullets, 206
 Spitzer greaser, 408

Springfield rifle, .45 caliber, 11
 Springfield rifle (U. S. Model of 1903),
 107
 Springfield sporting rifle, Whelen
 model, 130
 Sportsmen, rifle practice for, 573
 Squeeze, trigger, 456, 486
 Stevens Ideal rifle, 89
 Steel for barrels, 129
 Still hunting maxims, 596
 Stocks, 136
 care of, 611
 checking of, 439
 repair of broken, 438
 repolishing, 437
 Storage of rifles, 612
 Stove for moulding bullets, 350
 Sulphur mould, 448

T

Target measurement, 428
 Targets for telescope sights, 196
 Targets, military, 550
 Target pit, 617
 Team, equipment for, 554
 Team shooting, 551
 Telescope, range, 517, 533
 Telescope sights, 179
 Winchester, 178, 191
 Temperature, 377, 522
 Testing rifles, 559
 Tipping bullets, 385
 Trajectory (see also under each car-
 tridge), 17, 360
 Trajectory tests, 569
 Trigger, 16
 Trigger pull, adjustment of, 432
 Trigger squeeze, 456, 486
 Tropics, care of rifle in, 612
 Twist of rifling (see also under each
 cartridge), 131

U

United States Rifle, Model 1898, 101,
 323

Model 1903, 107, 397
 Model 1917, 122

V

Velocity (see also under each car-
 tridge), 16
 Vieille, 286

W

Walnut for stocks, 136
 Weight of rifles, 144
 Whistler, Colonel, 287
 White, Stewart Edward, 253, 580
 White, S. E., rifle of, 580
 White system of rapid fire, 580
 Wilderness, rifle in, 588
 Winchester rifles:
 Model 1866, 10
 Model 1873, 11, 26
 Model 1876, 11
 Single shot, 13, 48, 248, 389, 449, 451
 Model 1886, 29
 Model 1890, 33
 Model 1892, 37
 Model 1894, 39
 Model 1895, 13, 43, 247
 Model 1903, 52
 Model 1905, 52
 Model 1906, 33
 Model 1907, 52
 Model 1910, 52, 382
 Windage, 528
 Wind allowance, table of 531
 Wind direction, 528
 Wind-gauge, 150
 Wind, mirage indication of, 533
 Wind velocity, 529
 Windgate, General George W., 625
 Winds affecting elevation, 524
 Winds, fish-tail, 530
 Wood for stocks, 136
 Worn muzzles, 449

MAR 6 - 1961



